

# UE Fading Test with the CMW500 RF Tester and the SMW200A

## Application Note

### Products:

- R&S®CMW500
- R&S®SMW200A

This application note shows how to perform user equipment (UE) receiver tests, such as block error rate (BLER) and throughput tests, under fading conditions with the R&S®CMW500 RF tester and the R&S®SMW200A vector signal generator in LTE(-A), W-CDMA (HSPA+), TD-SCDMA, GSM (GRPS and EGPRS(2)), CDMA2000 and 1xEV-DO.

### Note:

Please find the most up-to-date document on our homepage <http://www.rohde-schwarz.com/appnote/1MA194>.

# Table of Contents

<b>1</b>	<b>Introduction</b>	<b>5</b>
<b>2</b>	<b>Measurement Setup</b>	<b>7</b>
2.1.1	Fading Test Setup for One Baseband Signal	7
2.1.2	Fading Test Setup for Two Basebands Signals	8
2.1.3	Fading Test Setup for Four Basebands Signals	8
2.1.4	Fading Test Setup for more than four Basebands Signals	9
<b>2.2</b>	<b>Dig IQ connectors at the CMW</b>	<b>9</b>
<b>2.3</b>	<b>SMW Configuration</b>	<b>10</b>
2.3.1	System Configuration / MIMO Settings	10
2.3.2	External Reference	14
2.3.3	Digital input	15
2.3.4	Digital output	16
2.3.5	Display settings (AMU only)	18
2.3.6	Fading settings	18
2.3.7	AWGN settings	22
2.3.8	Compensation of necessary attenuation	23
<b>3</b>	<b>LTE(-A) Measurements</b>	<b>26</b>
<b>3.1</b>	<b>UE Receiver Measurement in LTE: Extended BLER</b>	<b>27</b>
<b>3.2</b>	<b>Scenarios for one cell</b>	<b>29</b>
3.2.1	“1 Cell – Fading – 1 RF Out” scenario (SISO)	29
3.2.2	“1 Cell – Fading – 2 RF Out” scenario (MIMO)	34
3.2.3	“1 Cell – Fading – MIMO 4x2 2 RF Out” scenario (4x2 MIMO)	51
<b>3.3</b>	<b>Scenarios for Carrier Aggregation</b>	<b>55</b>
3.3.1	“2CC CA – Fading – 2 RF Out” scenario (CA with SISO)	55
3.3.2	“2CC CA – Fading – 4 RF Out” scenario (CA with MIMO)	60
<b>3.4</b>	<b>Scenarios for Carrier Aggregation with CMWflexx</b>	<b>64</b>
3.4.1	“2CC CA – Fading – 4 RF Out Distributed” scenario (CA with MIMO)	64
3.4.2	“3CC CA – Fading – 6 RF Out” scenario (CA with 3 CC’s and MIMO)	65
3.4.3	“4CC CA – Fading – 8 RF Out” scenario (CA with 4 CC’s and MIMO)	69
<b>3.5</b>	<b>CMW Internal Fading for LTE(-A)</b>	<b>73</b>
<b>4</b>	<b>W-CDMA and HSPA(+) Measurements</b>	<b>76</b>

4.1	UE Receiver Measurement in W-CDMA: Rx Meas .....	77
4.2	SISO Configuration .....	80
4.3	Rx Diversity Configuration (SIMO) .....	84
4.4	Dual-Carrier Configuration (DC-HSPA+) .....	87
4.5	DC-HSPA+ with Rx Diversity Configuration .....	91
4.6	Dual-Band HSDPA Configuration (DB-DC-HSPA+) .....	94
4.7	Dual Band HSDPA with Rx Diversity Configuration (DB-DC-HSPA+ with Rx Diversity) .....	99
4.8	CMW Internal Fading for W-CDMA and HSPA(+) .....	102
<b>5</b>	<b>GSM and (E)GPRS(2) Measurements .....</b>	<b>105</b>
5.1	Mobile Station Receiver Measurement in GSM: Rx Meas .....	108
5.2	Fading Scenario .....	112
5.3	Fading with Hopping (single DL carrier) .....	116
5.4	Fading with DL Dual Carrier .....	121
5.5	CMW Internal Fading for GSM and (E)GPRS(2) .....	122
<b>6</b>	<b>TD-SCDMA Measurements .....</b>	<b>125</b>
6.1	UE Receiver Measurement in TD-SCDMA: Rx Meas .....	125
6.2	Fading Scenario .....	126
<b>7</b>	<b>CDMA2000 and 1xEV-DO Measurements .....</b>	<b>129</b>
7.1	CDMA2000 .....	129
7.1.1	Mobile Station Receiver Measurement in CDMA2000: Rx Meas .....	130
7.1.2	Fading Scenario .....	133
7.1.3	CMW Internal Fading for CDMA2000 .....	135
7.2	1xEV-DO .....	137
7.2.1	Access Terminal Receiver Measurement in 1xEV-DO: Rx Meas .....	138
7.2.2	Fading Scenario .....	140
7.2.3	CMW Internal Fading for 1xEV-DO .....	143
<b>8</b>	<b>Data Application Unit (DAU) .....</b>	<b>145</b>
8.1	LTE .....	148
8.2	W-CDMA and with HSPA(+) .....	148
8.3	GSM and (E)GPRS(2) .....	150
8.4	TD-SCDMA .....	150
8.5	CDMA2000 and 1XEV-DO .....	151
<b>9</b>	<b>Appendix .....</b>	<b>154</b>

**9.1 Literature .....154**  
**9.2 Additional Information .....154**  
**9.3 Ordering Information .....155**

# 1 Introduction

The R&S®CMW500 wideband radio communication tester can be used throughout all phases of UE device development. It supports different mobile standards, such as LTE(-A) (FDD and TDD), W-CDMA (HSPA+, TD-SCDMA), GSM (including GPRS, EDGE and EGPRS(2) and VAMOS), CDMA2000 and 1xEV-DO.

Testing under real propagation conditions is important for UE receiver sensitivity tests. The measurement type depends on the mobile standard, e.g. a bit-error rate (BER) or a block-error rate (BLER). The throughput can be calculated directly from the BLER.

The CMW offers internal fading for different standards as options:

- LTE (CMW-KE500)
- W-CDMA (CMW-KE400)
- GSM (CMW-KE200)
- CDMA2000/1xEV-DO (CMW-KE800)
- AWGN (CMW-KE100)

Supported fading				
Technology			Internal Fading	External Fading with SMW
LTE (-A) (FDD and TDD)	Predefined profiles acc. 3GPP.TS 36.101 Annex B		<input checked="" type="checkbox"/>	<input checked="" type="checkbox"/>
	Full user-defined fading settings			<input checked="" type="checkbox"/>
3GPP	W-CDMA	Predefined profiles acc. 3GPP.TS 25.101 Annex B	<input checked="" type="checkbox"/>	<input checked="" type="checkbox"/>
		Full user-defined fading settings		<input checked="" type="checkbox"/>
	TD-SCDMA	Predefined profiles acc. 3GPP.TS 25.101 Annex B		<input checked="" type="checkbox"/>
		Full user-defined fading settings		<input checked="" type="checkbox"/>
3GPP2	CDMA2000	Predefined profiles acc. 3GPP2 C.S0011	<input checked="" type="checkbox"/>	<input checked="" type="checkbox"/>
		Full user-defined fading settings		<input checked="" type="checkbox"/>
	1xEV-DO	Predefined profiles acc. 3GPP2 C.S0033	<input checked="" type="checkbox"/>	<input checked="" type="checkbox"/>
		Full user-defined fading settings		<input checked="" type="checkbox"/>
GSM	Predefined profiles acc. 3GPP.TS 45.005 Annex C		<input checked="" type="checkbox"/>	<input checked="" type="checkbox"/>
	Full user-defined fading settings and hopping			<input checked="" type="checkbox"/>

The combination of the CMW500 wideband radio communication tester as base station simulator and the SMW200A vector signal generator offers full user-defined channel simulation, including fading for SISO and MIMO scenarios, as well as noise.

This application note shows the test setups for external fading, explains the settings required for the various measurement configurations, such as Rx diversity and MIMO for LTE, W-CDMA, GSM and TD-SCDMA. In addition, it specifies the most important remote commands along the way.

The CMW is able to perform fading internally with predefined fading profiles. This application note also explains for every standard the internal fading settings briefly.

The AMU200A baseband and fading simulator can also be used to provide the external fading. Please note that the here shown screenshots and settings apply for the SMW200A. Possible differences are explained in the particular sections.

The following abbreviations are used in the following text for R&S® test equipment:

- The R&S® CMW500 wideband radio communication tester is referred to as CMW.
- The R&S® SMW200A vector signal generator is referred to as SMW.
- The R&S® AMU200A fading simulator is referred to as AMU.
- R&S® refers to Rohde & Schwarz GmbH und Co KG.

## 2 Measurement Setup

This chapter deals with the measurement setup for external fading with the SMW. For internal fading with the CMW only, no special setup is needed.

Fading and AWGN characteristics are applied in the SMW. To do this, it is necessary to feed the CMW's digital baseband signals through the SMW.

### 2.1.1 Fading Test Setup for One Baseband Signal

The following figure shows the setup for SISO-based measurements.

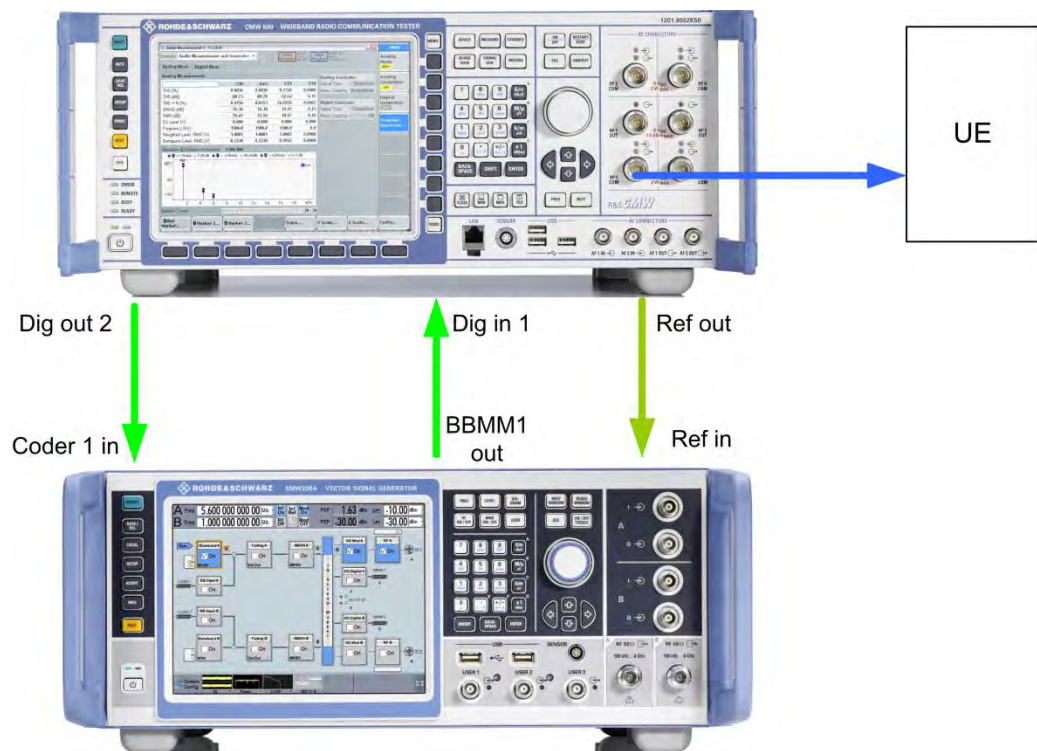

Fig. 2-1: Hardware configuration for UE terminal test under SISO fading conditions.

The SMW is connected to the CMW via the digital baseband Coder 1 in input and BBMM 1 output.

The AMU is connected to the CMW via the digital baseband input and output A.

### 2.1.2 Fading Test Setup for Two Basebands Signals

The following figure shows a setup with two baseband signals, which is required for scenarios using two basebands, such as MIMO or dual carrier. Please note that there are two possible configurations for the RF frontends available:

- Two FE basic (FE1 basic (CMW-S590A) + FE2 basic (CMW-B590A))
- Or
- One FE1 advanced (CMW-S590D)

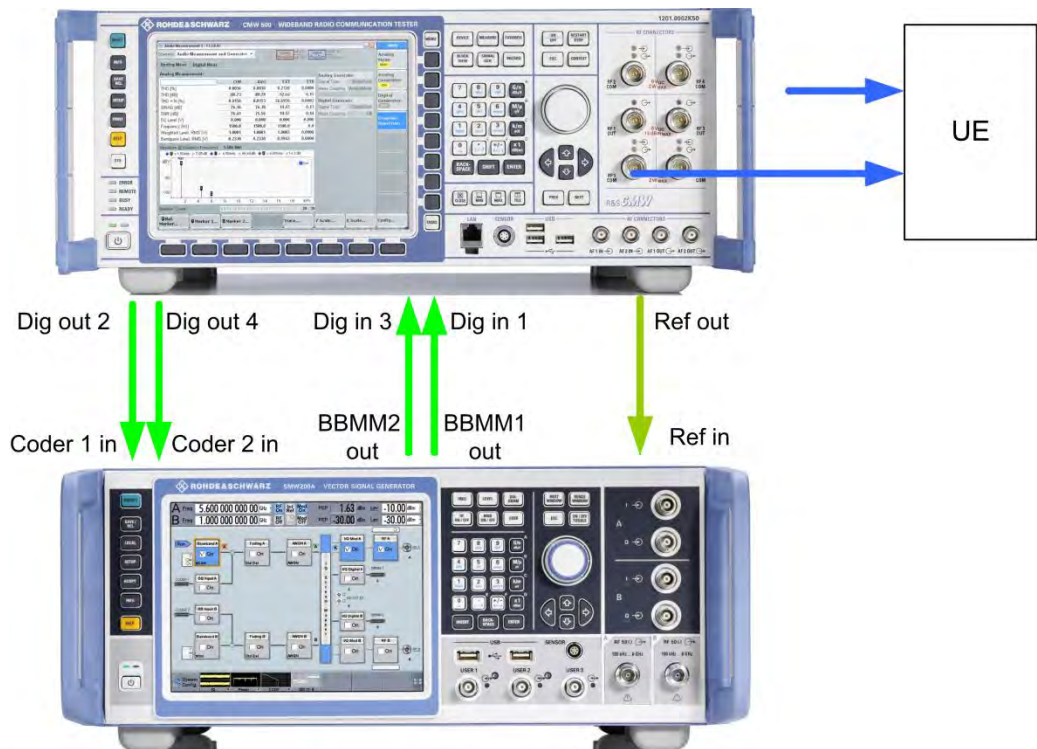

Fig. 2-2: Hardware configuration for UE terminal test with two RF ports.

The SMW is connected to the CMW via two digital baseband Coder 1/2 inputs and BBMM 1/2 outputs.

The AMU is connected to the CMW via two digital baseband inputs and outputs A and B.

### 2.1.3 Fading Test Setup for Four Basebands Signals

The following figure shows a setup with four baseband signals, which is required for scenarios using four basebands, such as carrier aggregation with MIMO. Please note that here two FE1 advanced (CMW-S590D) and two Digital IQ Interfaces (CMW-B510F and CMW-B520F) are necessary in the CMW and one SMW is needed for the fading.



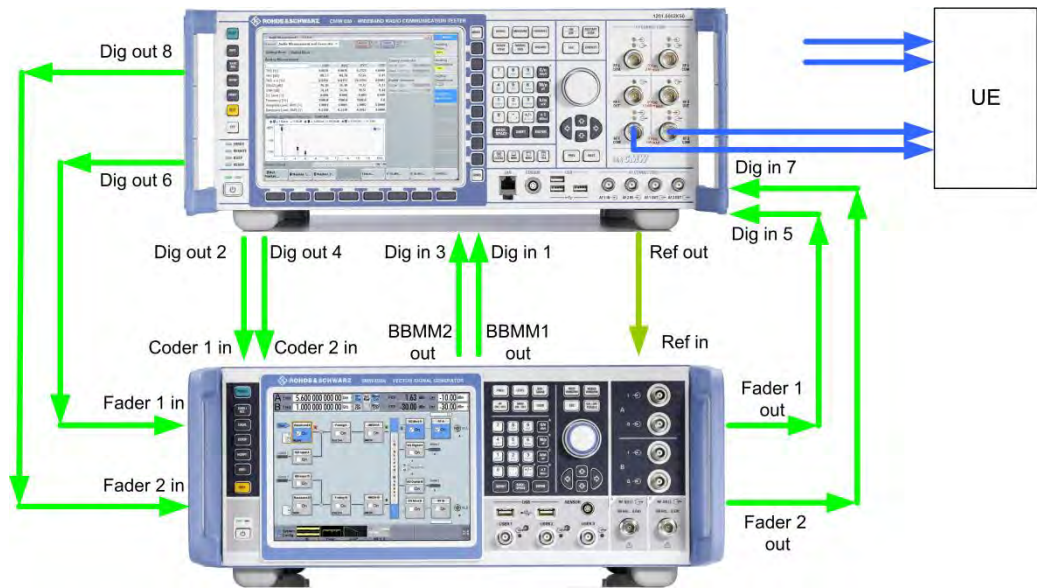

Fig. 2-3: Hardware configuration for UE terminal tests with four RF ports.

The SMW is connected to the CMW via two digital baseband Coder 1/2 inputs and BBMM 1/2 outputs and the Fader 1/2 inputs and outputs.

The AMU is connected to the CMW via two digital baseband inputs and outputs A and B. Two AMU's are needed.

### 2.1.4 Fading Test Setup for more than four Basebands Signals

The combination of one CMW and one SMW allows fading for up to 4 baseband signals, e.g. carrier aggregation with 2CC, both with 2x2 MIMO. If more than the four baseband signals are needed the CMWflex solution allows to combine two or more CMW's, each with four basebands signals. In addition two or more SMW's provide the fading.

The test setup of 2.1.3 for four baseband signals is multiplied by the number of used CMW's.

A scenario with carrier aggregation with 4 CC's and 2x2 MIMO thus needs a CMWflex setup with two CMW's and thus in addition two SMW's. The digital connections between the CMW and the corresponding SMW are needed twice.

To provide the signals to the UE, an additional RF combiner (e.g. CMW-Z24) may be needed.

## 2.2 Dig IQ connectors at the CMW

Here, a single or first signal is fed through DIG IQ OUT 2 via Baseband A and DIG IQ IN/OUT 1. A second signal is sent accordingly through DIG IQ OUT 4 via Baseband B and DIG IQ IN/OUT 3.

Fig. 2-4 shows the CMW digital baseband connection. A single signal (SISO tests or one carrier) needs input and output A, while using two signals (MIMO or dual carrier) requires input and output A and B.

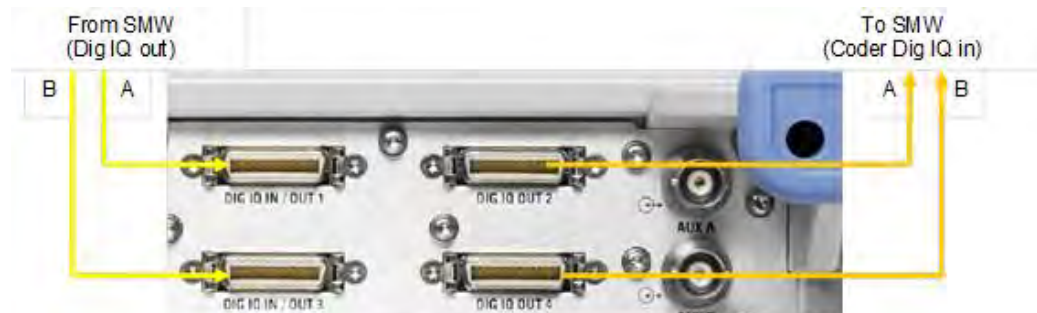

Fig. 2-4: CMW: Digital In / Out.

If needed, the signals three and four are handled via DIG IQ OUT 6 and DIG IQ IN/OUT 5 respectively DIG IQ OUT 8 and DIG IQ IN/OUT 7.

Detailed configuration information for the SMW and CMW can be found at the end of this application note.

## 2.3 SMW Configuration

### 2.3.1 System Configuration / MIMO Settings

With tests that use MIMO, it is also necessary to fade the cross components between the antennas. For a 2x2 MIMO test, for example, it is necessary to simulate a total of four paths.

#### SMW

The SMW is able to handle up to four basebands and up to four RF paths. Thus a tool **System Configuration** handles the MIMO settings.

In the description of the scenarios special settings are described.

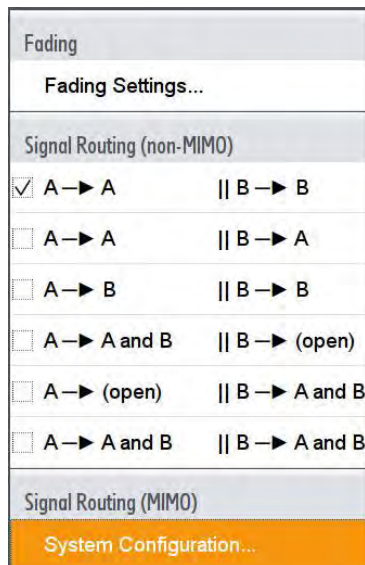

Fig. 2-5: Calling the System Configuration to handle MIMO settings

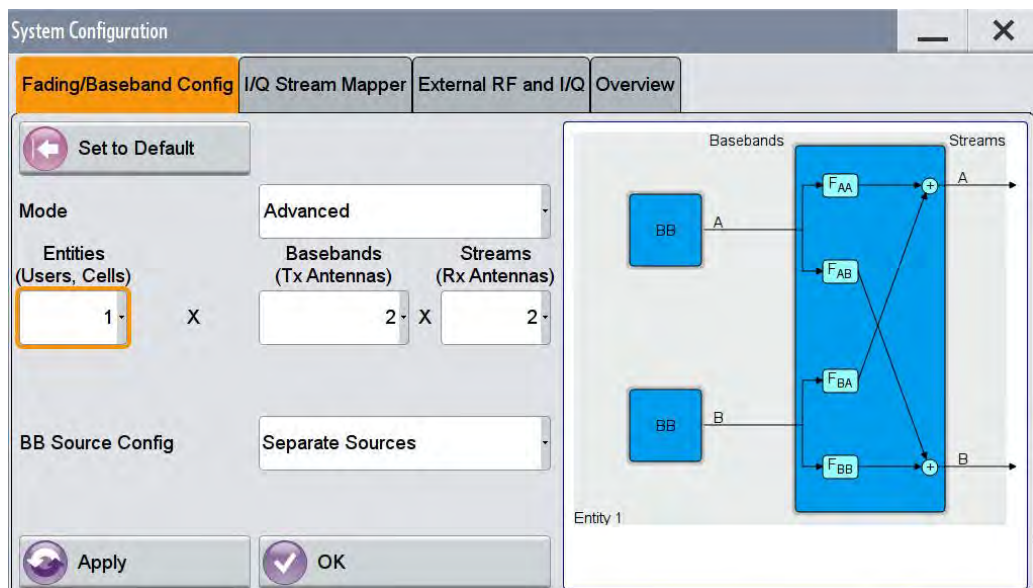

Fig. 2-6: Setting basebands and MIMO routings in the System Configuration (example: 2x2 MIMO)

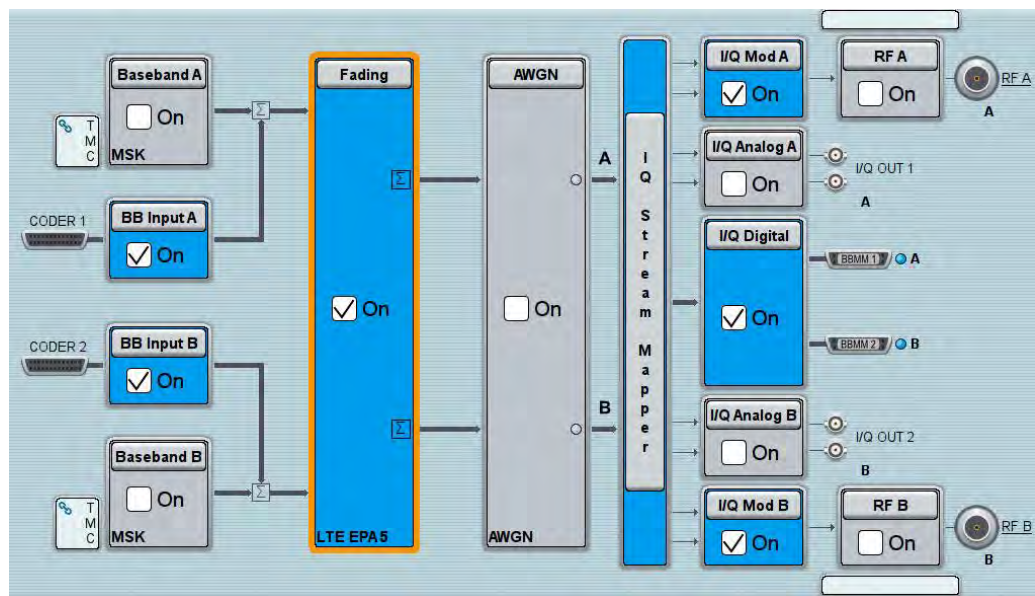

Fig. 2-7: Overview SMW 2x2 MIMO fading scenario.

Remote commands SMW:

```
:SCONfiguration:MODE ADVanced           // Advanced mode
:SCONfiguration:FADing MIMO2x2          // 2x2 MIMO
```

Select the desired fading standards in the LTE MIMO menu, e.g. *EPA 5 Hz Low* (Enhanced Pedestrian A, low correlation), or use individual settings.

Remote commands SMW:

```
SOURcel1|2:FSIMulator:STANDARD LMEPA5L
```

## AMU

Select **2x2 MIMO** in the Fading A (or B) **config...** menu.

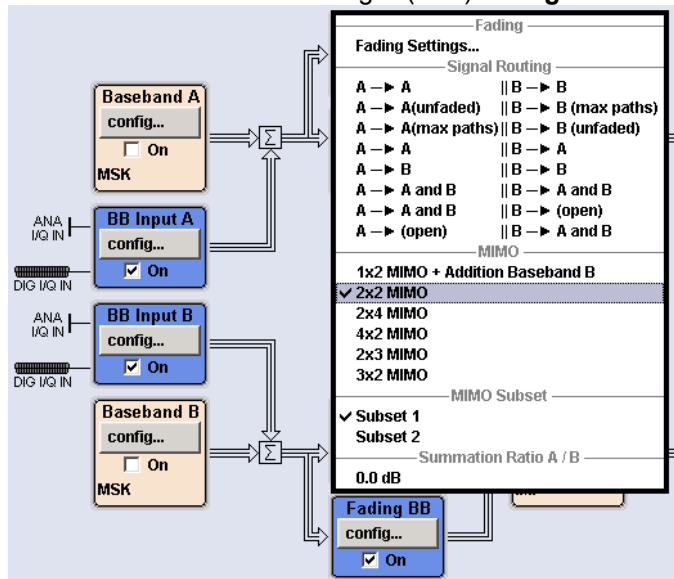

Fig. 2-8: 2x2 MIMO scenario AMU

### Remote commands AMU:

```
SOUR:FSIM:ROUT FA1A2BFB1A2BM24
```

Select the desired fading standards in the LTE MIMO menu, e.g. *EPA 5 Hz Low* (Enhanced Pedestrian A, low correlation), or use individual settings.

### Remote commands AMU:

```
SOURcel|2:FSIMulator:STANdard LMEPA5L
```

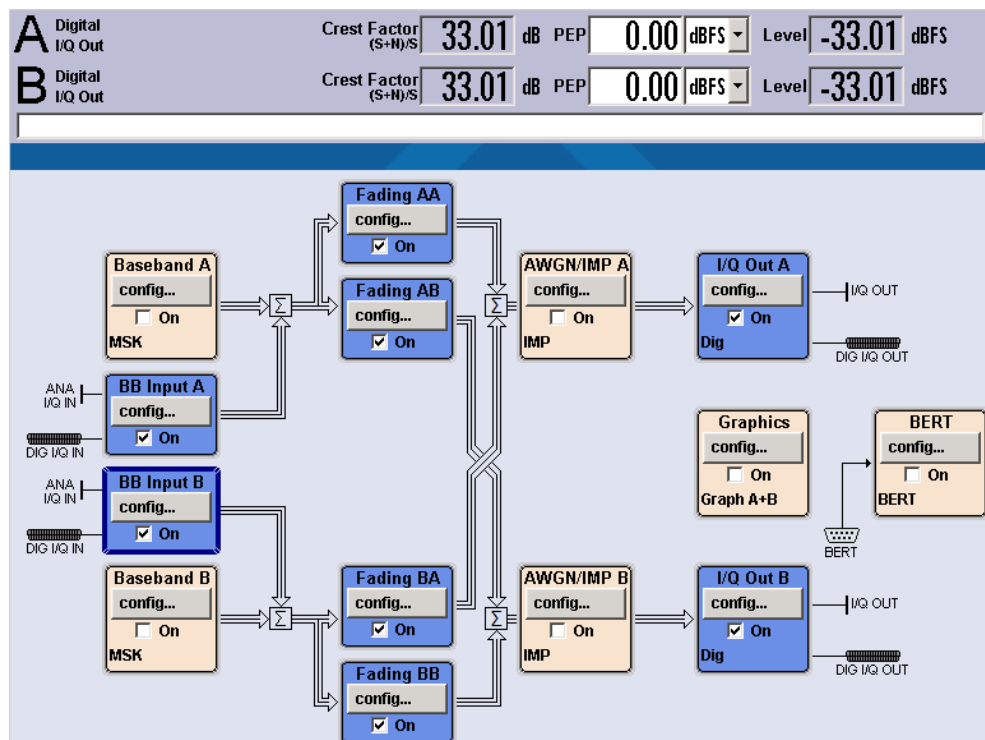

Fig. 2-9: Overview AMU 2x2 MIMO fading scenario.

*Note:* A setting change in one of the fading blocks (Fading AA, AB, BA or BB) also always applies to all other blocks.

### 2.3.2 External Reference

The SMW needs to be synchronized by connecting the CMW Ref1 Out to the SMW Ref In. The SMW must be set to external reference in the menu **Setup**.

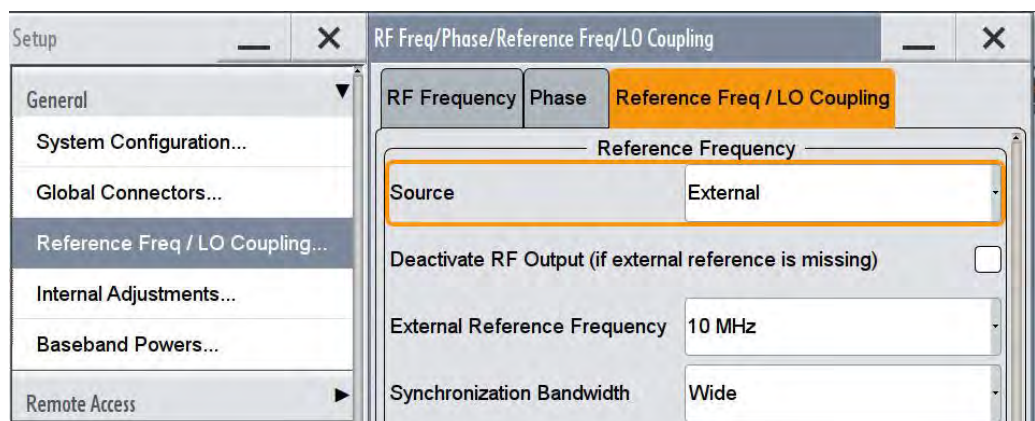

Fig. 2-10: External reference.

### 2.3.3 Digital input

Two important criteria of the baseband signal are the crest factor and the PEP (peak envelope power). The PEP of the digital LTE baseband signal coming from the CMW is defined as 0 dBFS (= dB Full Scale, the level ratio of the signal to the maximum possible voltage of I or Q, e.g.  $0.5 V_p = 1 V_{pp}$  [peak to peak]). The crest factor is the ratio between the PEP and (RMS) Level.

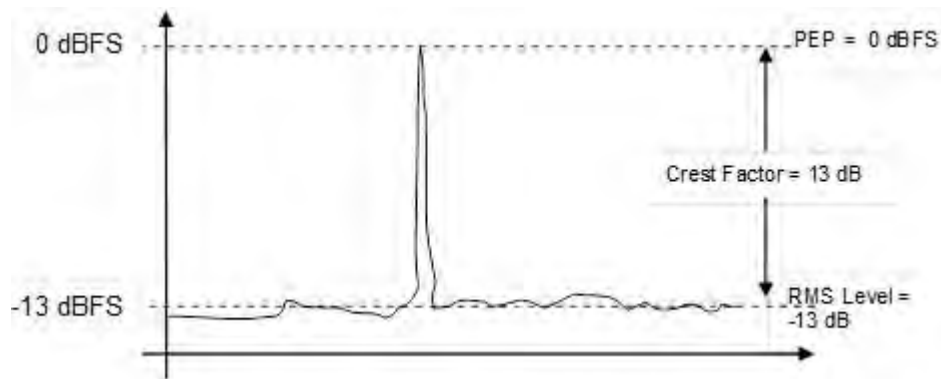

Fig. 2-11: PEP, RMS level and crest factor.

The signal at the CMW digital baseband output depends on the mobile standard and is shown in the SIGNALING application under IQ Settings | Crest Factor. In the example for LTE signaling in Fig. 2-12, it is 15 dB.

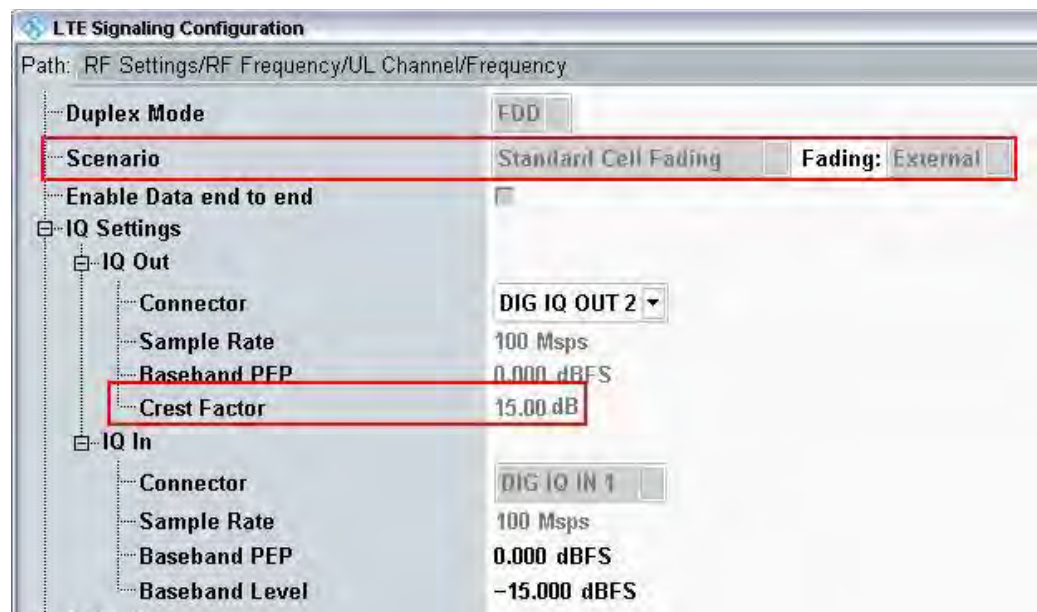

Fig. 2-12: The Crest factor depends on the mobile standard, and the CMW indicates its value.

The crest factor must be taken into account when adjusting the digital input to the SMW. The SMW BB Coder 1 (and Coder 2 for MIMO) must be set to 0 dBFS PEP, and the crest factor must be set as determined above (15 dB in this example).

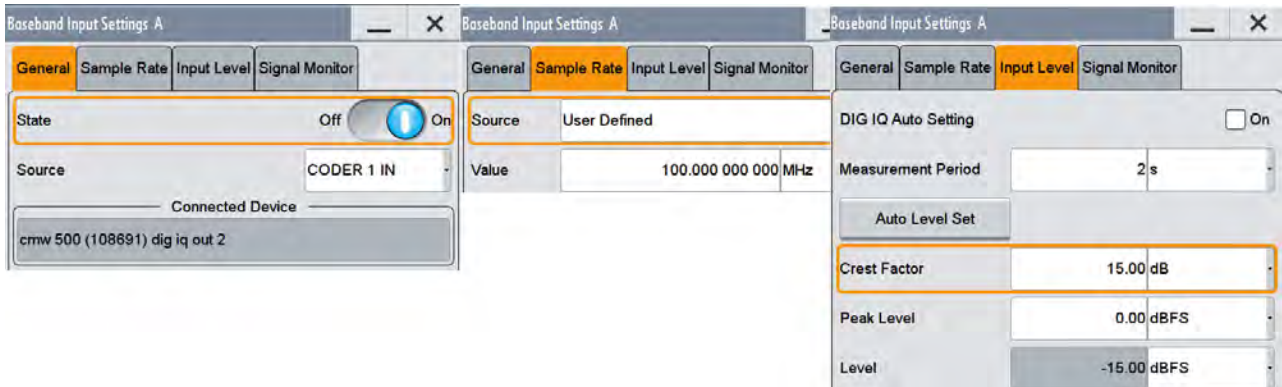

Fig. 2-13: SMW Baseband Input Settings.

#### Remote commands SMW:

```

SOURCE1|2:BBIN:DIGital:SOURce CODER1 // Select Coder 1
SOURCE1|2:BBIN:STATe ON // Turn Input On
SOURCE1|2:BBIN:MODE DIGital // Digital Input Mode
SOURCE1|2:BBIN:SRATe:SOURce USER // Digital Input Mode
SOURCE1|2:BBIN:SRAT 100MHz // 100 MHz sample rate
SOURCE1|2:BBIN:CFACTOR 15.00 // Set 15 dB Crest Factor
SOURCE1|2:BBIN:POWer:PEAK 0.00 // Set 0 dBFS PEP

```

#### Remote commands AMU:

```

SOURCE1|2:BBIN:STATe ON // Turn Baseband A|B Inp. ON
SOURCE1|2:BBIN:MODE DIGital // Select Digital Input Mode
SOURCE1|2:BBIN:SRATe:SOURce USER // Select Digital Input Mode
SOURCE1|2:BBIN:SRAT 100MHz // 100 MHz sample rate
SOURCE1|2:BBIN:CFACTOR 15.00 // Set 15 dB Crest Factor
SOURCE1|2:BBIN:POWer:PEAK 0.00 // Set 0 dBFS PEP

```

### 2.3.4 Digital output

The digital I/Q output BBMM1 (and BBMM2 for MIMO; A and B for the AMU) must be turned ON, and the PEP must be set to the same value as at the input (0.00 dBFS). Set the output sample rate to 100 MHz.



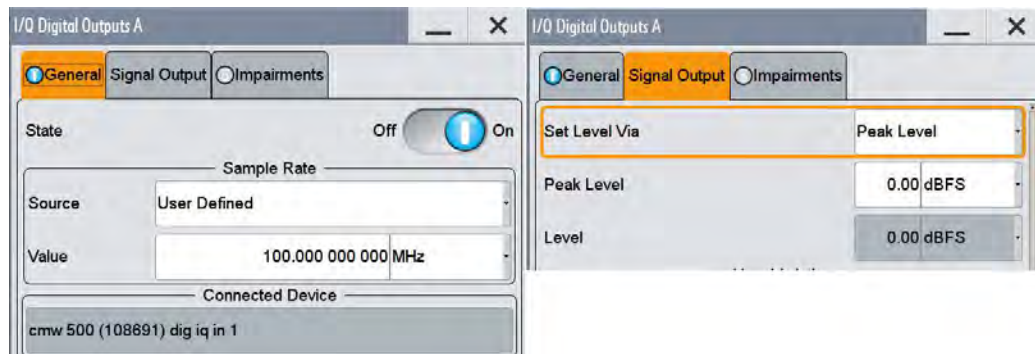

Fig. 2-14: Digital I/Q Output Settings.

Remote commands SMW:

```
SOURce:IQ:OUTPut:DIGital:BBMM1|2:SRATe:SOURce USER
SOURce:IQ:OUTPut:DIGital:BBMM1|2:SRAT 100MHz
SOURce:IQ:OUTPut:DIGital:BBMM1|2:POWer:VIA PEP
SOURce:IQ:OUTPut:DIGital:BBMM1|2:POWer:PEP 0 // PEP = 0 dBFS
SOURce:IQ:OUTPut:DIGital:BBMM1|2::STATe ON // BB ON
```

Remote commands AMU:

```
SOURce1|2:IQ:OUTPut:DIGital:SRATe:SOURce USER
SOURce1|2:IQ:OUTPut:SRAT 100MHz // 100 MHz sample rate
SOURce1|2:IQ:OUTPut:POWer:VIA PEP
SOURce1|2:IQ:OUTPut:DIGital:POWer:PEP 0 // Set PEP = 0 dBFS
SOURce1|2:IQ:OUTPut:DIGital:STATe ON // BB A|B dig. outp ON
```

### 2.3.5 Display settings (AMU only)

In the **I/Q OUT SETTINGS** menu, select **LEVEL DISPLAY SETTINGS...** to easily read the output level.

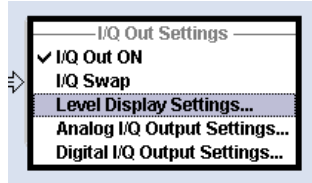

Fig. 2-15: Level Display Settings AMU

Set the **AUXILIARY INFORMATION** parameter in the **LEVEL DISPLAY SETTINGS A** (and B for MIMO) menu to **CREST FACTOR ((S+N)/S)**. This crest factor indicates the ratio of the signal's peak value plus noise to the signal's RMS level without noise.

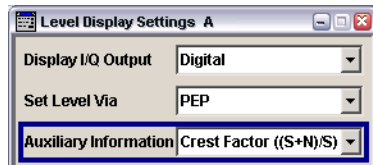

Fig. 2-16: Level Display Settings AMU

Remote commands AMU:

```
SOURce1|2:IQ:OUTPut:DISPlay DIGITal
SOURce1|2:IQ:OUTPut:DISPlay:AINformation CFSN
```

### 2.3.6 Fading settings

In principle, up to two baseband signals can be subjected to fading and AWGN in the SMW. In addition, it is possible to select different MIMO configurations.

For the fading functionality, there are pre-defined scenarios in line with the specifications of the various wireless standards (for example, LTE EVA 5 Hz). In such cases, there is no need to configure any further settings. In addition, for tests that go beyond these requirements, it is also possible to set all of the fading parameters individually.

In the **Fading** block, configure the **Fading Settings**. You can either choose *Standard* to conveniently select predefined scenarios (Fig. 2-18 and Fig. 2-19) or choose *User* to modify the individual parameters by implementing custom settings.

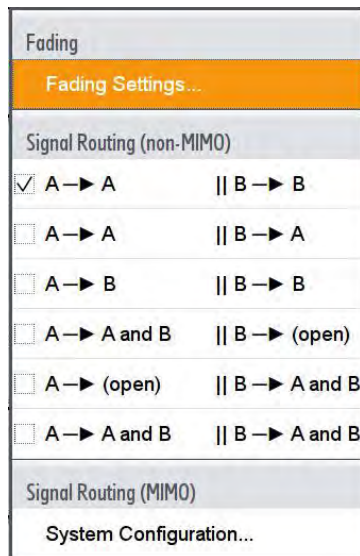

Fig. 2-17: Block Fading: fading settings.

Remote command:

`SOURcel|2:FSIMulator:STANdard xxx`

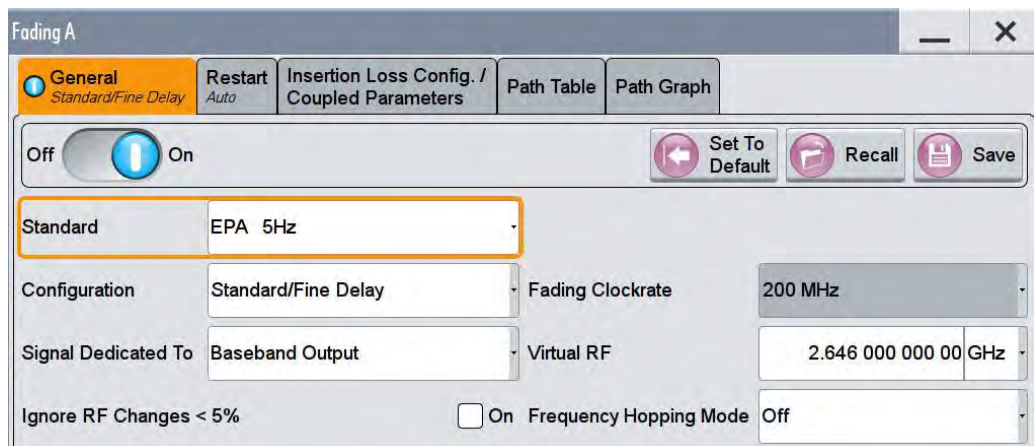

Fig. 2-18: The selection of pre-defined fading profiles.



Fig. 2-19: Available pre-defined fading profiles (“standards”)

	Unit	1 1	2 2	3 3	4 4
State		On	On	On	On
Profile		Rayleigh	Rayleigh	Rayleigh	Rayleigh
Path Loss /dB		0.00	1.00	2.00	3.00
Basic Delay /μs	μs	0.000 000	0.000 000	0.000 000	0.000 000
Additional Delay /μs	μs	0.000 000	0.030 000	0.070 000	0.090 000
Resulting Delay /μs	μs	0.000 000	0.030 000	0.070 000	0.090 000

Fig. 2-20: Path Table: Detailed settings for multiple paths.



Fig. 2-21: Path Graph: Detailed graphically presentation.

If a second path is used, also configure the fading accordingly in Path B.

### RF Frequency

The Fading Simulator needs to know the CMW's RF frequency in order to calculate Doppler-based fading standards correctly (e.g. 2.646 GHz). There are two possible ways:

#### Virtual RF

This case is used in the AMU and can be used in the SMW. In the SMW set **Signal Dedicated to Baseband Output**, then set the **Virtual RF** in the fading simulator.

Remote commands SMW:

```
SOURcel1|2:FSIMulator:SDESTINATION BB // Destination Baseband
SOURcel1|2:FSIMulator:FREQUENCY 2646MHz // Virtual RF
```

Remote commands AMU:

```
SOURcel1|2:FSIMulator:FREQUENCY 2646MHz //Virtual RF
```

#### RF

This case is used in the SMW only. Set **Signal Dedicated to RF**, then set the *general RF frequency* as usual.

Remote commands SMW:

```
SOURcel1|2:FSIMulator:SDESTINATION RF // Destination RF
SOURcel1|2:FREQUENCY 2646MHz // general RF
```

### Enable Fading

Turn fading ON.

Remote command:

```
SOURce1|2:FSIMulator:STATE ON
```

## 2.3.7 AWGN settings

Click on **AWGN** in the AWGN block.

In the AWGN menu, set the System Bandwidth (e.g. 10 MHz), the desired Signal/Noise Ratio (e.g. 0.00 dB) and turn the *State ON*.

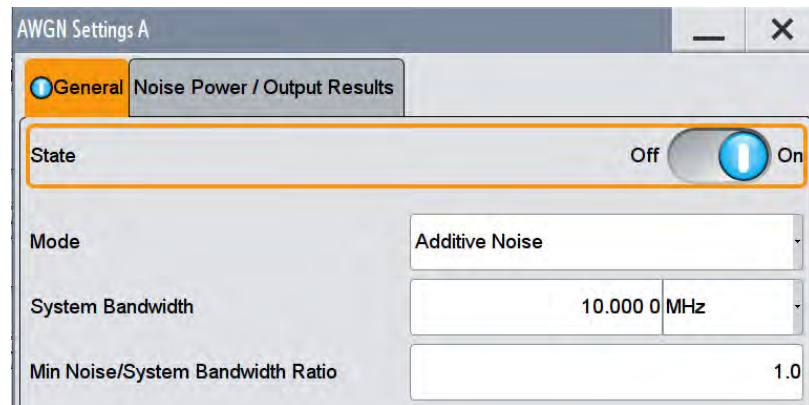

Fig. 2-22: AWGN settings general

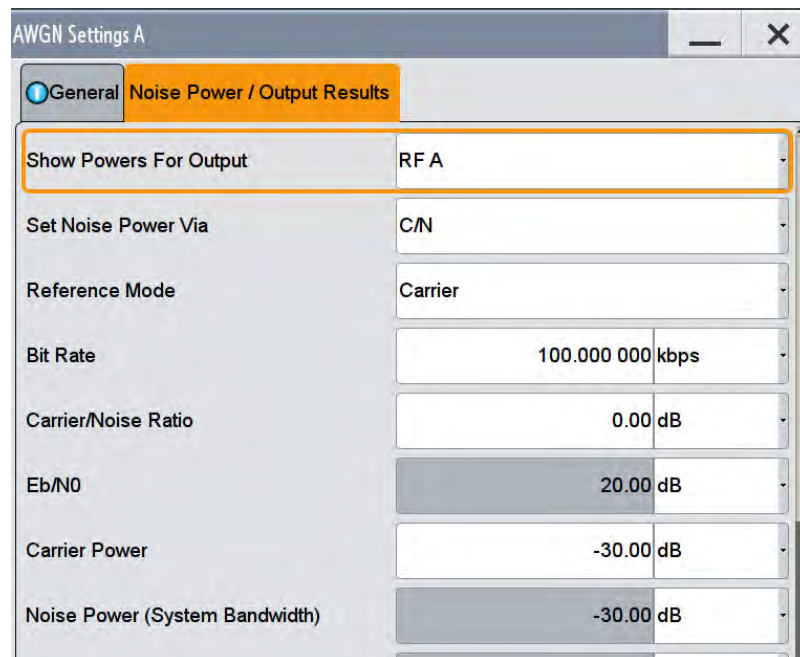

Fig. 2-23: AWGN settings power

Remote commands:

```

SOURce1|2:AWGN:MODE ADD           // Additive noise
SOURce1|2:AWGN:BWID 10 MHz        // bandwidth
SOURce1|2:AWGN:BWID:RAT 1.0       // bandwidth
SOURce1|2:AWGN:POWer:MODE SN      // Power mode signal to noise

SOURce1|2:AWGN:SNR 0.0 dB         // SNR
SOURce1|2:AWGN ON                 // switch ON

```

### 2.3.8 Compensation of necessary attenuation

A faded signal has a higher crest factor than an unfaded signal has. In order to avoid distortion, the signal must be attenuated before entering the fading unit. The necessary attenuation depends on the fading standard and on the AWGN level and is calculated and displayed by the fading simulator.

The attenuation in the baseband must be compensated in the CMW. This can be done easily by setting the CMW IQ Input level to the calculated SMW IQ Output level.

Changing the input level or fading profile settings on the SMW affects the necessary attenuation, and this must be compensated on the CMW as shown in [Fig. 2-26](#) **before** a throughput measurement or any other measurement is performed!

#### Display SMW

The SMW shows the calculated insertion loss in the fading block ([Fig. 2-24](#)).

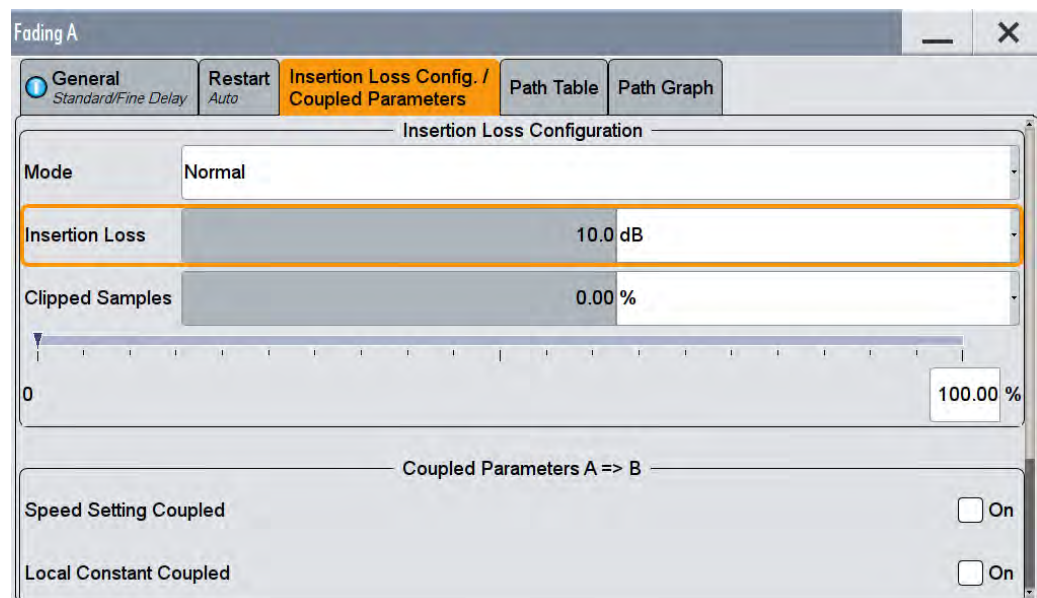

Fig. 2-24: SMW displays the calculated insertion loss

Remote commands SMW:

```

SOURce1|2:FSIMulator:ILOSs? // read insertion loss

```

The complete baseband level to be entered in the CMW calculates via:

$$\text{Level BB}_{\text{out SMW}} = \text{Crest Factor}_{\text{In SMW}} - \text{Insertion Loss}$$

In our example:

$$\text{Level BB}_{\text{out SMW}} = -15 \text{ dB} - 10 \text{ dB} = -25 \text{ dBFS}$$

### Display AMU

The AMU shows the calculated level in the main screen directly (Fig. 2-25) (for the Display configuration see 2.3.5).

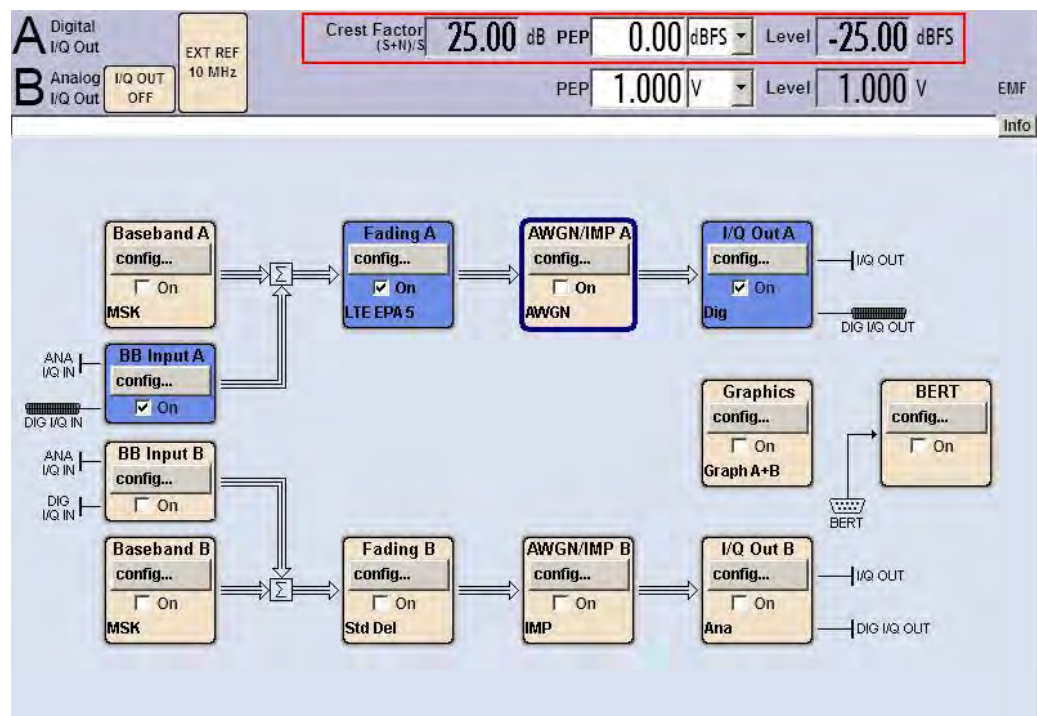

Fig. 2-25: AMU settings for SISO fading. The displayed level has to be entered in the CMW.

### Remote commands AMU:

```
SOURce1|2:IQ:OUTPut:DIGital:POWer:LEVel? // read level
```



### Compensation in the CMW

The baseband output level of the SMW has to be entered in the CMW as the input level.

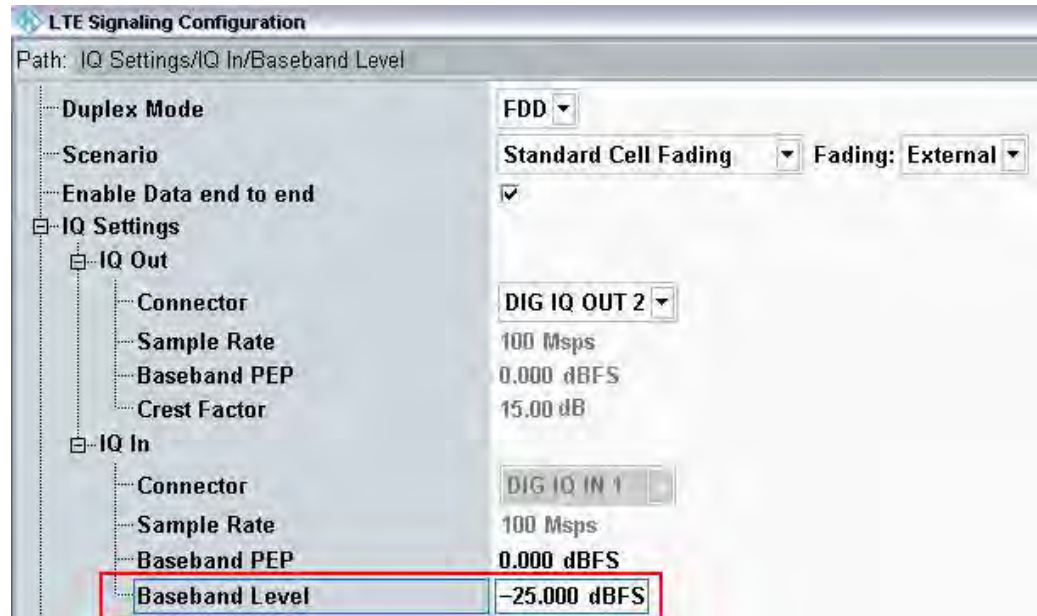

Fig. 2-26: Making allowance for the necessary attenuation from the SMW in the CMW. Here, the SMW signal's level (without AWGN) must be entered as the IQ In level.

**Note:** The fading profile and AWGN settings should not be changed during an active connection, since doing that affects the DL power, which may lead to a call drop. Always set the fading profile and AWGN before establishing the connection.

### 3 LTE(-A) Measurements

The CMW supports both FDD and TDD (TD-LTE) duplexing modes.

With the LTE standard, the UE receiver measurements include BLER, throughput and channel quality index (CQI). All measurements are summarized in the **Extended BLER** measurement application (see 3.1).

Before starting the LTE signaling, external fading must be selected as the scenario. Once signaling has begun, or once a connection has been established with the DUT, it is no longer possible to change scenarios.

Different antenna configurations (transmission modes, TM) are possible with LTE. The CMW supports following TM's:

LTE Transmission modes in the CMW	
TM	Description
1	SISO, Rx Diversity
2	Tx Diversity
3	Open loop spatial multiplexing CCD
4	Closed loop spatial multiplexing
6	Closed loop spatial multiplexing, single layer
7	Single layer beamforming
8	Dual layer beamforming
9	Dual layer beamforming

Table 3-1: TM's in the CMW

These transmission modes also require different ways of handling fading:

LTE Fading Scenarios				
CMW Configuration	TM	DCI	Description	Remark
1 Cell – Fading- 1 RF out	1	1A	SISO	Single Tx antenna port 0
	7	1	Single layer beamforming	Single Tx antenna port 5
2CC CA – Fading – 2 RF out (PCC and SCC1)				
1 Cell – Fading- 2 RF out	1	1A	Rx Diversity	SIMO, 1 x 2 (per CC)
	2	1A	Tx Diversity	MISO, 2 x 1 (per CC)
	3	1A	Tx Diversity	MISO, 2 x 1 (per CC)
		2A	Open loop spatial multiplexing CCD	MIMO, 2 x 2 (per CC)
2CC CA – Fading – 4 RF out (PCC and SCC1)	4	2	Closed loop spatial multiplexing	MIMO, 2 x 2 (per CC)
	6	1B	Closed loop spatial multiplexing single layer	MIMO, 2 x 2 (per CC)
2CC CA – Fading – 4 RF out distributed (PCC and SCC1)				
3CC CA – Fading – 6 RF out (PCC, SCC1 and SCC2)	7	1	Single layer beamforming	Single Tx antenna port 5
	8	2B	Dual layer beamforming	Tx antenna ports 7 and 8
4CC CA – Fading – 8 RF out (PCC, SCC1, SCC2 and SCC3)				
1 Cell 4x2 MIMO Fading 2 RF out	2, 3, 4, 6		4x2 MIMO	

Table 3-2: LTE scenarios in the CMW.

This section describes the necessary steps to perform an LTE Rx measurement under several conditions, such as SISO or 2x2 MIMO fading.

For further information on LTE signaling and extended BLER measurements, refer to [5].

### 3.1 UE Receiver Measurement in LTE: Extended BLER

The CMW sends data to the UE via PDSCH subframes and determines the block error rate (BLER) from the positive ACKnowledgments (ACK) and negative ACKnowledgments (NACK) returned by the UE. Additional throughput results are calculated from the BLER results. The CQI indices reported by the UE are also evaluated.

Fig. 3-1 through Fig. 3-4 show examples of the different measurements under fading conditions.



Fig. 3-1: LTE Extended BLER: overview.

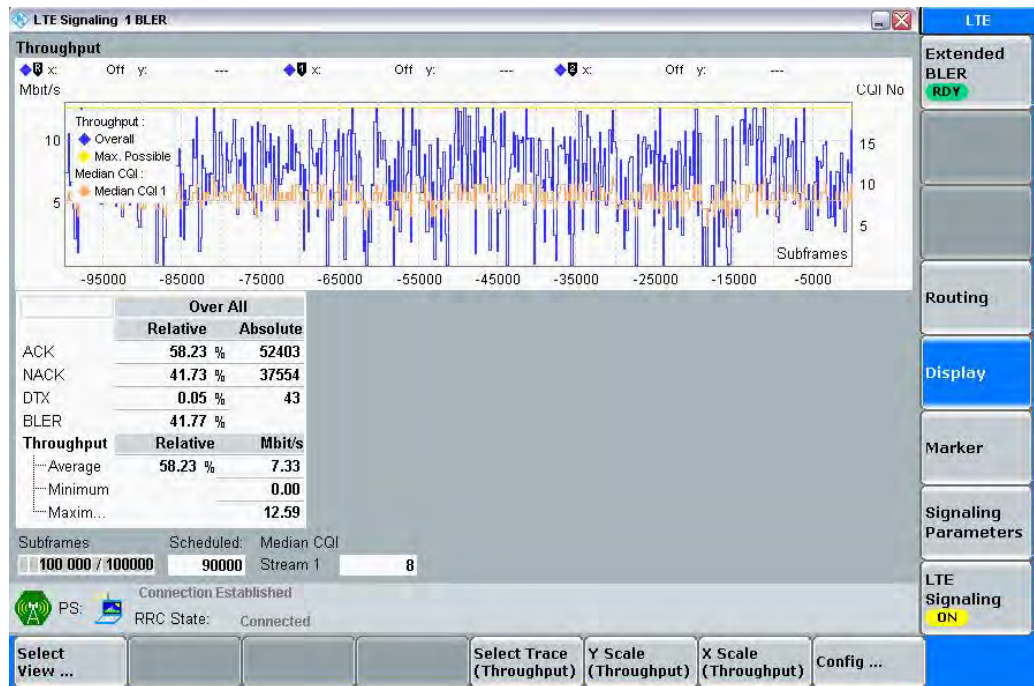

Fig. 3-2: LTE Extended BLER: Throughput

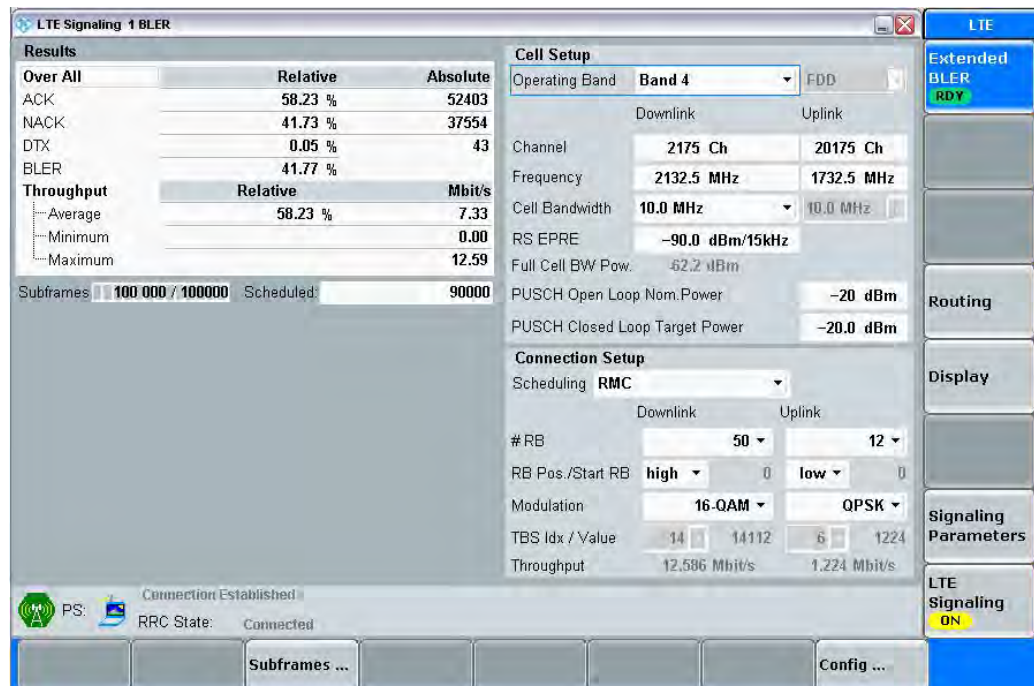

Fig. 3-3: LTE Extended BLER: BLER



Fig. 3-4: LTE Extended BLER: CQI Reporting

Remote Command:

```
CONFigure:LTE:SIGN<i>:EBLer:SFRames 10000 // set 10000 frames
INITiate:LTE:SIGN<i>:EBLer // start measurement
FETCh:LTE:SIGN<i>:EBLer:ABSolute? // get results(abs.)
```

### 3.2 Scenarios for one cell

This section covers tests with one downlink carrier only. Different transmission modes require different fading paths. In the CMW these scenarios differ by the number of the used RF outputs.

#### 3.2.1 “1 Cell – Fading – 1 RF Out” scenario (SISO)

This configuration uses only one data stream via one antenna. It covers tests for:

- TM1 SISO
- TM7 Single layer beamforming (port 5)

For this, it is necessary to fade one path only, and that can be done with one of the SMW channels.

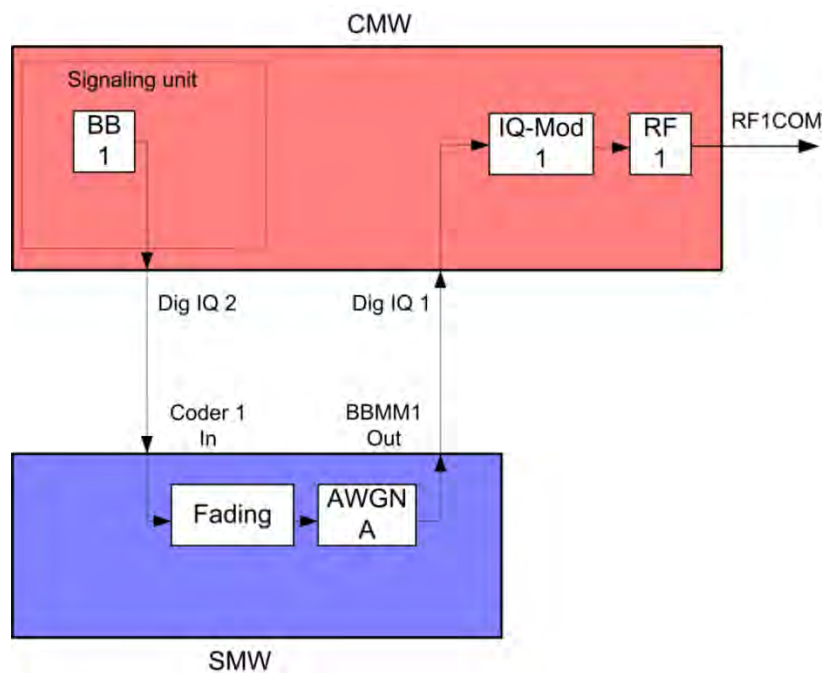

Fig. 3-5: Block diagram for the SISO test setup.

- In the **LTE Signaling Configuration**, select the *1 Cell – Fading – 1 RF out Scenario* (see Fig. 3-6). Set the **Fading** to *External*.

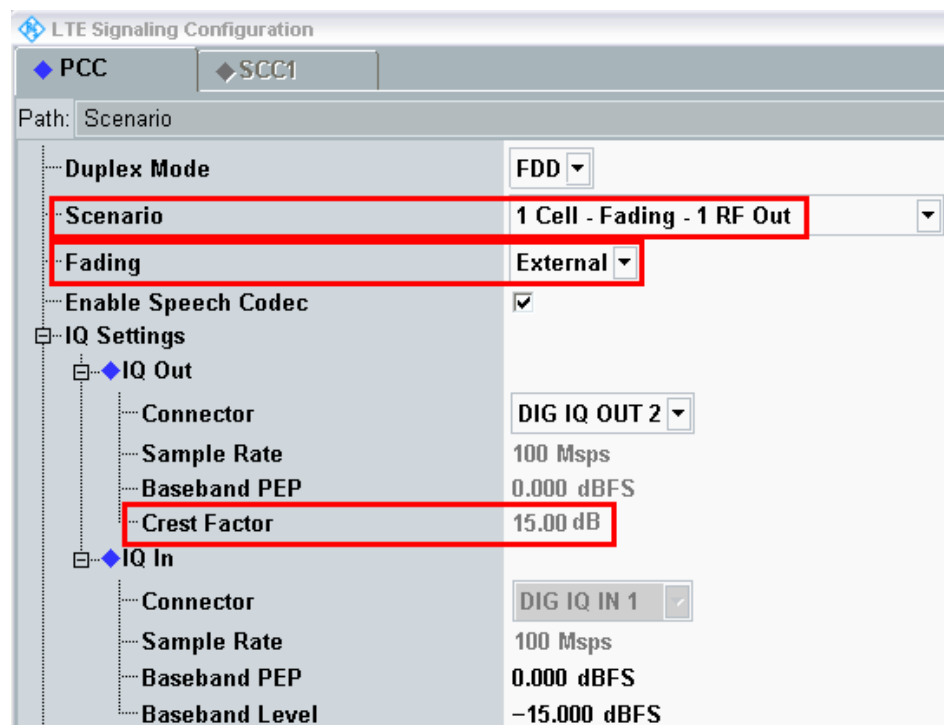

Fig. 3-6: LTE scenario for SISO: Standard Cell Fading. The CMW indicates the crest factor, which is entered in the SMW's Dig IQ Input.

Remote commands:

```
// 1 Cell-Fading- 1 RF Out external via RF2COM and IQ2 Out
ROUTE:LTE:SIGN:SCENario:SCFading RF2C,RX1,RF2C, TX1, IQ2O
// read out information of IQ settings
SENSe:LTE:SIGN<i>:IQOut:PATH<n>?
```

6. Take note of the **Crest Factor** under **IQ Out** and enter this value in the SMW under **Baseband Input Level** (see Fig. 2-13 in section 2.3).
7. Set a fading and switch on **I/Q Out** (BBMM1)(see section 2.3).
8. In the CMW, enter the corresponding baseband level (Level  $BB_{out\ SMW} = Crest\ Factor_{In\ SMW} - Insertion\ Loss$ ; example:  $-15\ dB - 10\ dB = -25\ dBFS$ , see 2.3.8), which is indicated by the SMW (see Fig. 3-9). If you add noise to the signal, note the crest factor without noise.
9. Select a **TM** and a **DCI format** (see also Table 3-2)

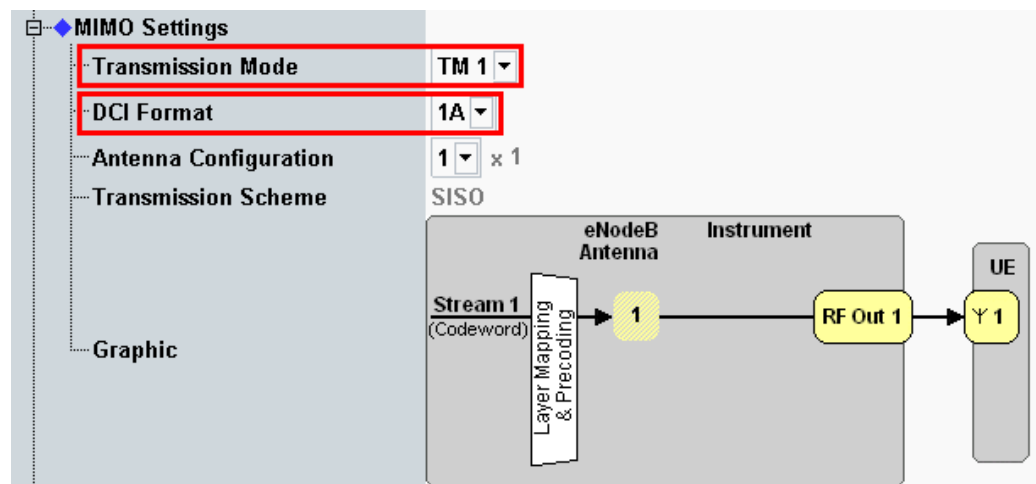

Fig. 3-7: Transmission mode and DCI format. The CMW also shows the transmission scheme and a graphical representation.

Remote commands:

```
// set TM1
CONFigure:LTE:SIGN<i>:CONNection:TRANsmission TM1
// set DCI format 1A
CONFigure:LTE:SIGN<i>:CONNection:DCIFormat D1A
```

10. Use **CONNECT** to establish an LTE connection between the CMW and DUT.
11. If you modify the fading, remember to change the level accordingly in the CMW.

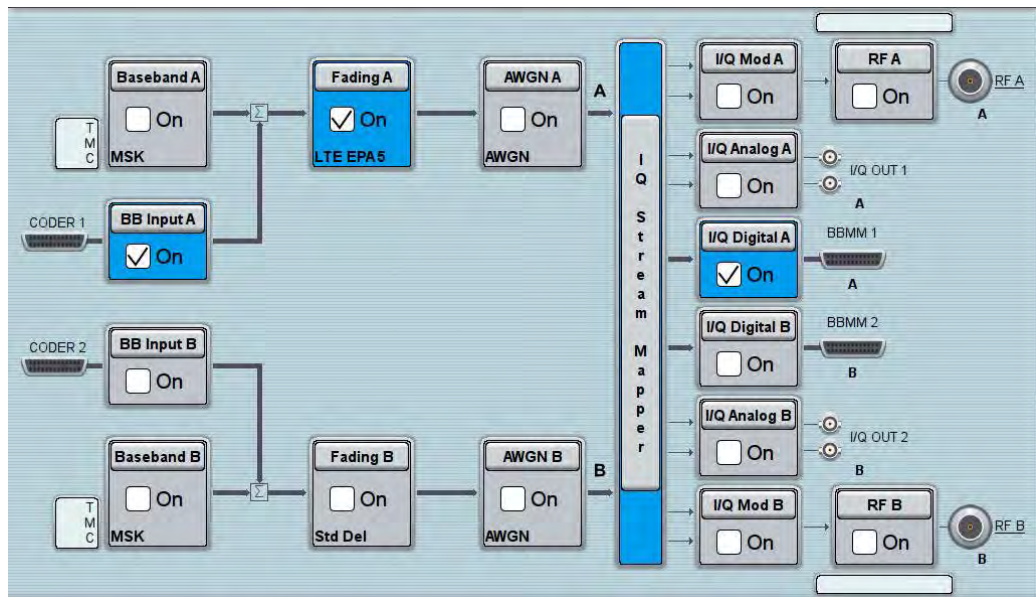

Fig. 3-8: Overview SMW settings for SISO fading.

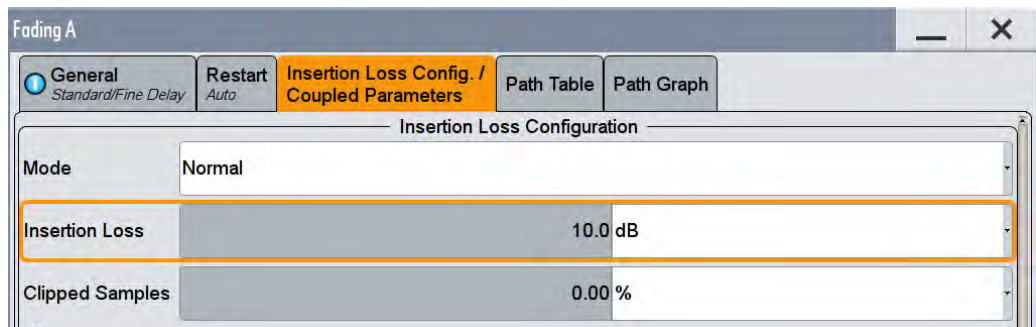

Fig. 3-9: The SMW shows the necessary insertion loss (example: 10 dB)



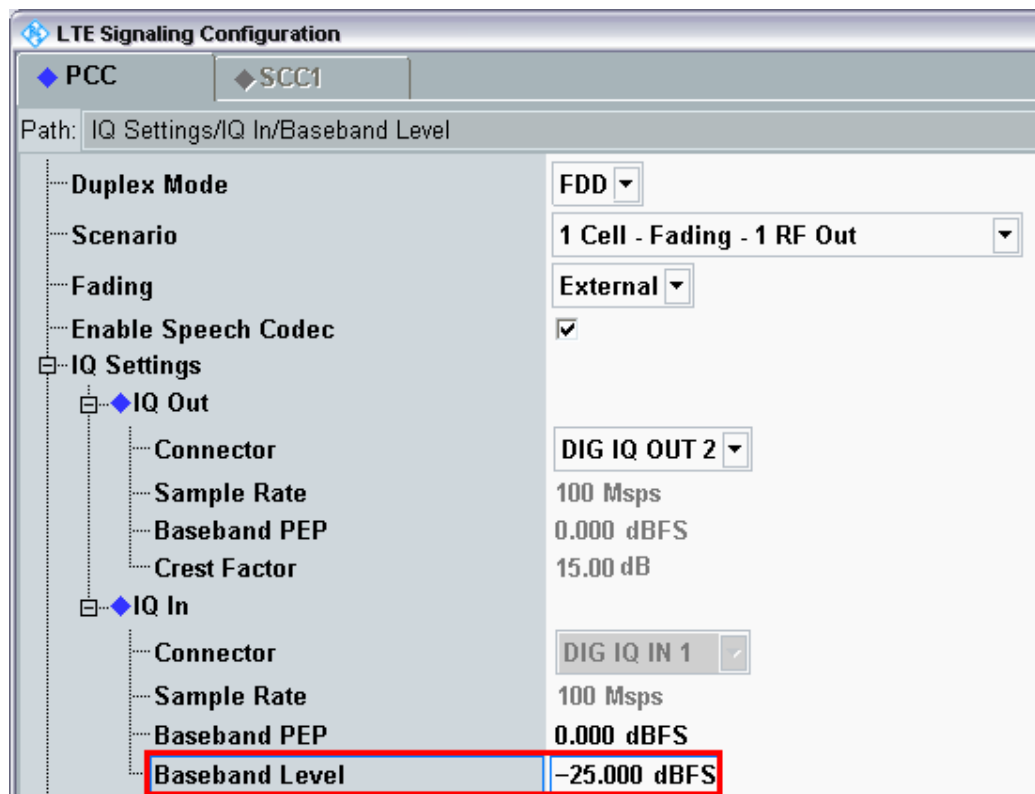

Fig. 3-10: Making allowance for the necessary attenuation in the CMW. Here, the digital output level of the SMW signal is entered as the IQ In level.

Remote command:

```
// set IQ In to PEP 0 dBFS and Level -25 dBFS
CONFigure:LTE:SIGN<i>:IQIN:PATH<n> 0.0, -25.0
```

12. Start the RX measurement using **Extended BLER** (see section 3.1). Fig. 3-11 shows an example of an SISO measurement in the overview.

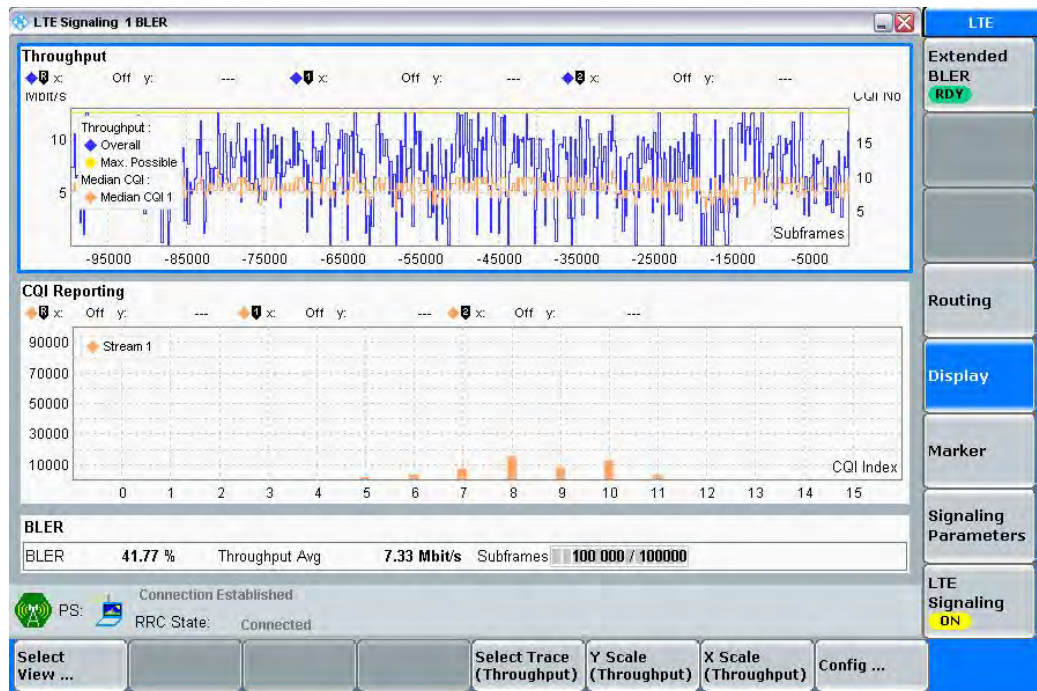

Fig. 3-11: LTE RX measurement for SISO.

### 3.2.2 “1 Cell – Fading – 2 RF Out” scenario (MIMO)

This section covers all scenarios with fading which need two RF output ports. The basic procedure for all the tests is the same, it is shown here once. Specials for single tests follow in the dedicated subsections:

1. In the **LTE Signaling Configuration**, select the *1 Cell – Fading – 2 RF Out Scenario* (see Fig. 3-12). Set **Fading** to *External*.

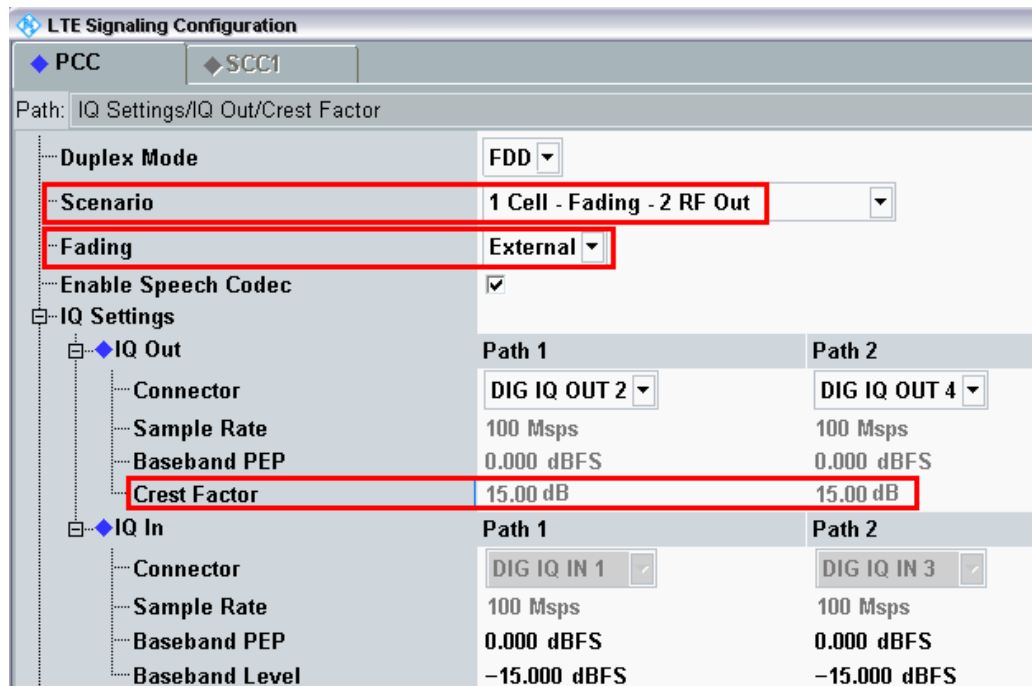

Fig. 3-12: LTE Scenario for two RF out ports: 1 Cell – Fading – 2 RF Out Ports. The CMW indicates the crest factors, which are entered in the SMW's Dig IQ input.

Remote commands:

```
// 1 Cell-Fading-2 RF Out external: RF2C,IQ2Out, RF1C, IQ4Out
ROUTE:LTE:SIGN<i>:SCENario:TROFading
      RF1C,RX1,RF1C, TX1, IQ2O, RF3C, TX2, IQ4O
// read out information of IQ settings
SENSE:LTE:SIGN<i>:IQOut:PATH1?
SENSE:LTE:SIGN<i>:IQOut:PATH2?
```

2. Take note of both **Crest Factors** shown under **IQ Out** and enter the values in the SMW under **Baseband Input Level** (see Fig. 2-13 in section 2.3).
3. Set a fading for both paths and switch on **I/Q Out** (BBMM1|2)(see section 2.3).
4. In the CMW, enter both corresponding baseband levels ( $Level_{out\ SMW} = Crest\ Factor_{in\ SMW} - Insertion\ Loss$ ; example:  $-15\ dB - 10\ dB = -25\ dBFS$ , see 2.3.8), which are indicated by the SMW (see Fig. 3-14). If you add noise to the signal, note the crest factor without noise.
5. Select a **TM** and a **DCI format** (see also Table 3-2). The special settings are handled in the next subsections.
6. Use **CONNECT** to establish an LTE connection between the CMW and DUT.
7. If you modify the fading, remember to change the level accordingly in the CMW.

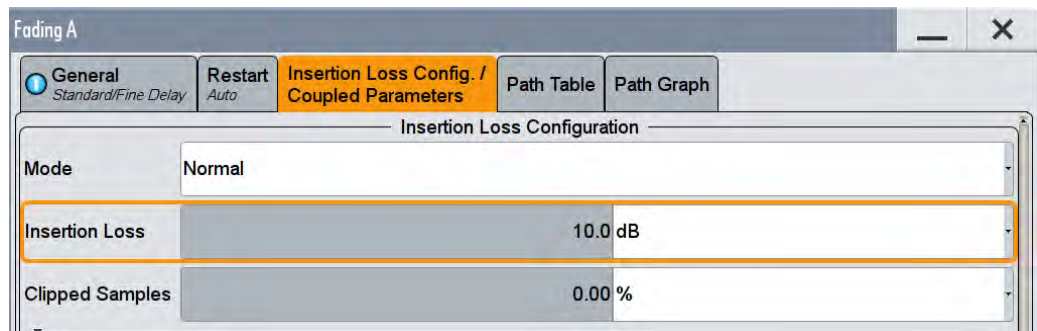

Fig. 3-13: The SMW shows the necessary insertion loss (example: 10 dB)

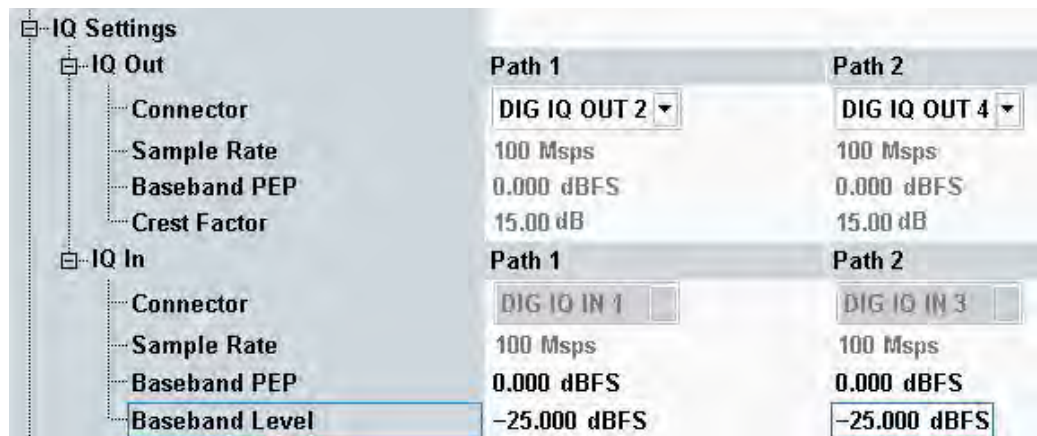

Fig. 3-14: Compensating for the necessary attenuation in the CMW. Here, the levels of the SMW signals are entered as the IQ IN levels.

Remote commands:

```
// set IQ In to PEP 0 dBFS and Level -25 dBFS
CONFigure:LTE:SIGN<i>:IQIN:PATH1 0.0, -25.0
CONFigure:LTE:SIGN<i>:IQIN:PATH2 0.0, -25.0
```

8. Start the RX measurement using **Extended BLER** (see section 3.1)

### 3.2.2.1 Rx Diversity (1x2 SIMO) Configuration (TM1)

For Rx diversity, a signal sent from one antenna is received at the UE with two antennas. Consequently, it arrives via two different receive paths. No additional coding is employed on the transmitter side. TM1 is used. Therefore, in order to perform the measurement under fading conditions, it is necessary to simulate two receiving paths.

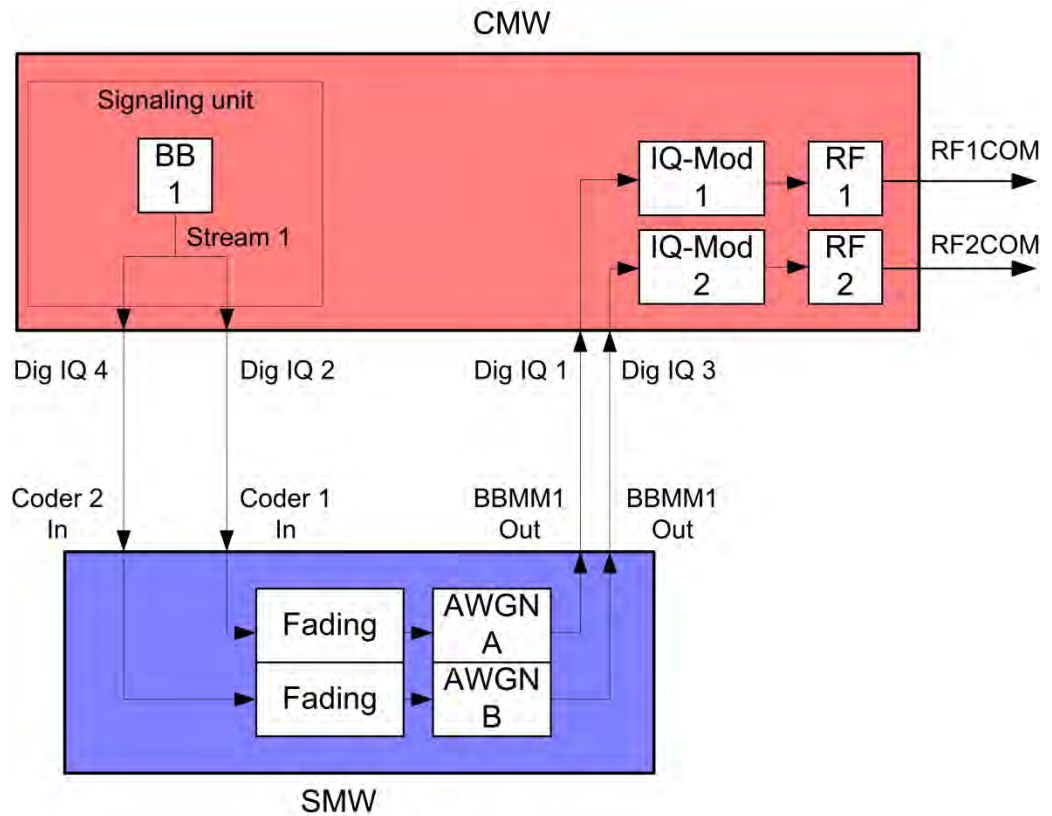

Fig. 3-15: Block diagram for the SIMO test setup. The two receive paths are simulated using the same stream.

1. Select a **TM** and a **DCI format** (see also [Table 3-2](#)). RX Diversity (SIMO 1x2) uses **TM1** and **DCI Format 1A**.

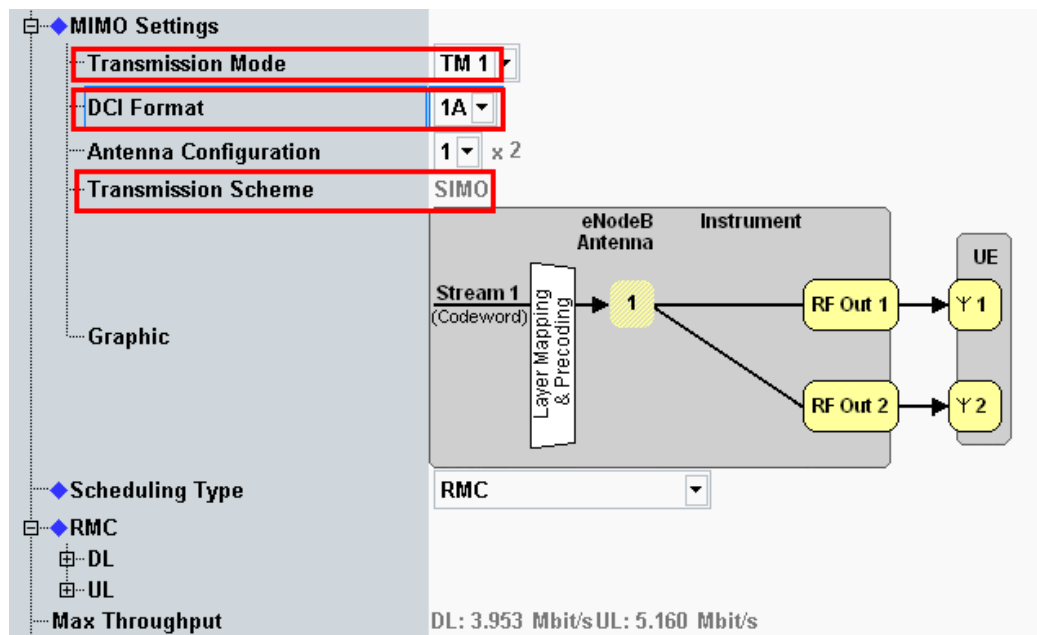

Fig. 3-16: Transmission mode and DCI format. The CMW also shows the transmission scheme and a graphical representation.

Remote commands:

```
// set TM1
CONFIGure:LTE:SIGN<i>:CONNECTION:TRANsmission TM1
// set DCI format 1A
CONFIGure:LTE:SIGN<i>:CONNECTION:DCIFormat D1A
```

2. Use **CONNECT** to establish an LTE connection between the CMW and DUT.
3. If you modify the fading, remember to change the level accordingly in the CMW.

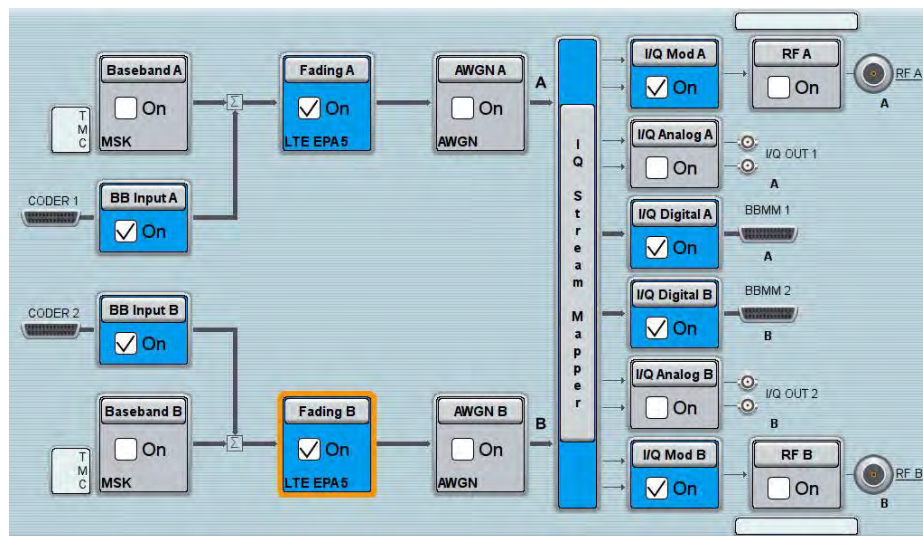

Fig. 3-17: SMW settings for fading two paths (SIMO and MISO).

4. Start the RX measurement using **Extended BLER** (see section 3.1). Fig. 3-11 shows an example of an SIMO measurement in the overview.

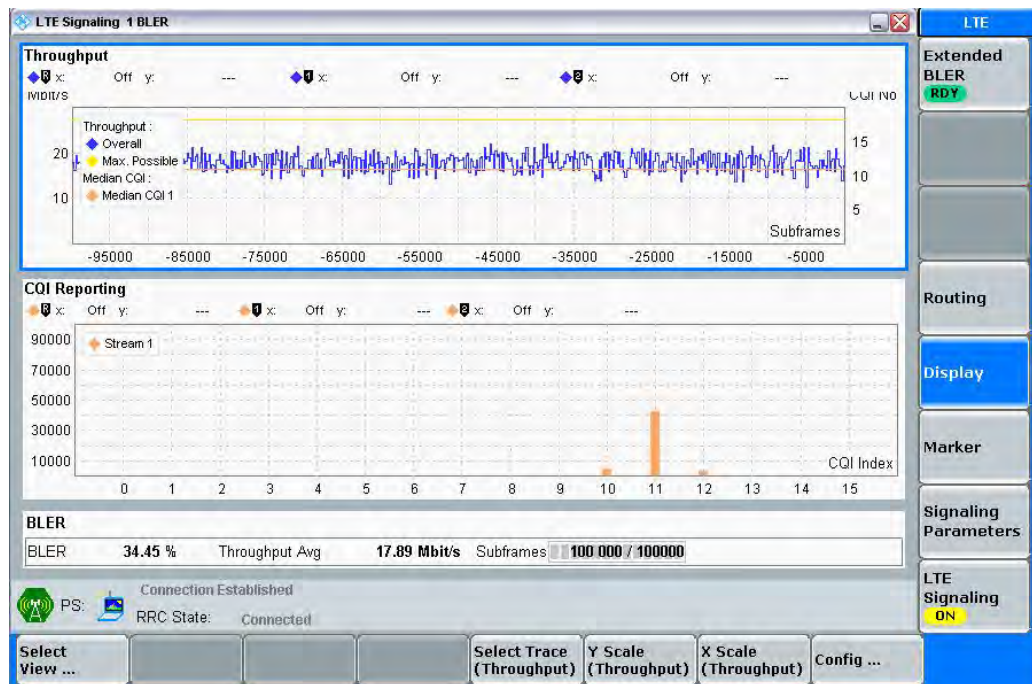

Fig. 3-18: LTE RX measurement for Rx Diversity (SIMO).

### 3.2.2.2 Tx Diversity (2x1 MISO) Configuration (TM2 or TM3)

To conduct the Tx diversity measurement, one signal is transmitted via two antennas using different coding in order to achieve greater robustness. Here, too, there are two different receive paths. Consequently, to take this measurement under fading conditions, it is necessary to simulate two different receive paths. Tx Diversity is a fall back mode in a couple of TM's. The CMW uses TM2 or TM3.

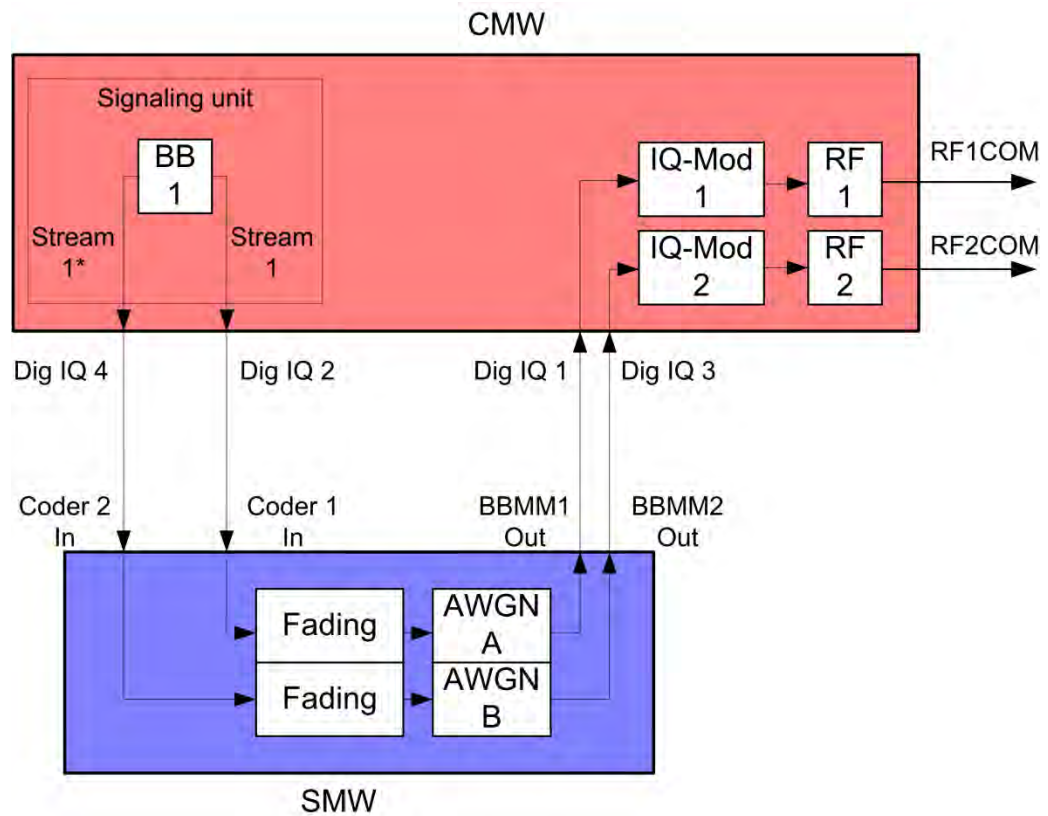

Fig. 3-19: Block diagram for the MISO test setup. Using different coding, one stream is transmitted via two antennas. Consequently, it is necessary to simulate two receive paths.

5. Select a **TM** and a **DCI format** (see also [Table 3-2](#)). Tx Diversity (MISO 2x1) uses **TM2** or **TM3** and **DCI Format 1A**.

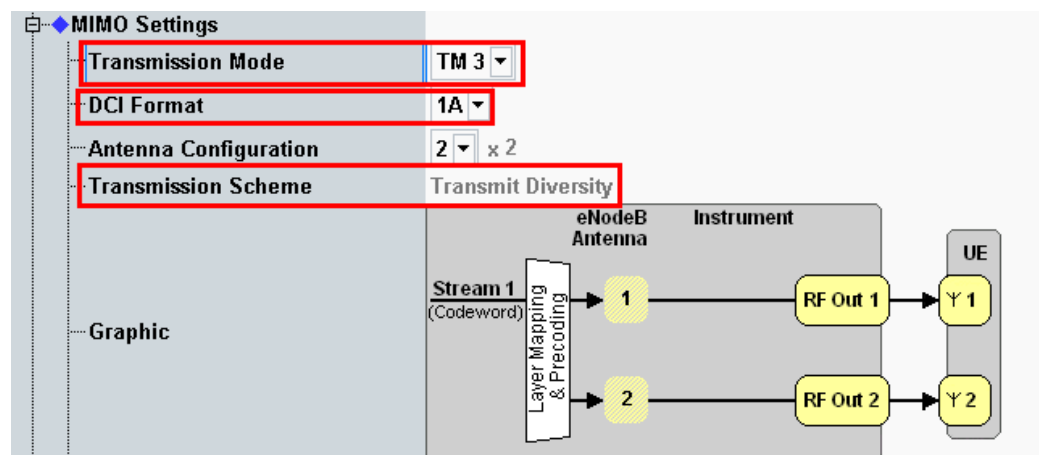

Fig. 3-20: Transmission mode and DCI format. The CMW also shows the transmission scheme and a graphical representation.



Remote commands:

```
// set TM3
CONFigure:LTE:SIGN<i>:CONNectioN:TRANsmission TM3
// set DCI format 1A
CONFigure:LTE:SIGN<i>:CONNectioN:DCIFormat D1A
```

6. Use **CONNECT** to establish an LTE connection between the CMW and DUT.
7. If you modify the fading, remember to change the level accordingly in the CMW.

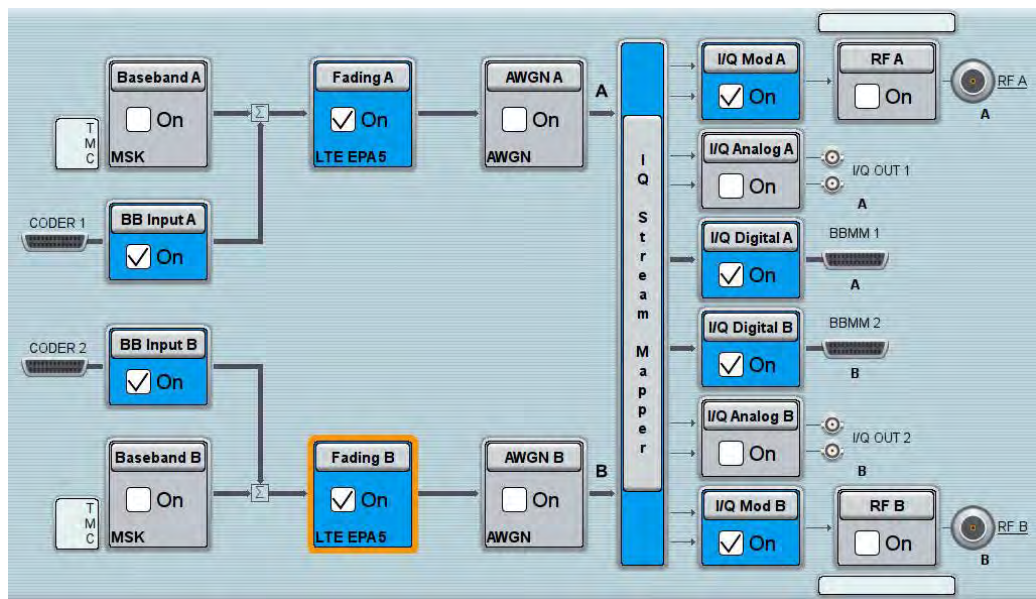

Fig. 3-21: SMW settings for fading two paths (SIMO and MISO).

8. Use **Extended BLER** to start the RX measurement (see section 3.1). Fig. 3-22 shows an example of an MISO measurement in the overview.



Fig. 3-22: LTE RX measurement for Tx diversity (MISO).

### 3.2.2.3 Spatial Multiplexing (2x2 MIMO) Configuration (TM3, TM4, TM6)

With spatial multiplexing, typically two different streams are transmitted via two antennas in order to boost the data throughput rate. For the simulation, it is also necessary to take the cross components into account; consequently, it is necessary to simulate a total of four receive paths.

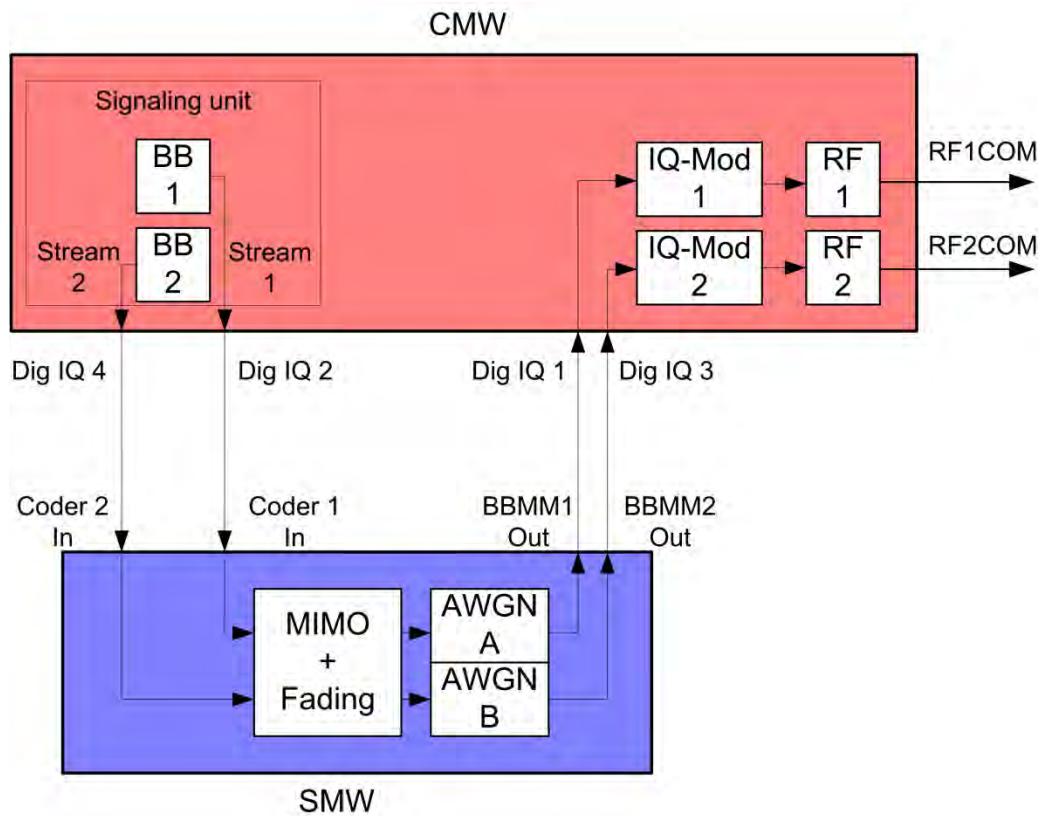

Fig. 3-23: Block diagram for the MIMO test setup. Two streams are transmitted via two antennas. Consequently, in order to also take the cross components into account, it is necessary to simulate four fading paths.

### Open Loop Spatial Multiplexing with CCD (TM3)

- Select **TM3** and **DCI format 2A** (see also [Table 3-2](#)).

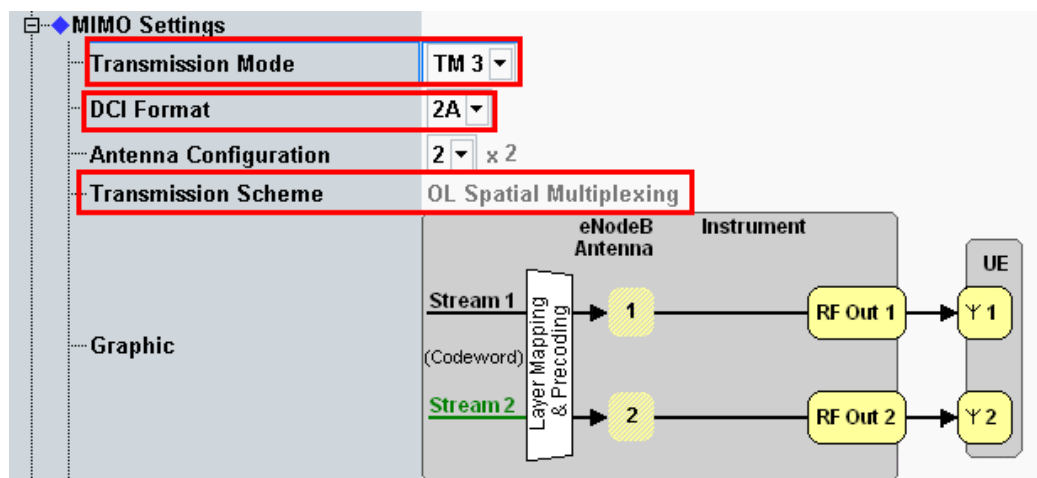

Fig. 3-24: Transmission mode and DCI format for OL spatial multiplexing. The CMW also shows the transmission scheme and a graphical representation.

Remote commands:

```
// set TM3
CONFIGure:LTE:SIGN<i>:CONNectio:n:TRANsmis:sion TM3
// set DCI format 1A
CONFIGure:LTE:SIGN<i>:CONNectio:n:DCIFormat D2A
```

**Closed Loop Spatial Multiplexing (TM4)**

5. Select **TM4**, **DCI format 2** and a **Precoding Matrix** (see also [Table 3-2](#)).

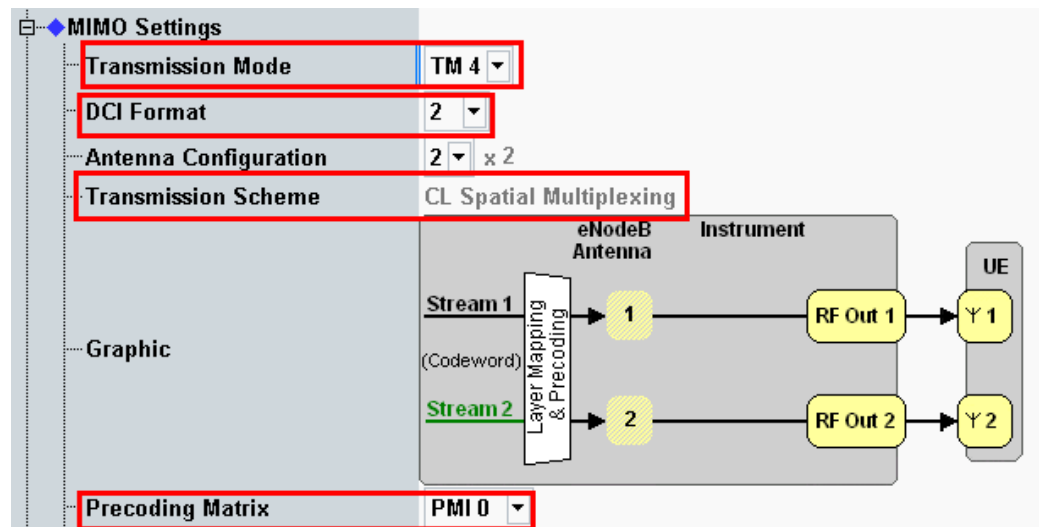

**Fig. 3-25: Transmission mode and DCI format for CL spatial multiplexing. The CMW also shows the transmission scheme and a graphical representation.**

Remote commands:

```
// set TM4
CONFIGure:LTE:SIGN<i>:CONNectio:n:TRANsmis:sion TM4
// set DCI format 2
CONFIGure:LTE:SIGN<i>:CONNectio:n:DCIFormat D2
// set the Precoding Matrix to PMI0
CONFIGure:LTE:SIGN<i>:CONNectio:n:PMATrix PMI0
```

**Closed Loop Spatial Multiplexing, single layer (TM6)**

5. Select **TM6**, **DCI format 1B** and a **Precoding Matrix** (see also [Table 3-2](#)).

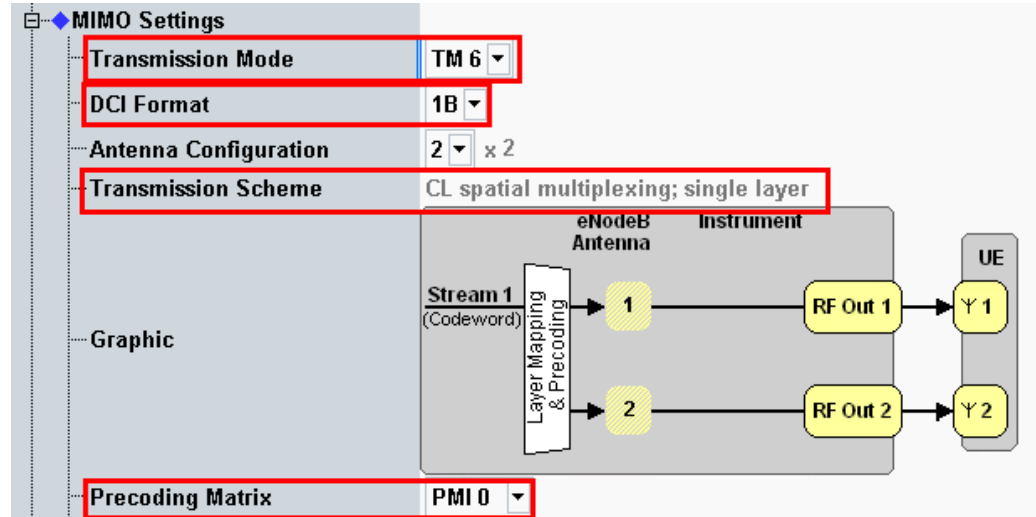

Fig. 3-26: Transmission mode and DCI format for CL spatial multiplexing with a single layer. The CMW also shows the transmission scheme and a graphical representation.

Remote commands:

```
// set TM6
CONFIGure:LTE:SIGN<i>:CONNection:TRANsmission TM6
// set DCI format 1B
CONFIGure:LTE:SIGN<i>:CONNection:DCIFormat D1B
// set the Precoding Matrix to PMI0
CONFIGure:LTE:SIGN<i>:CONNection:PMATrix PMI0
```

6. Use **CONNECT** to establish an LTE connection between the CMW and DUT.
7. If you modify the fading, remember to change the level accordingly in the CMW.

**MIMO Correlation**

There are three correlation modes for EPA, EVA and ETU LTE fading settings in line with 3GPP specification TS36.101.

- Low = No correlation between path A and B faders. This results in the best throughput and BLER results.
- Medium = A and B are correlated to a certain degree, throughput decreases and BLER increases.
- High = Full correlation between A and B faders which annuls the improvement by MIMO.

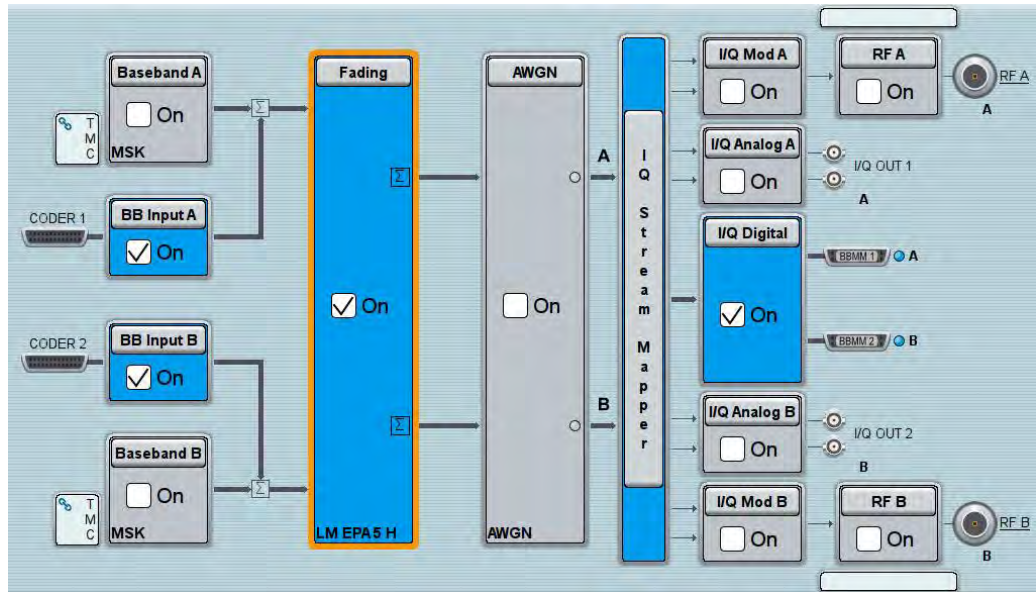

Fig. 3-27: SMW settings for fading four paths (2x2 MIMO).

- Use **Extended BLER** to start the RX measurement (see section 3.1). Fig. 3-28 shows an example of an MIMO measurement in the overview.

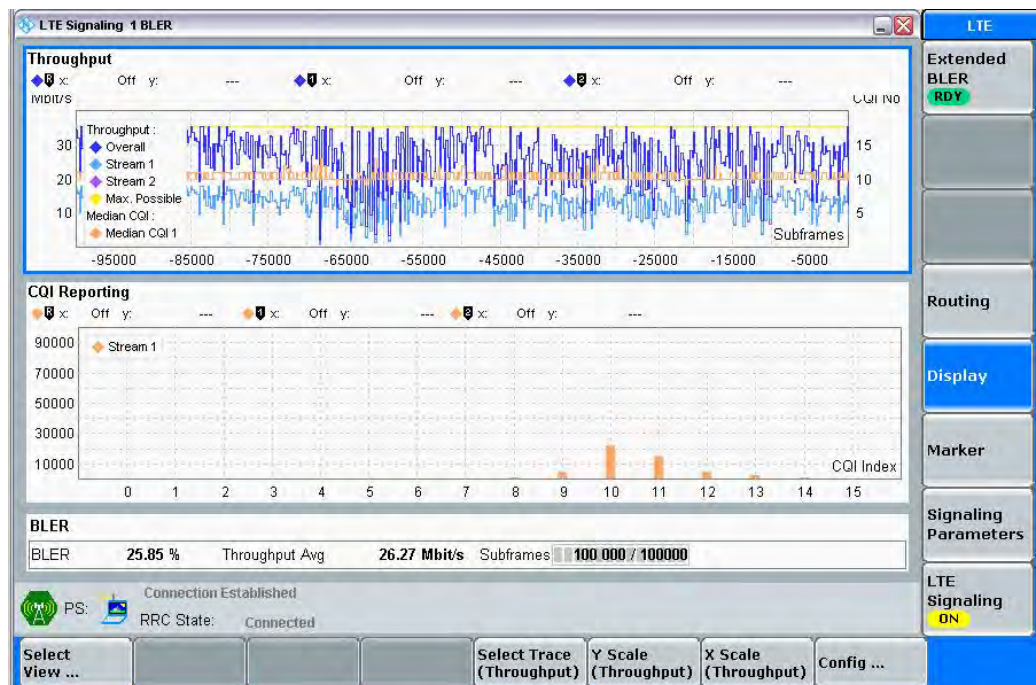

Fig. 3-28: LTE RX measurement for 2x2 MIMO. The measurements are adapted automatically for both streams individually as well as in the form of an overall assessment.

### 3.2.2.4 Beamforming (TM7 und TM 8)

#### Single layer Beamforming TM7

In TM7, the basestation may use an antenna array to transmit the signal. No matter how many antennas are used, the UE “sees” one virtual antenna port (port 5). This is similar to SISO (1x1).

The CMW supports TM7 with one transmit antenna (see 3.2.1), or here with two transmit antennas as an antenna array. Both antennas transmit the same stream, but with a different phase. Thus only two fading paths are necessary.

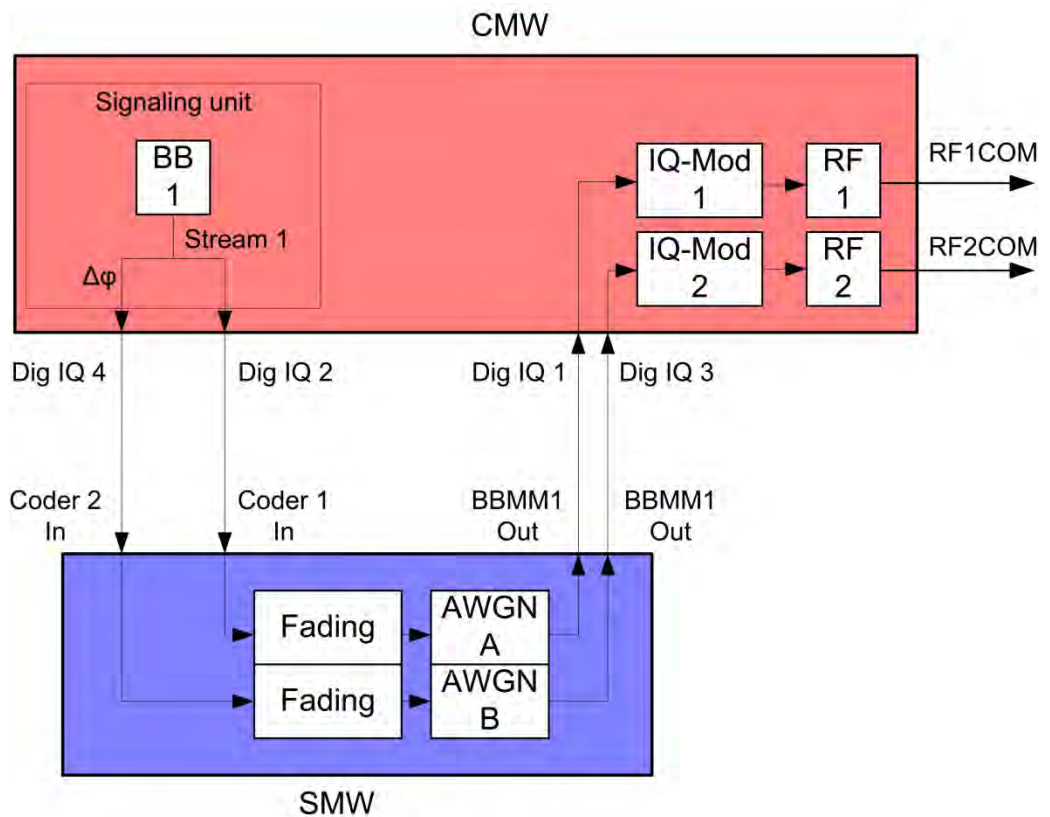

Fig. 3-29: Block diagram for the beamforming test in TM7. One stream is transmitted via two antennas with a different phase. Consequently, it is necessary to simulate two receive paths.

1. Select **TM7** and a **DCI format 1**(see also [Table 3-2](#)). Set the different phases.

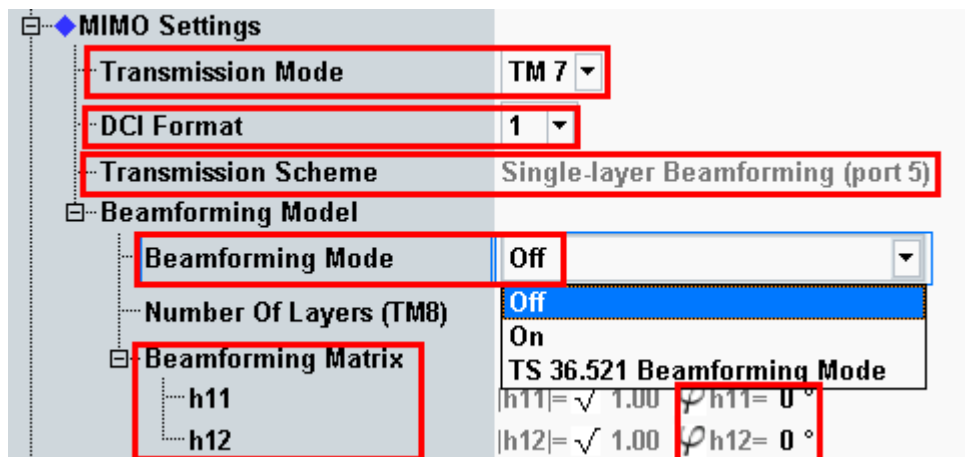

Fig. 3-30: Transmission mode and DCI format. The CMW also shows the transmission scheme and a graphical representation.

Remote commands:

```
// set TM7
CONFIGure:LTE:SIGN<i>:CONNECTION:TRANsmission TM7
// set DCI format 1
CONFIGure:LTE:SIGN<i>:CONNECTION:DCIFormat D1
// set beamforming mode ON
CONFIGure:LTE:SIGN<i>:CONNECTION:BEAMforming:MODE ON
// set beamforming matrix 0°, 30°
CONFIGure:LTE:SIGN<i>:CONNECTION:BEAMforming:MATRix 0,30
```

2. Use **CONNECT** to establish an LTE connection between the CMW and DUT.
3. If you modify the fading, remember to change the level accordingly in the CMW.

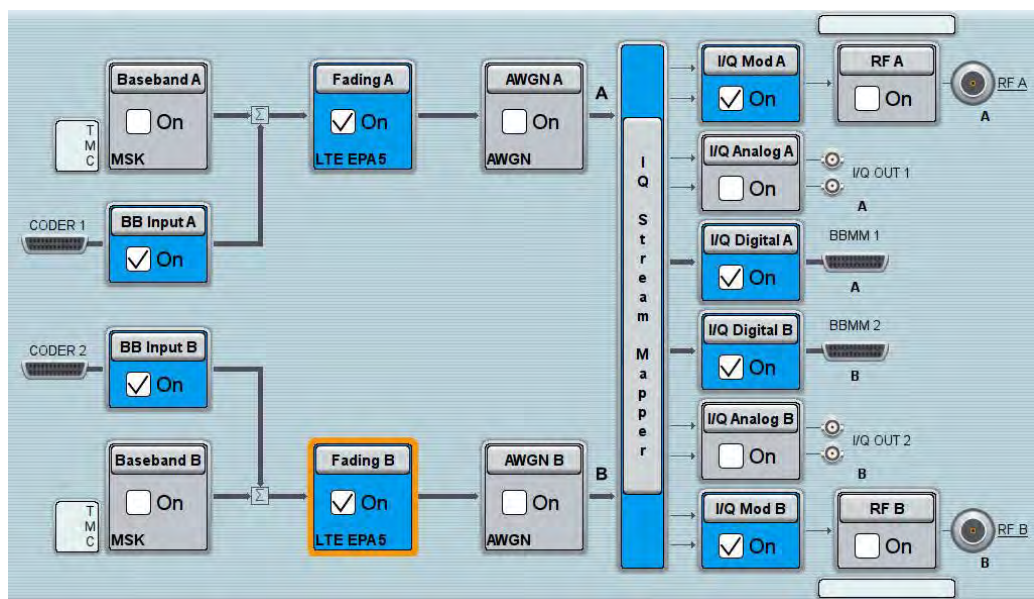

Fig. 3-31: SMW settings for fading two paths.



4. Use **Extended BLER** to start the RX measurement (see section 3.1).

### Dual layer Beamforming TM8

In TM8, the basestation may use an antenna array to transmit the two layer signals. No matter how many antennas are used, the UE “sees” two virtual antenna ports (port 7 and 8; or in single layer mode just one port). This is similar to MIMO (2x2).

The CMW supports TM8 with two transmit antennas. Both antennas transmit different streams, an additional weighting in magnitude and phase can be applied. Thus four fading paths are necessary.

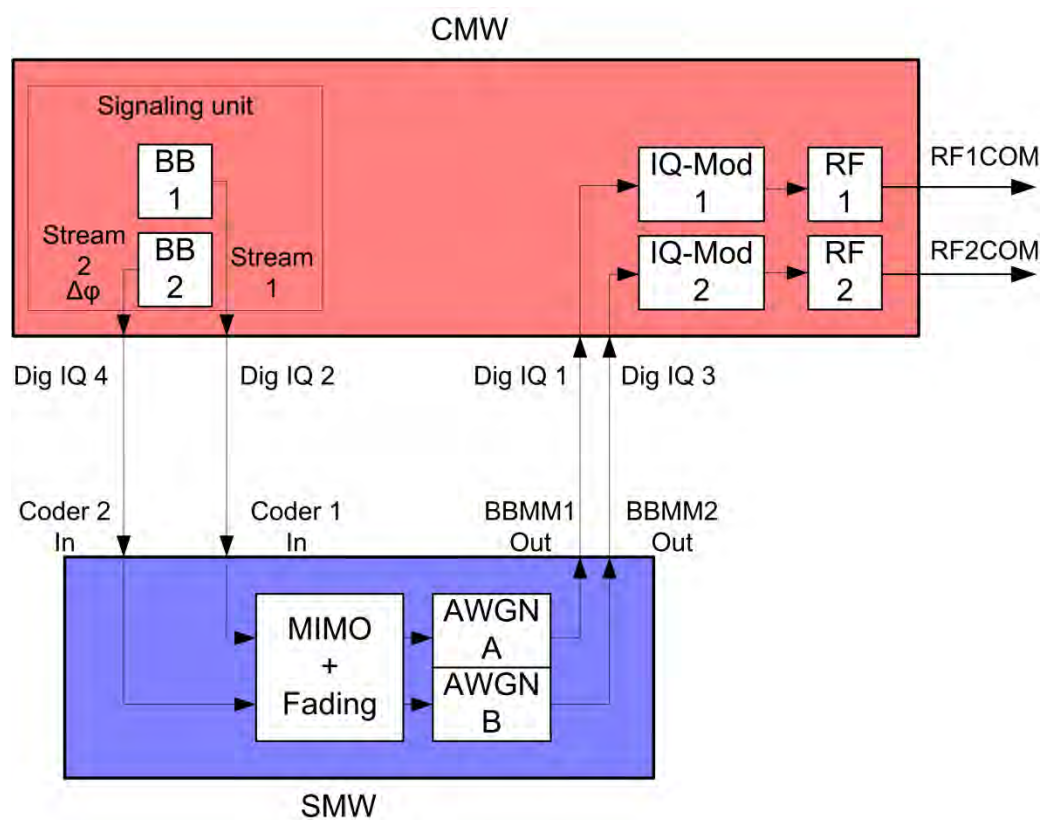

Fig. 3-32: Block diagram for the beamforming test in TM8. Two streams are transmitted via two antennas with a different phase. Consequently, it is necessary to simulate four receive paths.

1. Select **TM8** and a **DCI format 2B** (see also Table 3-2). Set the different weights in the matrix.

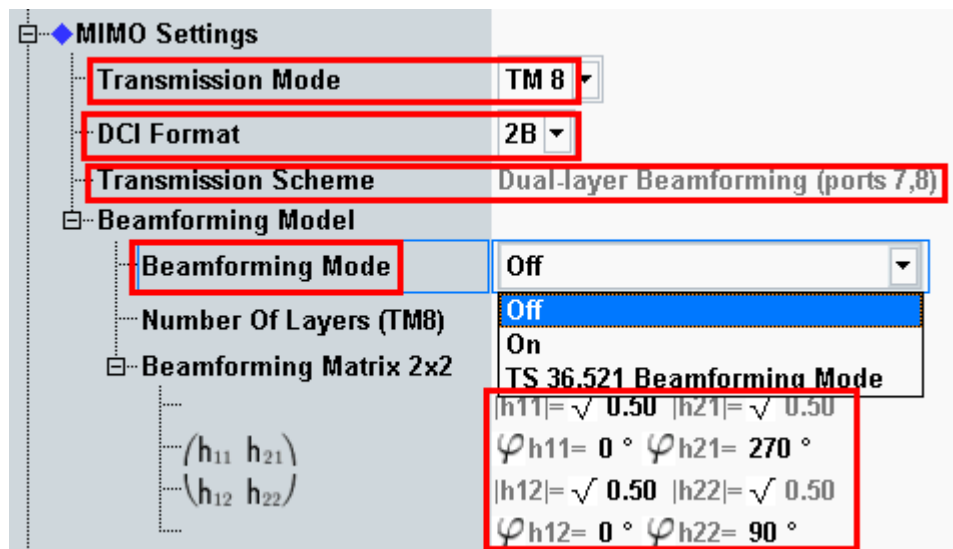

Fig. 3-33: Transmission mode and DCI format. The CMW also shows the transmission scheme and a graphical representation.

#### Remote commands:

```
// set TM8
CONFIGure:LTE:SIGN<i>:CONNECTION:TRANsmission TM8
// set DCI format 2B
CONFIGure:LTE:SIGN<i>:CONNECTION:DCIFormat D2B
// set beamforming mode ON
CONFIGure:LTE:SIGN<i>:CONNECTION:BEAMforming:MODE ON
// set beamforming matrix h11phi,h12phi,h11abs,h12abs,h21phi,h22phi
CONFIGure:LTE:SIGN<i>:CONNECTION:BEAMforming:MATRix
                                0,0,0.5,0.5,270,90
```

2. Use **CONNECT** to establish an LTE connection between the CMW and DUT.
3. If you modify the fading, remember to change the level accordingly in the CMW.

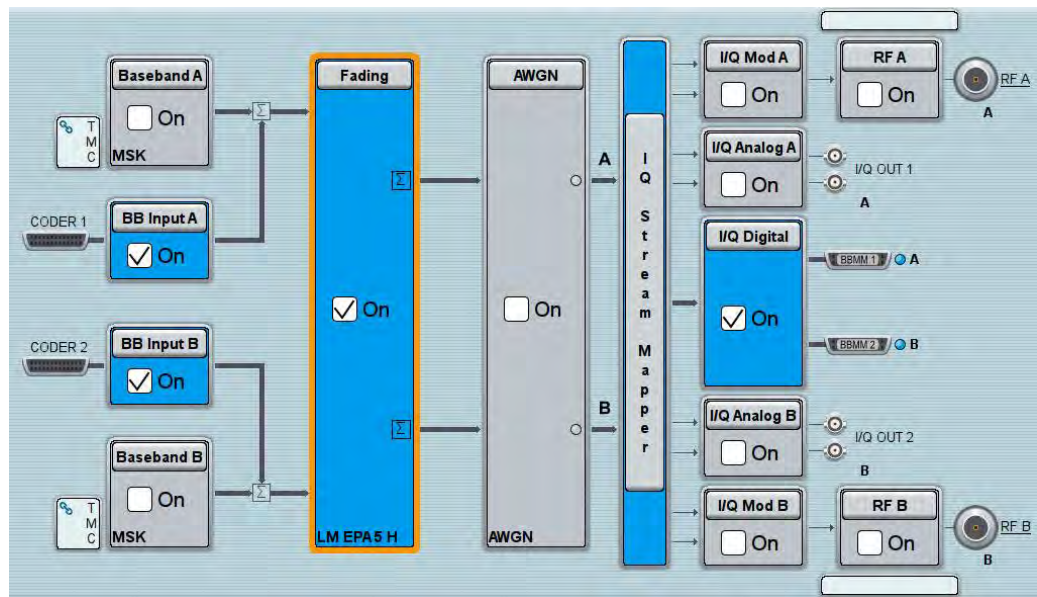

Fig. 3-34: SMW settings for fading four paths (2x2 MIMO).

4. Use **Extended BLER** to start the RX measurement (see section 3.1).

### 3.2.3 “1 Cell – Fading –MIMO 4x2 2 RF Out” scenario (4x2 MIMO)

This section covers all 4x2 MIMO scenarios with fading which need two RF output ports. These are:

- TM2 Tx Diversity
- TM3 Open loop spatial multiplexing
- TM4 closed loop spatial multiplexing
- TM6 closed loop spatial multiplexing, single layer

The setting for the **Antenna Configuration** is always 4x2. Please note that two SMWs are necessary to provide the fading paths. The CMW allows free routing of the two output connectors to meet the DUT’s needs.

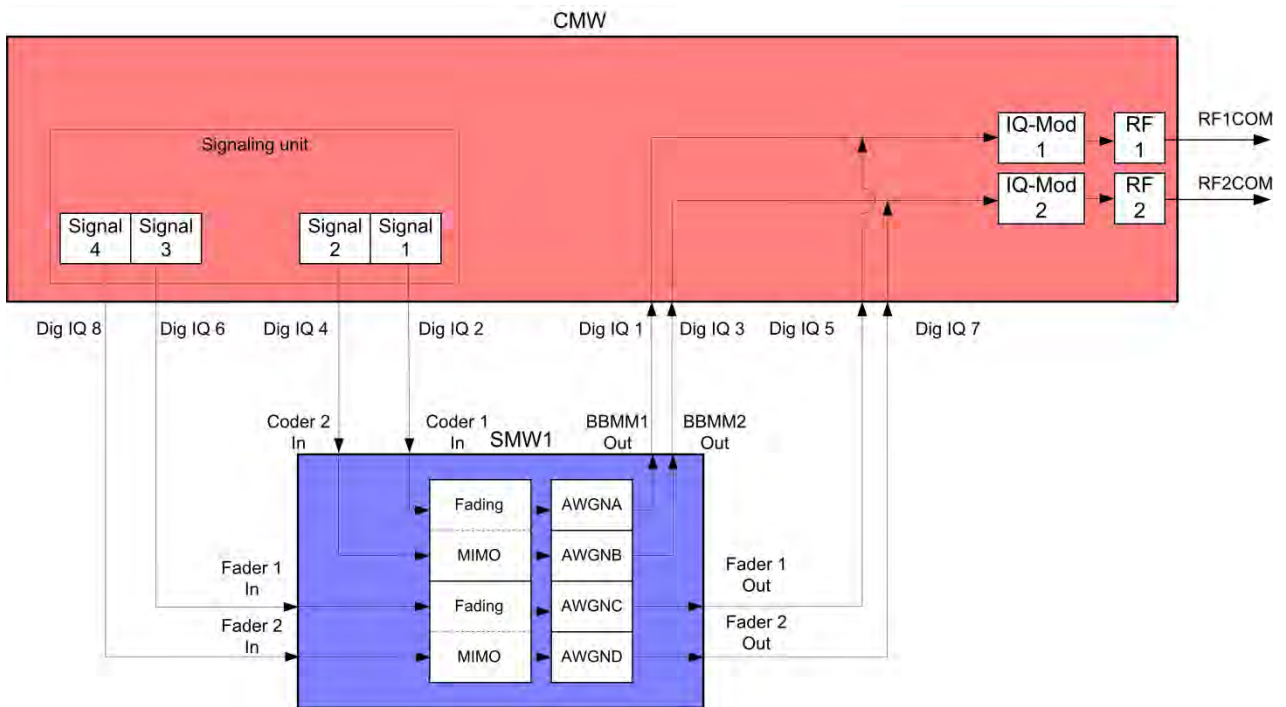

Fig. 3-35: Block diagram for the 4x2 MIMO test setup.

The basic procedure for all the tests is the same, only the MIMO settings differ (TMs):

1. In the **LTE Signaling Configuration**, select the **1 Cell – Fading – MIMO 4x2 – 2 RF Out Scenario** (see Fig. 3-48). Set **Fading** to *External*.

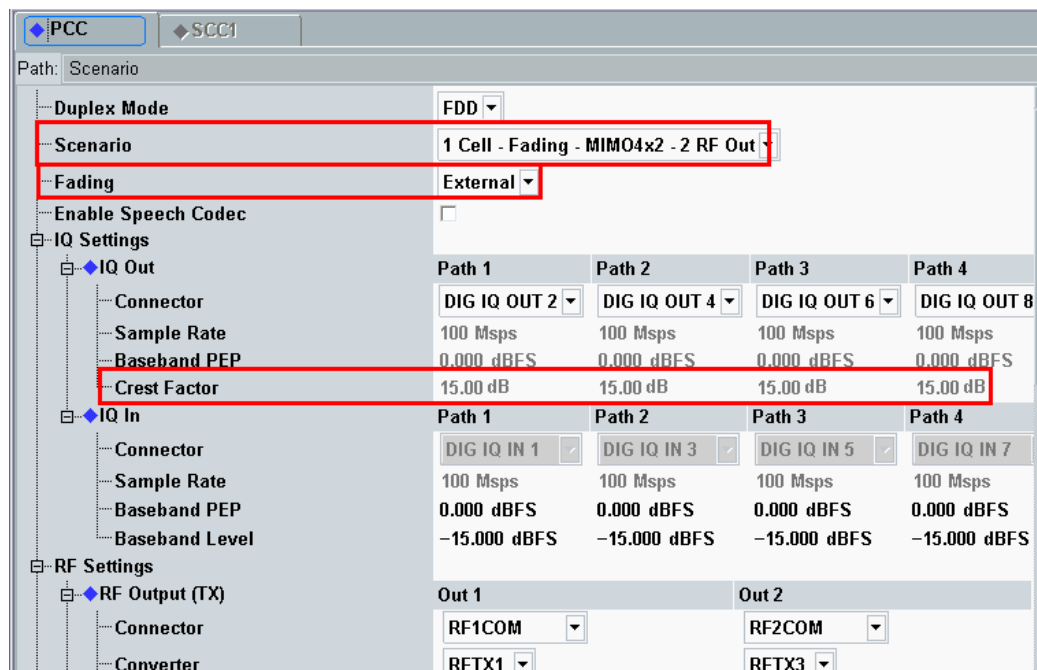

Fig. 3-36: LTE Scenario for 4x2 MIMO and two RF out ports: 1 Cell – Fading – MIMO 4x2 - 2 RF Out Ports. The CMW indicates the crest factors, which are entered in the SMW's Dig IQ input.

Remote commands:

```
// 1 Cell-Fading-MIMO 4x2 - 2 RF Out external:
ROUTE:LTE:SIGN<i>:SCENario:MTF
    RF1C,RX1,RF1C,TX1,IQ20,IQ40,
    RF2C,TX3,IQ60,IQ80

// read out information of IQ settings
SENSe:LTE:SIGN<i>:IQOut:PATH1?
SENSe:LTE:SIGN<i>:IQOut:PATH2?
SENSe:LTE:SIGN<i>:IQOut:PATH1?
SENSe:LTE:SIGN<i>:IQOut:PATH2?
```

2. Take note of the four **Crest Factors** shown under **IQ Out** and enter the values in both SMWs under **Baseband Input Level** (see Fig. 2-13 in section 2.3).
3. Set a MIMO fading for all paths and switch on **I/Q Out** (both SMWs: BBMM1|2)(see section 2.3).
4. In the CMW, enter both corresponding baseband levels (Level BB<sub>out SMW</sub> = Crest Factor<sub>In SMW</sub> – Insertion Loss; example: -15 dB – 10 dB = -25 dBFS, see 2.3.8 ), which are indicated by the SMWs (see Fig. 3-14). If you add noise to the signal, note the crest factor without noise.
5. Select a **TM** and a **DCI format** (see 3.2.2 and also Table 3-2 for details).

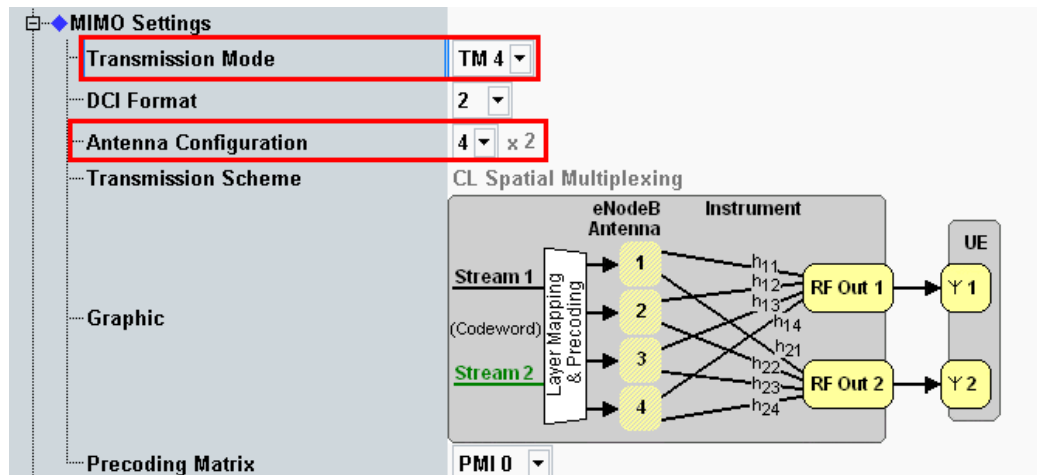

Fig. 3-37: Example for the 4x2 MIMO fading with TM4. The antenna configuration is fixed to 4x2.

6. Use **CONNECT** to establish an LTE connection between the CMW and DUT.
7. If you modify the fading, remember to change the level accordingly in the CMW.

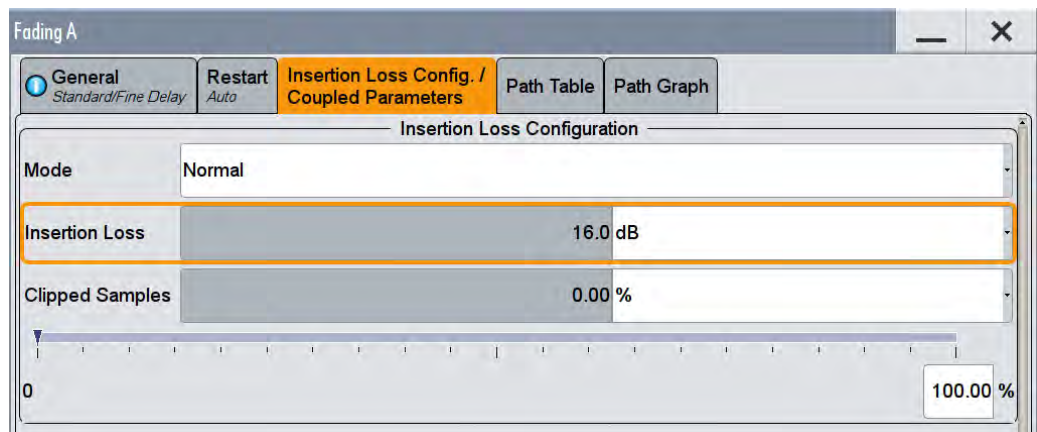

Fig. 3-38: The SMW shows the necessary insertion loss (example: 16 dB)

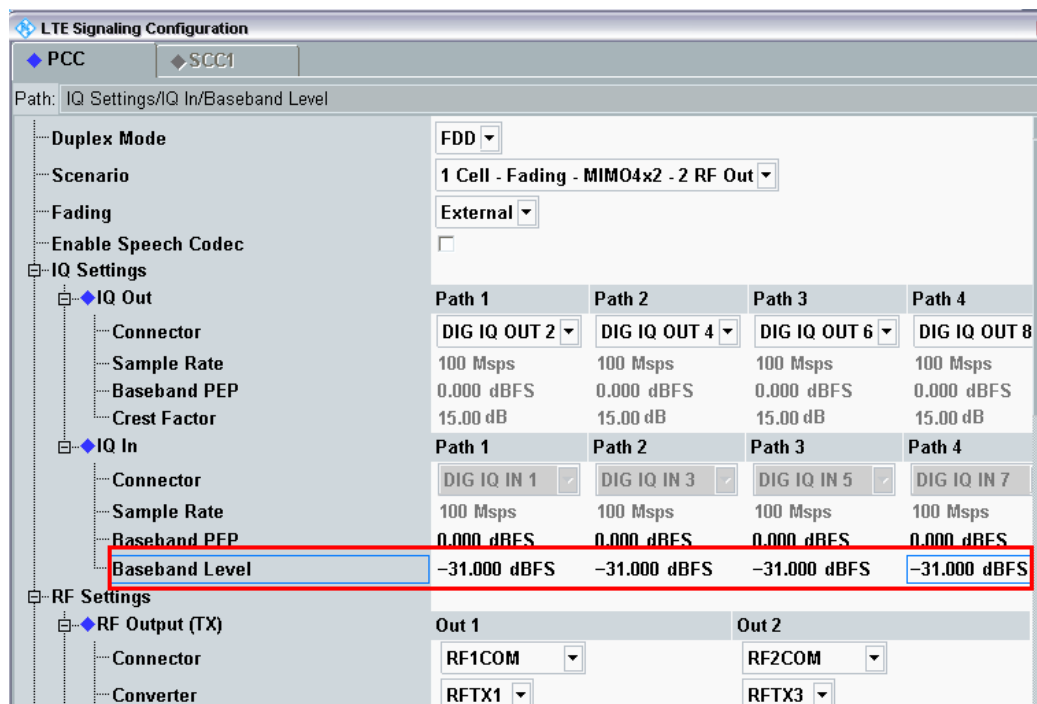

Fig. 3-39: Compensating for the necessary attenuation in the CMW. Here, the levels of the SMWs signals are entered as the IQ IN levels.

Remote commands:

```
// set IQ In to PEP 0 dBFS and Level -31 dBFS
CONFigure:LTE:SIGN<i>:IQIN:PATH1 0.0, -31.0
CONFigure:LTE:SIGN<i>:IQIN:PATH2 0.0, -31.0
CONFigure:LTE:SIGN<i>:IQIN:PATH1 0.0, -31.0
CONFigure:LTE:SIGN<i>:IQIN:PATH2 0.0, -31.0
```

- Start the RX measurement using **Extended BLER** (see section 3.1)

### 3.3 Scenarios for Carrier Aggregation

This section covers tests with carrier aggregation (CA) for two downlink component carriers (CC: Primary CC (PCC) and Secondary CC (SCC1)). Different transmission modes require different fading paths. In the CMW these scenarios differ by the number of the used RF outputs. The CMW supports all possible frequency allocations in CA (intra-band contiguous, intra-band non- contiguous and inter-band). Both CCs can be set up independently of each other.

#### 3.3.1 “2CC CA – Fading – 2 RF Out” scenario (CA with SISO)

This configuration uses only one data stream per CC via one antenna. Thus two RF connectors are needed. It covers tests for:

- TM1 SISO
- TM7 Single layer beamforming (port 5)

For this, it is necessary to fade two paths independently, and that can be done with two SMW channels. The routing of the CCs to the RF connectors of the CMW can be done individually to according needs.

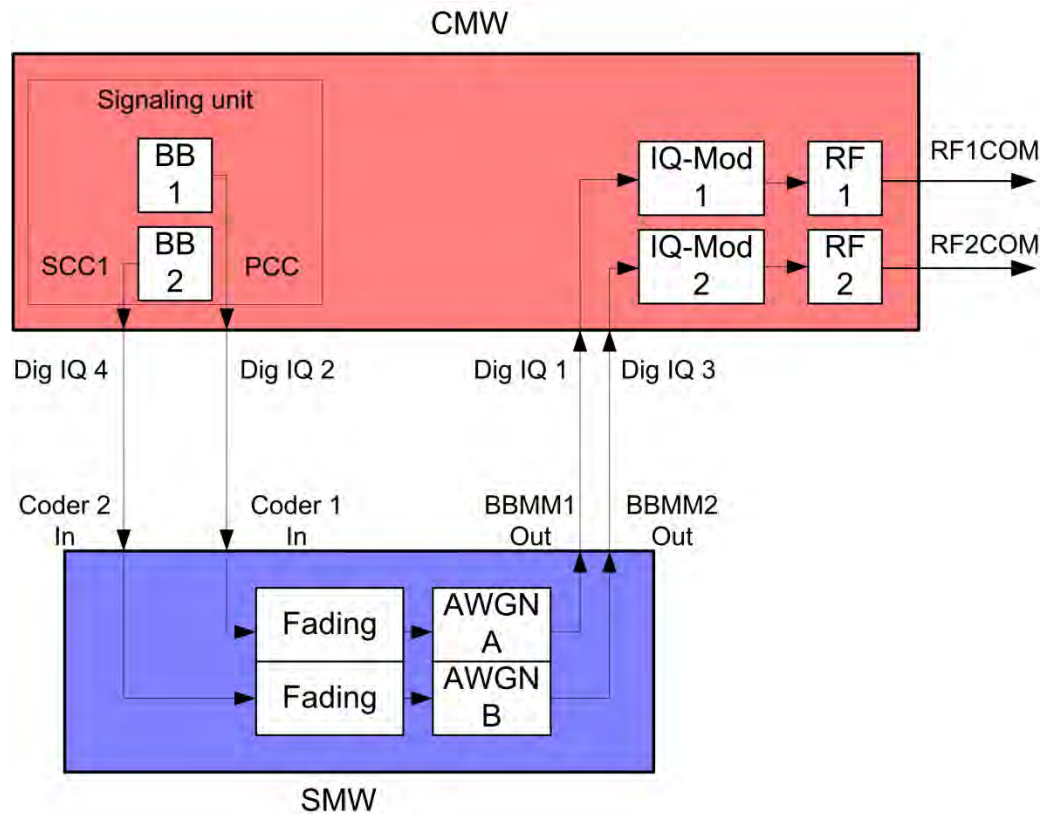

Fig. 3-40: Block diagram for the Carrier Aggregation SISO test setup.

1. In the **LTE Signaling Configuration**, select the **2CC CA– Fading – 2 RF out Scenario** (see Fig. 3-6). Set the **Fading** to *External*.



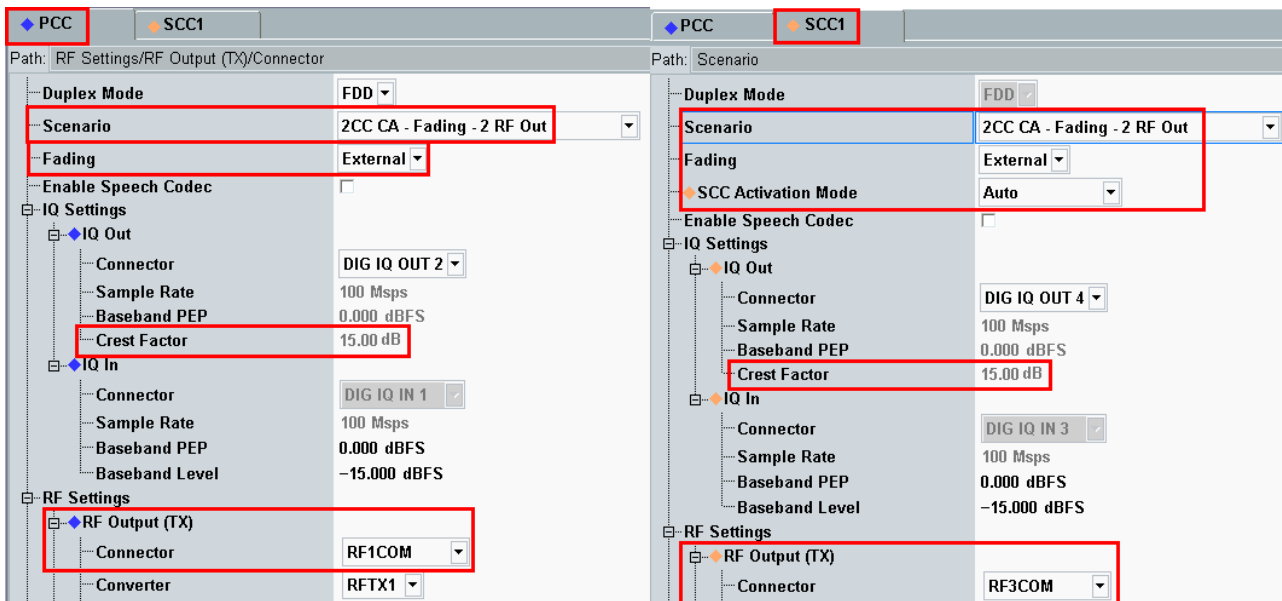

Fig. 3-41: LTE scenario for Carrier Aggregation SISO: 2CC CA Fading. The CMW indicates the crest factors for both component carriers, which are entered in the SMW's Dig IQ Inputs.

Remote commands:

```
// 2CC CA-Fading- 2 RF Out external via RF1COM, IQ2 Out and
// RF3COM, IQ4 Out
ROUTE:LTE:SIGN:SCENario:CATF
      RF1C,RX1,RF1C,TX1,IQ2O,RF3C,TX2,IQ4O
// read out information of IQ settings
SENSE:LTE:SIGN<i>:IQOut[:PCC]:PATH<n>?
SENSE:LTE:SIGN<i>:IQOut:SCC:PATH<n>?
```

2. Take note of the **Crest Factors** under **IQ Out** and enter the values in the SMW under **Baseband Input Level** (see Fig. 2-13 in section 2.3).
3. Set a fading and switch on both **I/Q Out** (BBMM1/2)(see section 2.3).
4. In the CMW, enter the corresponding baseband levels ( $Level_{out\ SMW} = Crest\ Factor_{in\ SMW} - Insertion\ Loss$ ; example:  $-15\ dB - 10\ dB = -25\ dBFS$ , see 2.3.8 ), which are indicated by the SMW (see Fig. 3-44). If you add noise to the signal, note the crest factors without noise.
5. Select a **TM** and a **DCI format** both for PCC and SCC (see also Table 3-2)

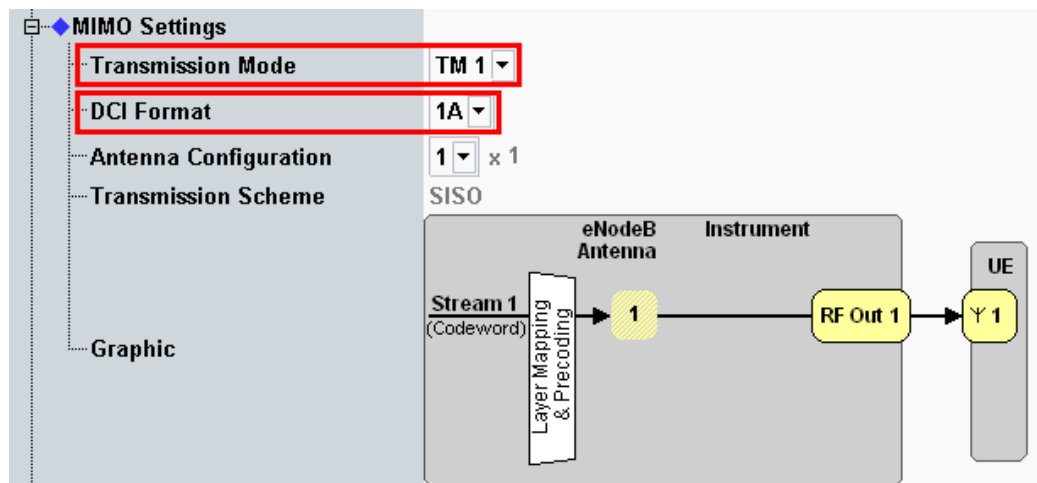

Fig. 3-42: Transmission mode and DCI format. The CMW also shows the transmission scheme and a graphical representation. Set both PCC and SCC.

Remote commands:

```
// set TM1
CONFIGure:LTE:SIGN<i>:CONNECTION[:PCC]:TRANSMISSION TM1
CONFIGure:LTE:SIGN<i>:CONNECTION:SCC:TRANSMISSION TM1

// set DCI format 1A
CONFIGure:LTE:SIGN<i>:CONNECTION[:PCC]:DCIFORMAT D1A
CONFIGure:LTE:SIGN<i>:CONNECTION:DCIFORMAT D1A
```

6. Use **CONNECT** to establish an LTE connection between the CMW and DUT.
7. If you modify the fading, remember to change the level accordingly in the CMW.

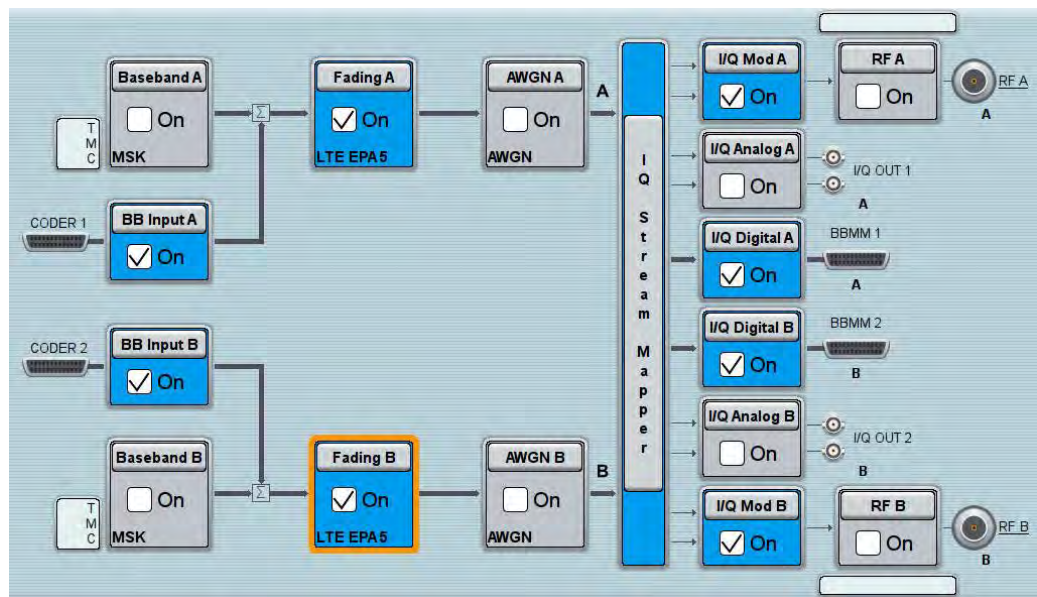

Fig. 3-43: Overview SMW settings for Carrier Aggregation SISO fading.

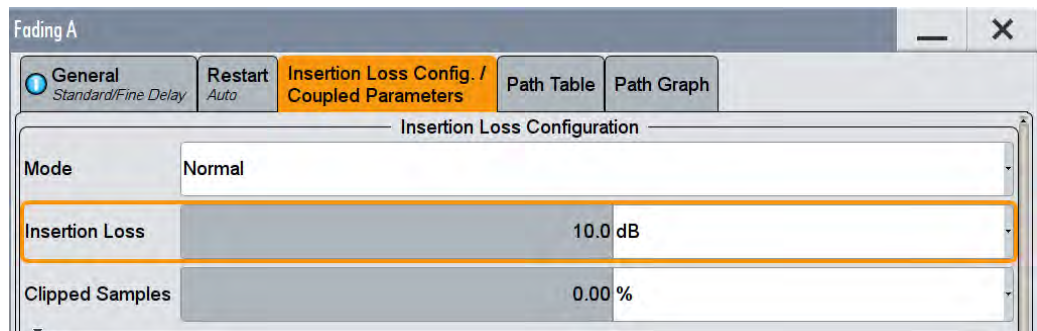

Fig. 3-44: The SMW shows the necessary insertion loss (example: 10 dB)

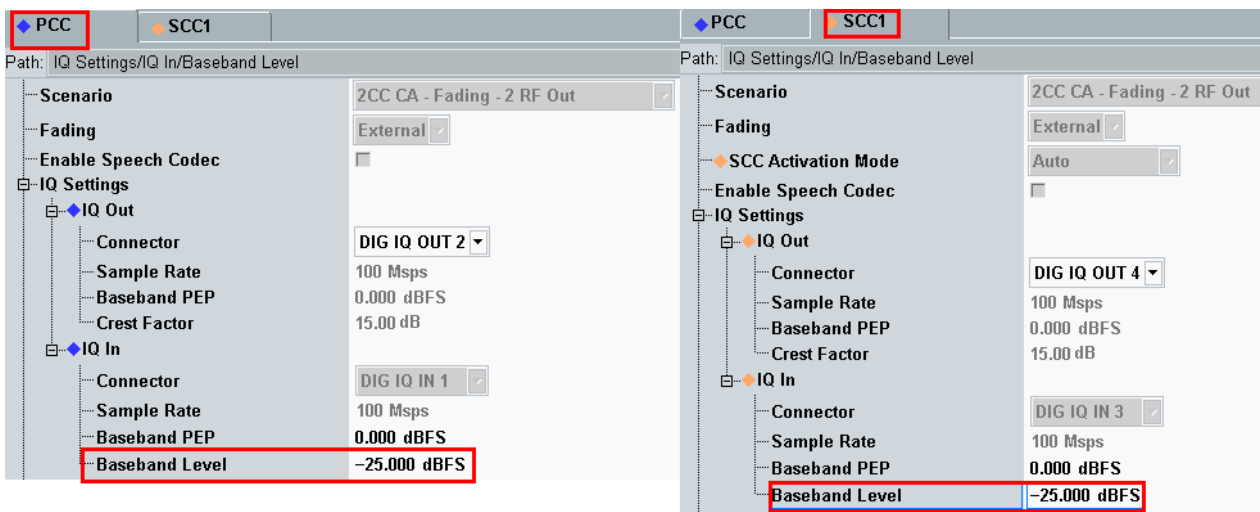

Fig. 3-45: Making allowance for the necessary attenuation in the CMW. Here, the digital output level of the SMW signal is entered as the IQ In level.

Remote command:

```
// set IQ In to PEP 0 dBFS and Level -25 dBFS
CONFigure:LTE:SIGN<i>:IQIN[:PCC]:PATH<n> 0.0, -25.0
CONFigure:LTE:SIGN<i>:IQIN:SCC:PATH<n> 0.0, -25.0
```

8. Start the RX measurement using **Extended BLER** (see section 3.1). Fig. 3-46 shows an example of a Carrier Aggregation SISO measurement in the overview.

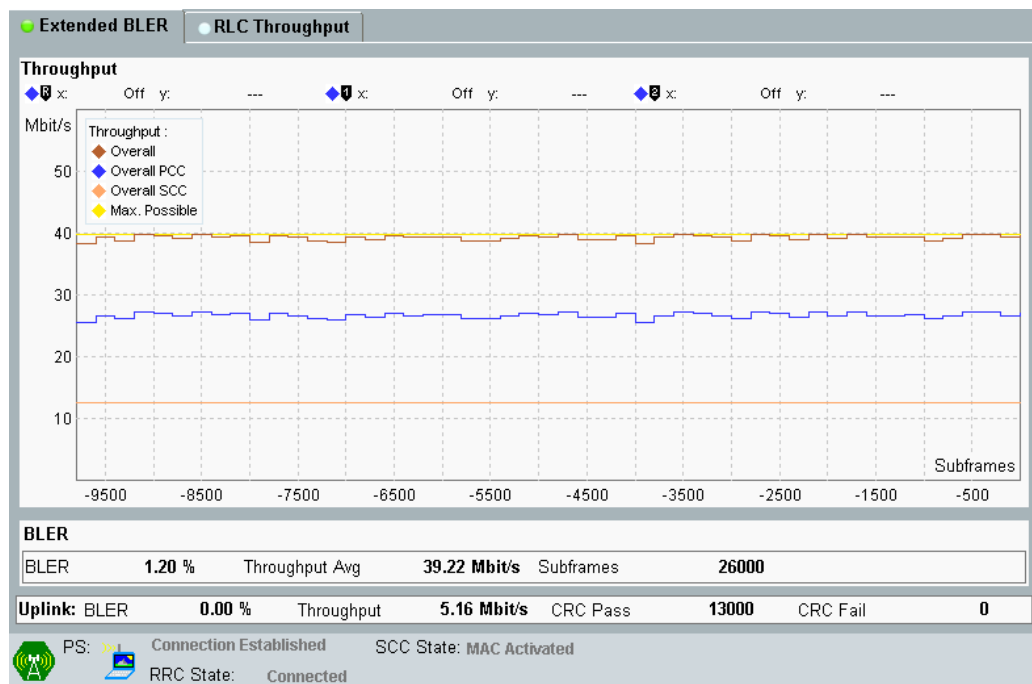

Fig. 3-46: LTE RX measurement for Carrier Aggregation SISO. The throughput for both CCs and the overall throughput are displayed.

### 3.3.2 “2CC CA – Fading – 4 RF Out” scenario (CA with MIMO)

This section covers all Carrier Aggregation scenarios with fading which need four RF output ports. These are:

- TM1 Rx Diversity (1x2 SIMO)
- TM2 Tx Diversity
- TM3 Open loop spatial multiplexing
- TM4 closed loop spatial multiplexing
- TM6 closed loop spatial multiplexing, single layer
- TM7 Single layer beamforming (port 5)
- TM8 Dual layer beamforming (ports 7,8)

The settings for PCC and SCC may differ. Everything is doubled now because of the two downlink carriers in Carrier Aggregation (PCC and SCC1). The settings for each CC are similar to the scenarios with one cell (see 3.2.2). Please note that two SMWs are necessary to provide the fading paths. The CMW allows free routing of the four streams to the output connectors to meet the DUT’s needs.

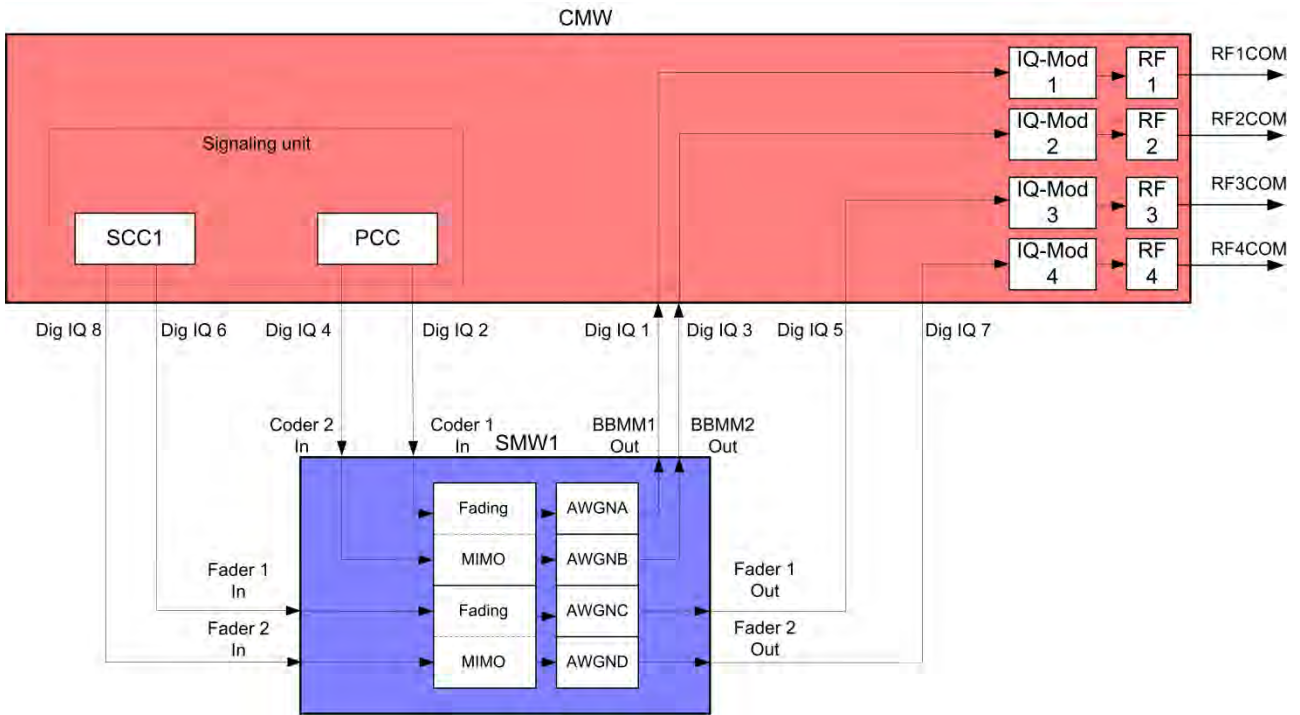

Fig. 3-47: Block diagram for the Carrier Aggregation MIMO test setup. The streams and the MIMO/Fading setup depend on the used transmission mode (TM)

The basic procedure for all the tests is the same, only the MIMO settings differ (TMs):

1. In the **LTE Signaling Configuration**, select the **2CC CA – Fading – 4 RF Out Scenario** (see Fig. 3-48). Set Fading to *External*.

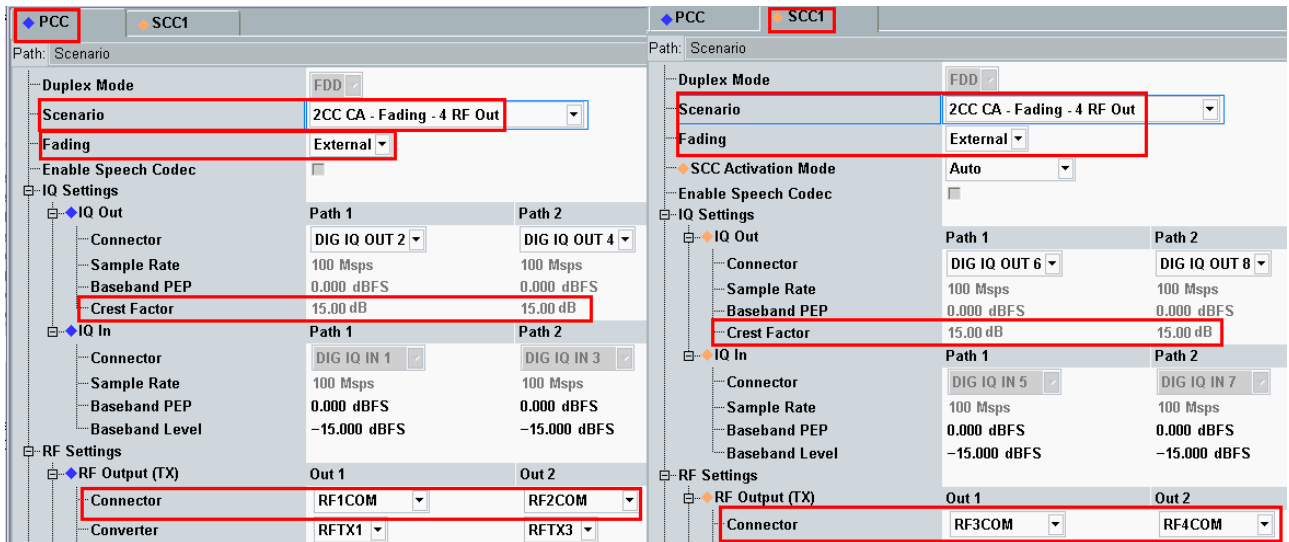

Fig. 3-48: LTE Scenario for Carrier Aggregation with MIMO and four RF out ports: 2CC CA – Fading – 4 RF Out Ports. The CMW indicates the crest factors, which are entered in the SMW's Dig IQ input.

Remote commands:

```
// 2CC CA-Fading-4 RF Out external: RF1C,IQ2Out, RF2C, IQ4Out
                                RF3C,IQ6Out, RF4C, IQ8Out

ROUTE:LTE:SIGN<i>:SCENario:CAFF
                                RF1C,RX1,RF1C, TX1, IQ2O, RF2C, TX3, IQ4O,
                                RF3C, TX2, IQ6O, RF4C, TX4, IQ8O

// read out information of IQ settings
SENSE:LTE:SIGN<i>:IQOut[:PCC]:PATH1?
SENSE:LTE:SIGN<i>:IQOut[:PCC]:PATH2?
SENSE:LTE:SIGN<i>:IQOut:SCC:PATH1?
SENSE:LTE:SIGN<i>:IQOut:SCC:PATH2?
```

2. Take note of the four **Crest Factors** shown under **IQ Out** and enter the values in both SMWs under **Baseband Input Level** (see Fig. 2-13 in section 2.3).
3. Set a fading for all paths and switch on **I/Q Out** (both SMWs: BBMM1|2)(see section 2.3).
4. In the CMW, enter both corresponding baseband levels (Level  $BB_{out\ SMW} = Crest\ Factor_{in\ SMW} - Insertion\ Loss$ ; example:  $-15\ dB - 10\ dB = -25\ dBFS$ , see 2.3.8 ), which are indicated by the SMWs (see Fig. 3-14). If you add noise to the signal, note the crest factor without noise.
5. Select a **TM** and a **DCI format** both for PCC and SCC1 (see 3.2.2 and also Table 3-2 for details).
6. Use **CONNECT** to establish an LTE connection between the CMW and DUT.
7. If you modify the fading, remember to change the level accordingly in the CMW.

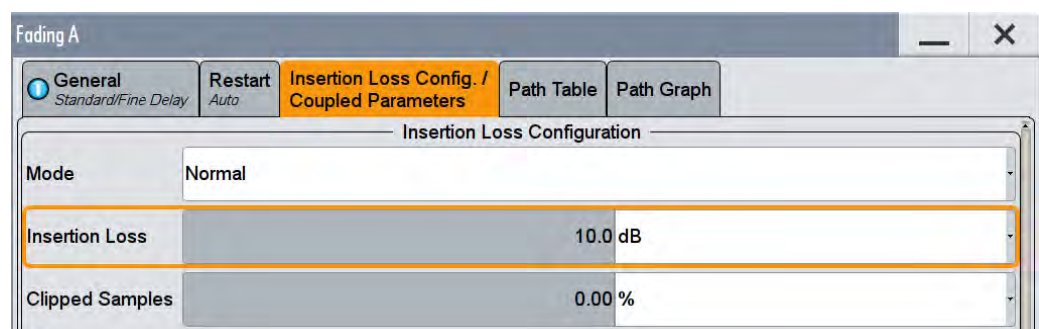

Fig. 3-49: The SMW shows the necessary insertion loss (example: 10 dB)

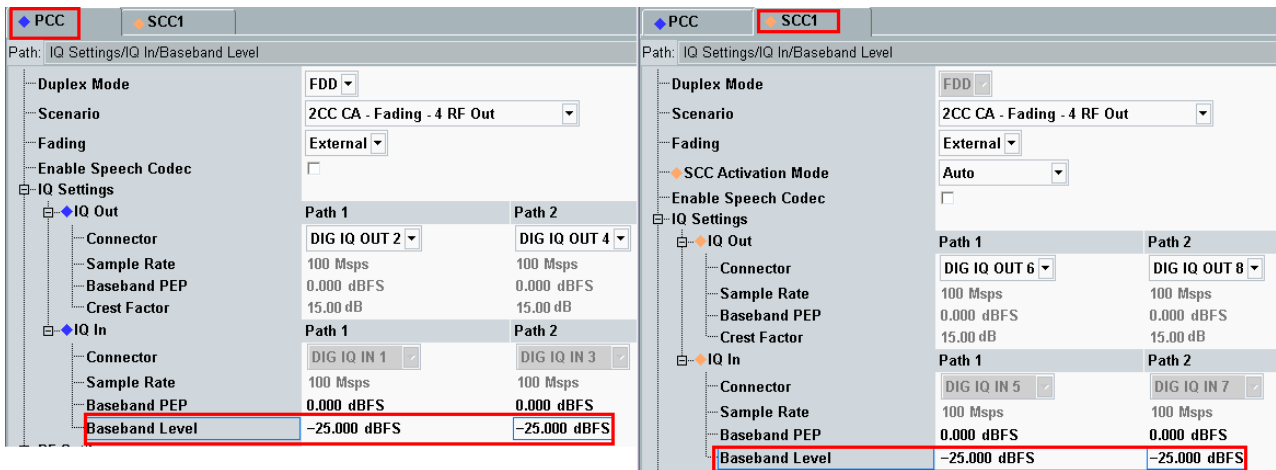

Fig. 3-50: Compensating for the necessary attenuation in the CMW. Here, the levels of the SMWs signals are entered as the IQ IN levels.

Remote commands:

```
// set IQ In to PEP 0 dBFS and Level -25 dBFS
CONFigure:LTE:SIGN<i>:IQIN[:PCC]:PATH1 0.0, -25.0
CONFigure:LTE:SIGN<i>:IQIN[:PCC]:PATH2 0.0, -25.0
CONFigure:LTE:SIGN<i>:IQIN:SCC:PATH1 0.0, -25.0
CONFigure:LTE:SIGN<i>:IQIN:SCC:PATH2 0.0, -25.0
```

8. Start the RX measurement using **Extended BLER** (see section 3.1)

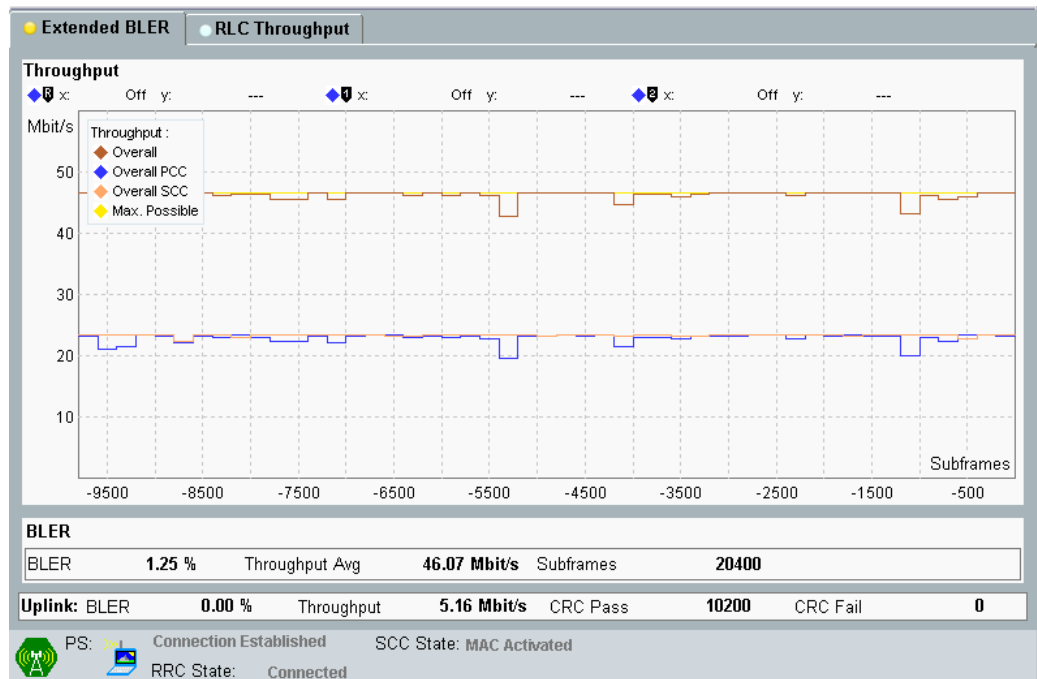

Fig. 3-51: Example for a Throughput measurement with four RF output paths: a CA test with TM4 (2x2 MIMO) for each CC is used.

### 3.4 Scenarios for Carrier Aggregation with CMWflexx

This section covers tests with carrier aggregation (CA) for more than two downlink component carriers (CC: Primary CC (PCC) and Secondary CC (SCCx)). Different transmission modes require different fading paths. In the CMW these scenarios differ by the number of the used RF outputs. The CMW supports all possible frequency allocations in CA (intra-band contiguous, intra-band non- contiguous and inter-band). All CCs can be set up independently of each other.



The CMWflexx provides more than 2 CC's with MIMO each, therefore more than one CMW is used. The CMW Controller (CMWC) allows easy manual and remote control, it acts like one CMW with extended RF hardware.

#### 3.4.1 “2CC CA – Fading – 4 RF Out Distributed” scenario (CA with MIMO)

This scenario is the same like in 3.3.2, with the difference that both CMW's are used so the RF ports are distributed over the two CMW's.

The procedure is the same like in 3.3.2, only the scenario setting and the used RF ports differ:

1. In the **LTE Signaling Configuration**, select the *2CC CA – Fading – 4 RF Out-Distributed Scenario* (see Fig. 3-48). Set **Fading** to *External*.

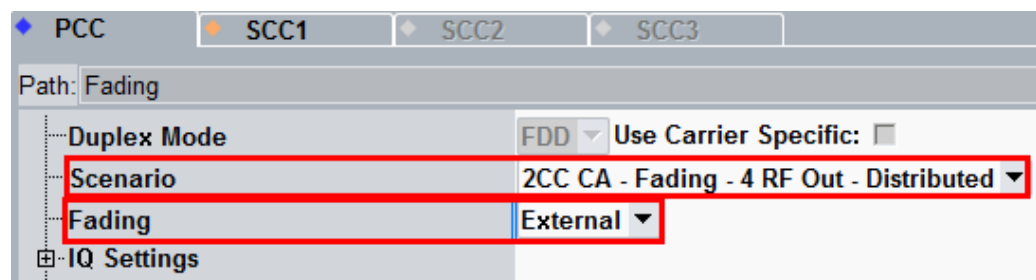

Fig. 3-52: LTE Scenario for Carrier Aggregation with MIMO and four distributed RF out ports: 2CC CA – Fading – 4 RF Out Distributed Ports. The CMW sets the used RF out ports automatically



Remote commands:

```
// 2CC CA-Fading-4 RF Out distributed external: routing is done  
// automatically. Use query to ask settings
```

```
ROUTE:LTE:SIGN<i>:SCENario:BDFD:FIX
```

### 3.4.2 “3CC CA – Fading – 6 RF Out” scenario (CA with 3 CC’s and MIMO)

This section covers all Carrier Aggregation scenarios with fading which need six RF output ports. These are:

- TM1 Rx Diversity (1x2 SIMO)
- TM2 Tx Diversity
- TM3 Open loop spatial multiplexing
- TM4 closed loop spatial multiplexing
- TM6 closed loop spatial multiplexing, single layer
- TM7 Single layer beamforming (port 5)
- TM8 Dual layer beamforming (ports 7,8)
- TM9 Dual layer beamforming (ports 7,8)

The settings for PCC, SCC1 and SCC2 may differ. Everything is tripled now because of the three downlink carriers in Carrier Aggregation (PCC, SCC1 and SCC2). The settings for each CC are similar to the scenarios with one cell (see 3.2.2). Please note that two SMWs are necessary to provide the fading paths.

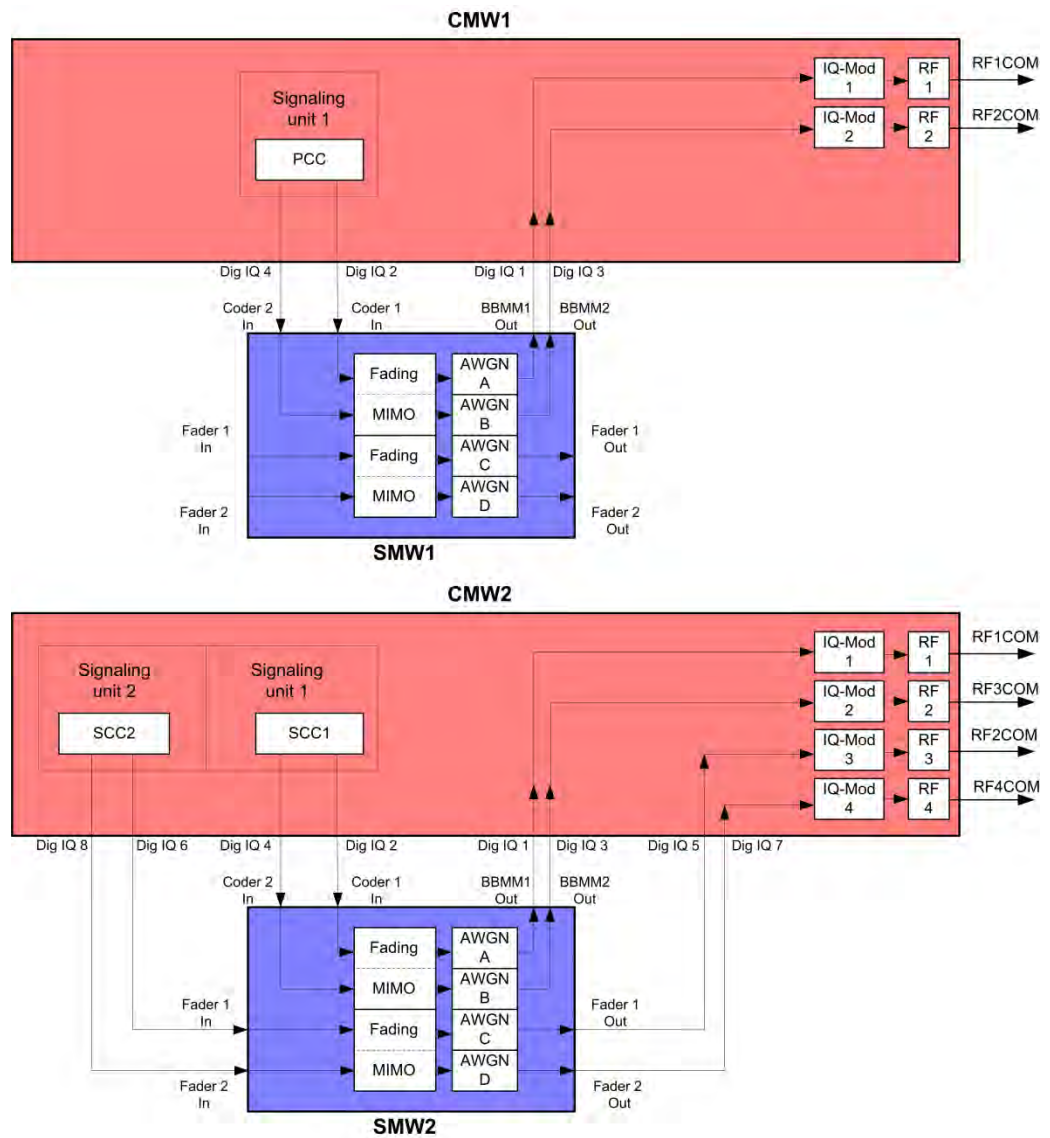

Fig. 3-53: Block diagram for the three Carrier Aggregation MIMO test setup. The streams and the MIMO/Fading setup depend on the used transmission mode (TM)

The basic procedure for all the tests is the same, only the MIMO settings differ (TMs):

2. In the **LTE Signaling Configuration**, select the **3CC CA – Fading – 6 RF Out Scenario** (see Fig. 3-48). Set **Fading** to *External*.

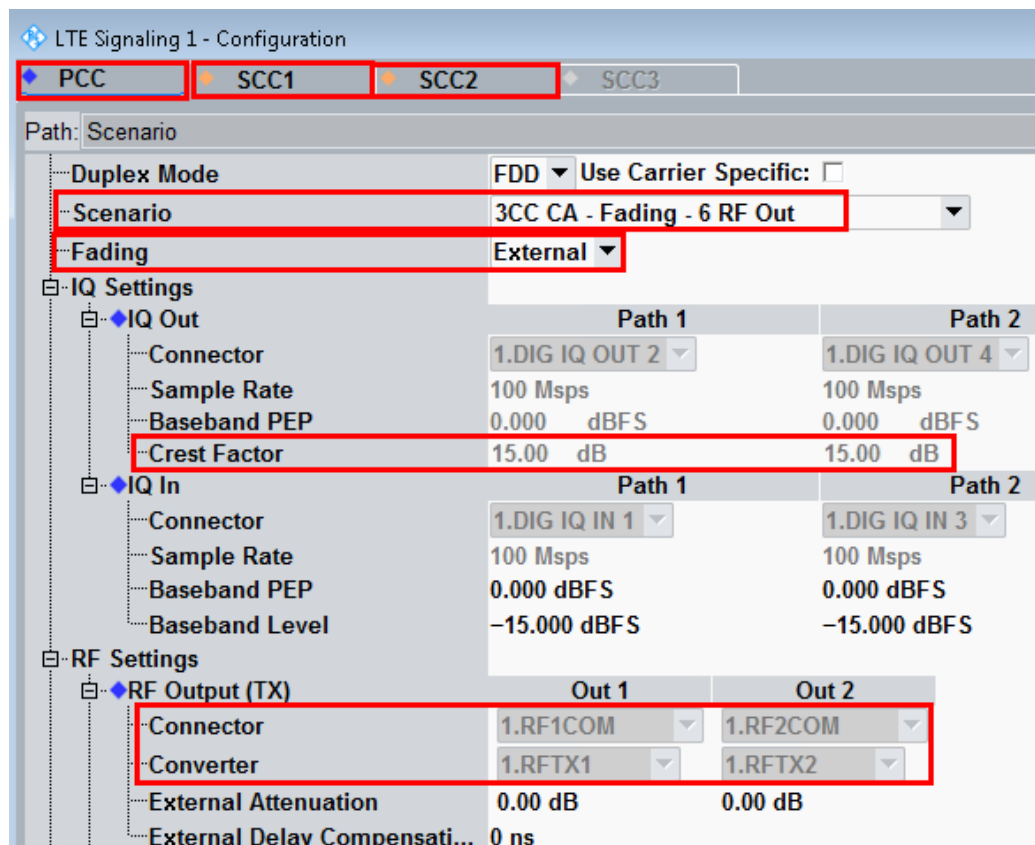

Fig. 3-54: LTE Scenario for Carrier Aggregation with MIMO and six RF out ports: 3CC CA – Fading – 6 RF Out Ports. The CMW indicates the crest factors, which are entered in the SMW's Dig IQ input.

Remote commands:

```
// 3CC CA-Fading-6 RF Out external: routing is done
// automatically. Use query to ask settings
```

```
ROUTE:LTE:SIGN<i>:SCENario:CFE:FIX
```

```
// read out information of IQ settings
SENSE:LTE:SIGN<i>:IQOut[:PCC]:PATH1?
SENSE:LTE:SIGN<i>:IQOut[:PCC]:PATH2?
SENSE:LTE:SIGN<i>:IQOut:SCC1:PATH1?
SENSE:LTE:SIGN<i>:IQOut:SCC1:PATH2?
SENSE:LTE:SIGN<i>:IQOut:SCC2:PATH1?
SENSE:LTE:SIGN<i>:IQOut:SCC2:PATH2?
```

3. Take note of the six **Crest Factors** shown under **IQ Out** and enter the values in both SMWs under **Baseband Input Level** (see Fig. 2-13 in section 2.3).
4. Set a fading for all paths and switch on **I/Q Out** (both SMWs: BBMM1|2)(see section 2.3).

5. In the CMW, enter all six corresponding baseband levels (Level  $BB_{out\ SMW} = Crest\ Factor_{In\ SMW} - Insertion\ Loss$ ; example:  $-15\ dB - 16\ dB = -31\ dBFS$ , see 2.3.8), which are indicated by the SMWs (see Fig. 3-14). If you add noise to the signal, note the crest factor without noise.
6. Select a **TM** and a **DCI format** for PCC, SCC1 and SCC2 (see 3.2.2 and also Table 3-2 for details).
7. Use **CONNECT** to establish an LTE connection between the CMW and DUT.
8. If you modify the fading, remember to change the level accordingly in the CMW.

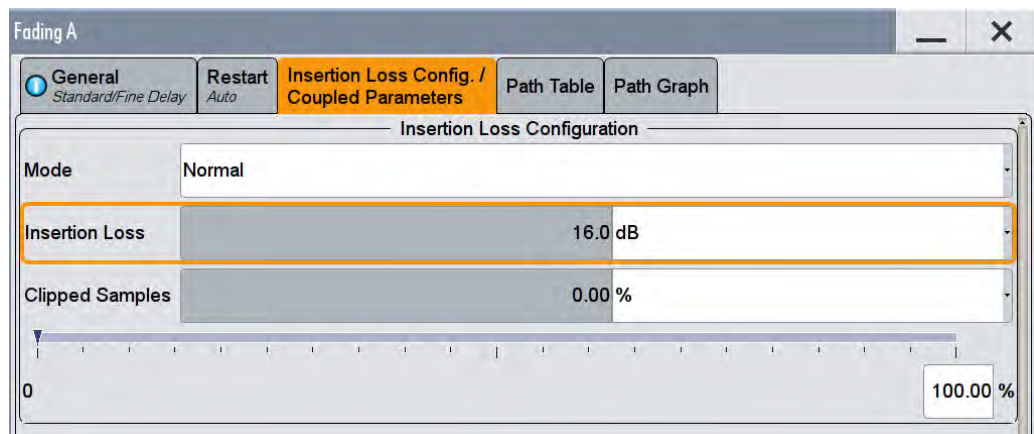

Fig. 3-55: The SMW shows the necessary insertion loss (example: 16 dB)

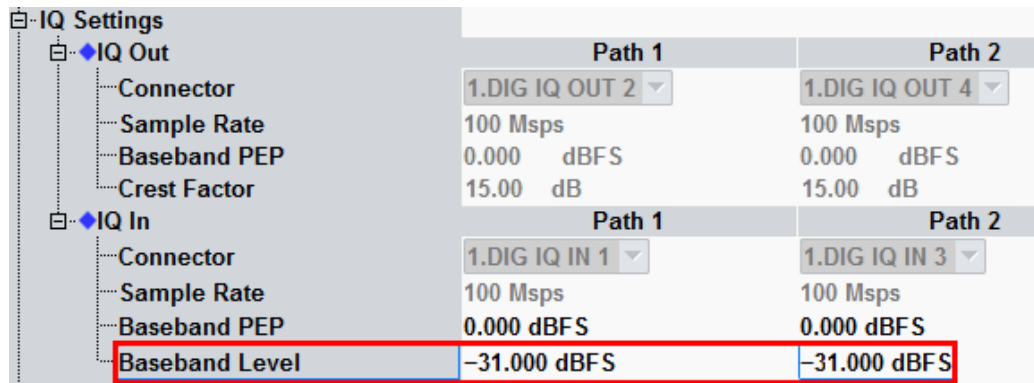

Fig. 3-56: Compensating for the necessary attenuation in the CMW. Here, the levels of the SMWs signals are entered as the IQ IN levels. Repeat this for all CC's.

Remote commands:

```
// set IQ In to PEP 0 dBFS and Level -31 dBFS
CONFigure:LTE:SIGN<i>:IQIN[:PCC]:PATH1 0.0, -315.0
CONFigure:LTE:SIGN<i>:IQIN[:PCC]:PATH2 0.0, -31.0
CONFigure:LTE:SIGN<i>:IQIN:SCC1:PATH1 0.0, -31.0
CONFigure:LTE:SIGN<i>:IQIN:SCC1:PATH2 0.0, -31.0
CONFigure:LTE:SIGN<i>:IQIN:SCC2:PATH1 0.0, -31.0
CONFigure:LTE:SIGN<i>:IQIN:SCC2:PATH2 0.0, -31.0
```

9. Start the RX measurement using **Extended BLER** (see section 3.1)

### 3.4.3 “4CC CA – Fading – 8 RF Out” scenario (CA with 4 CC’s and MIMO)

This section covers all Carrier Aggregation scenarios with fading which need eight RF output ports. These are:

- TM1 Rx Diversity (1x2 SIMO)
- TM2 Tx Diversity
- TM3 Open loop spatial multiplexing
- TM4 closed loop spatial multiplexing
- TM6 closed loop spatial multiplexing, single layer
- TM7 Single layer beamforming (port 5)
- TM8 Dual layer beamforming (ports 7,8)
- TM9 Dual layer beamforming (ports 7,8)

The settings for PCC, SCC1, SCC2 and SCC3 may differ. Everything is four times available now because of the four downlink carriers in Carrier Aggregation (PCC, SCC1, SCC2 and SCC3). The settings for each CC are similar to the scenarios with one cell (see 3.2.2). Please note that two SMWs are necessary to provide the fading paths.

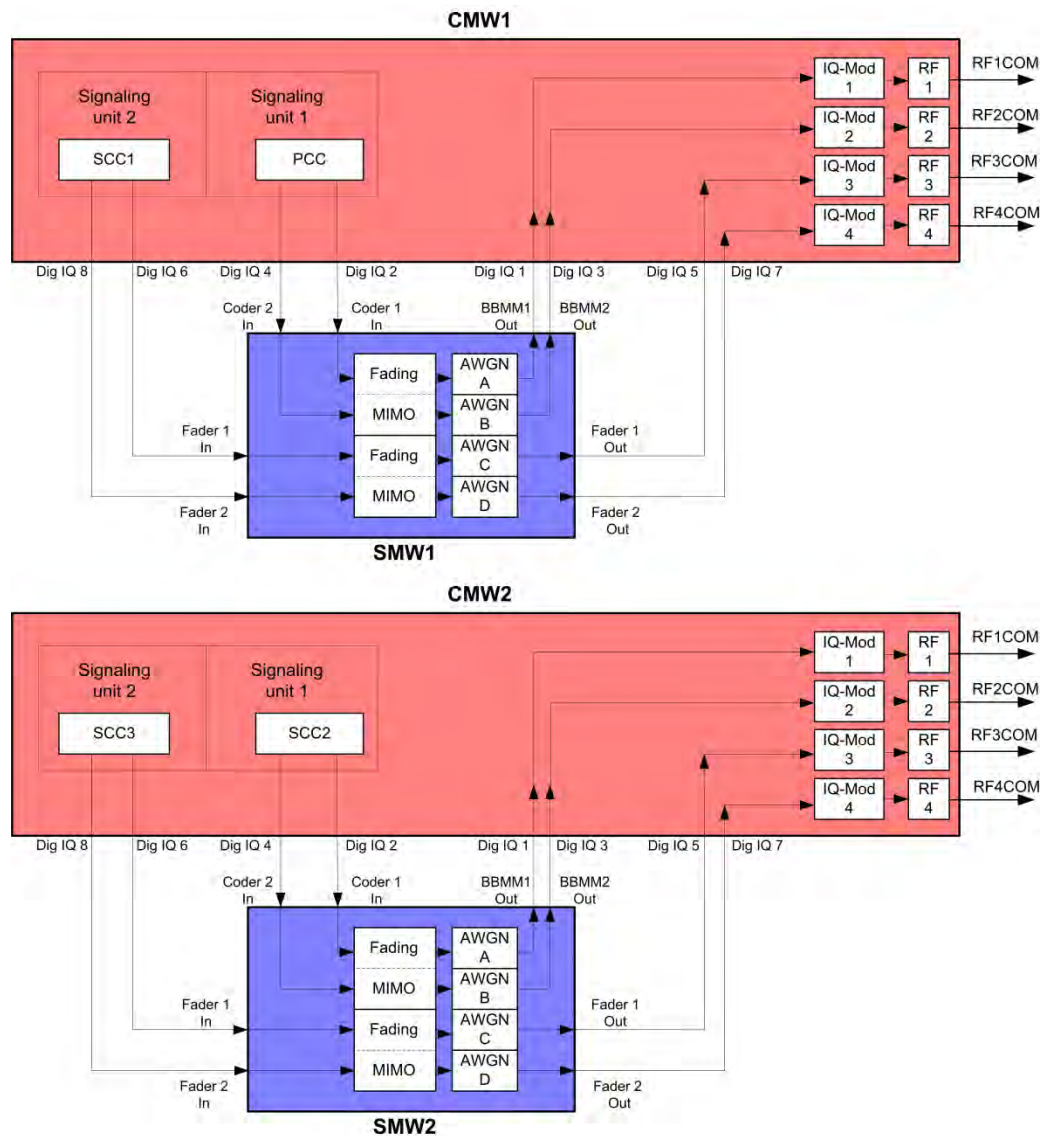

Fig. 3-57: Block diagram for the Carrier Aggregation MIMO test setup. The streams and the MIMO/Fading setup depend on the used transmission mode (TM)

The basic procedure for all the tests is the same, only the MIMO settings differ (TMs):

1. In the **LTE Signaling Configuration**, select the **4CC CA – Fading – 8 RF Out Scenario** (see Fig. 3-48). Set **Fading** to *External*.

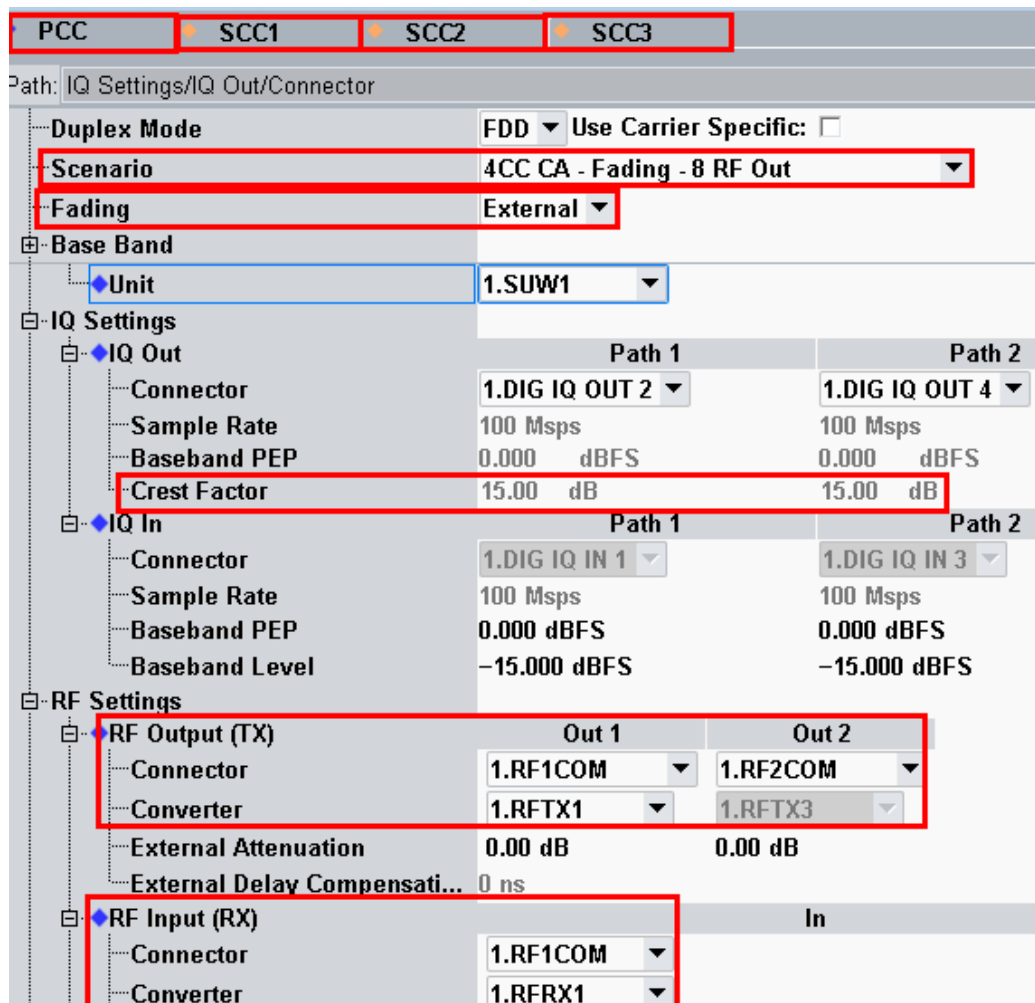

Fig. 3-58: LTE Scenario for Carrier Aggregation with MIMO and eight RF out ports: 4CC CA – Fading – 8 RF Out Ports. The CMW indicates the crest factors, which are entered in the SMW's Dig IQ input.

Remote commands:

```
// 4CC CA-Fading-8 RF Out external: routing is done
// automatically. Use query to ask settings
```

```
ROUTE:LTE:SIGN<i>:SCENario:DHF:FIX
```

```
// read out information of IQ settings
SENSE:LTE:SIGN<i>:IQOut[:PCC]:PATH1?
SENSE:LTE:SIGN<i>:IQOut[:PCC]:PATH2?
SENSE:LTE:SIGN<i>:IQOut:SCC1:PATH1?
SENSE:LTE:SIGN<i>:IQOut:SCC1:PATH2?
SENSE:LTE:SIGN<i>:IQOut:SCC2:PATH1?
SENSE:LTE:SIGN<i>:IQOut:SCC2:PATH2?
SENSE:LTE:SIGN<i>:IQOut:SCC3:PATH1?
SENSE:LTE:SIGN<i>:IQOut:SCC3:PATH2?
```

2. Take note of the eight **Crest Factors** shown under **IQ Out** and enter the values in both SMWs under **Baseband Input Level** (see Fig. 2-13 in section 2.3).
3. Set a fading for all paths and switch on **I/Q Out** (both SMWs: BBMM1|2)(see section 2.3).
4. In the CMW, enter all eight corresponding baseband levels (Level  $BB_{out\ SMW} = Crest\ Factor_{in\ SMW} - Insertion\ Loss$ ; example:  $-15\ dB - 16\ dB = -31\ dBFS$ , see 2.3.8 ), which are indicated by the SMWs (see Fig. 3-14). If you add noise to the signal, note the crest factor without noise.
5. Select a **TM** and a **DCI format** for PCC, SCC1, SCC2 and SCC3 (see 3.2.2 and also Table 3-2 for details).
6. Use **CONNECT** to establish an LTE connection between the CMW and DUT.
7. If you modify the fading, remember to change the level accordingly in the CMW.

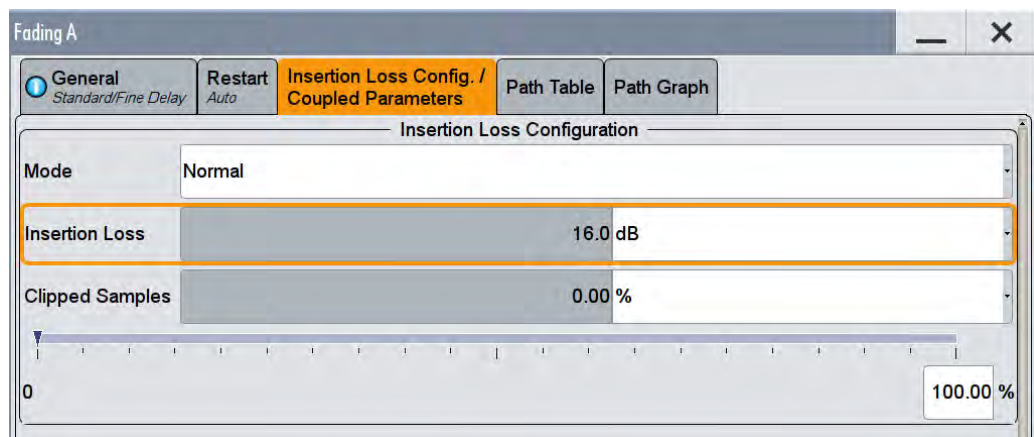

Fig. 3-59: The SMW shows the necessary insertion loss (example: 16 dB)

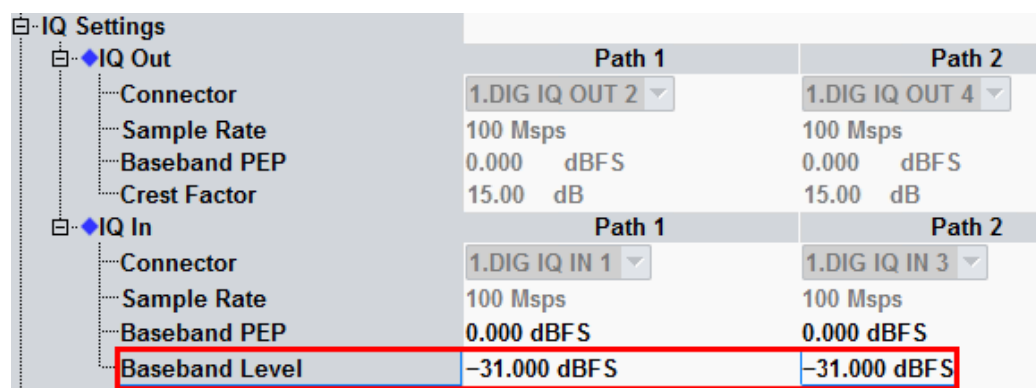

Fig. 3-60: Compensating for the necessary attenuation in the CMW. Here, the levels of the SMWs signals are entered as the IQ IN levels. Repeat this for all CC's.



Remote commands:

```
// set IQ In to PEP 0 dBFS and Level -31 dBFS
CONFigure:LTE:SIGN<i>:IQIN[:PCC]:PATH1 0.0, -31.0
CONFigure:LTE:SIGN<i>:IQIN[:PCC]:PATH2 0.0, -31.0
CONFigure:LTE:SIGN<i>:IQIN:SCC1:PATH1 0.0, -31.0
CONFigure:LTE:SIGN<i>:IQIN:SCC1:PATH2 0.0, -31.0
CONFigure:LTE:SIGN<i>:IQIN:SCC2:PATH1 0.0, -31.0
CONFigure:LTE:SIGN<i>:IQIN:SCC2:PATH2 0.0, -31.0
CONFigure:LTE:SIGN<i>:IQIN:SCC3:PATH1 0.0, -31.0
CONFigure:LTE:SIGN<i>:IQIN:SCC3:PATH2 0.0, -31.0
```

8. Start the RX measurement using **Extended BLER** (see section 3.1)

### 3.5 CMW Internal Fading for LTE(-A)

For all of the above Fading scenarios (see also [Table 3-2](#)):

- 1 Cell – Fading- 1 RF out
- 1 Cell – Fading- 2 RF out
- 1 Cell 4x2 MIMO Fading 2 RF out
- 2CC CA – Fading – 2 RF out (PCC and SCC1)
- 2CC CA – Fading – 4 RF out (PCC and SCC1)
- 2CC CA – Fading – 4 RF out distributed (PCC and SCC1)
- 3CC CA – Fading – 6 RF out (PCC, SCC1 and SCC2)
- 4CC CA – Fading – 8 RF out (PCC, SCC1, SCC2 and SCC3)

the internal fading in the CMW can be used with the software option CMW-KE500. It allows the predefined fading settings:

- Delay profiles (3GPP TS 36.101, Annex B.2.)
  - EPA 5 Hz
  - EVA 5 Hz
  - EVA 70 Hz
  - ETA 30 Hz
  - ETA 70 Hz
  - ETA 300 Hz
  - For MIMO all with low, mid and high correlation
- High speed train profile (HST) (3GPP TS 36.101, Annex B.3.)
- Multi-path profile for CQI tests (3GPP TS 36.521-1, section 9.3.)

1. Set the wanted fading scenario and set Fading to Internal.

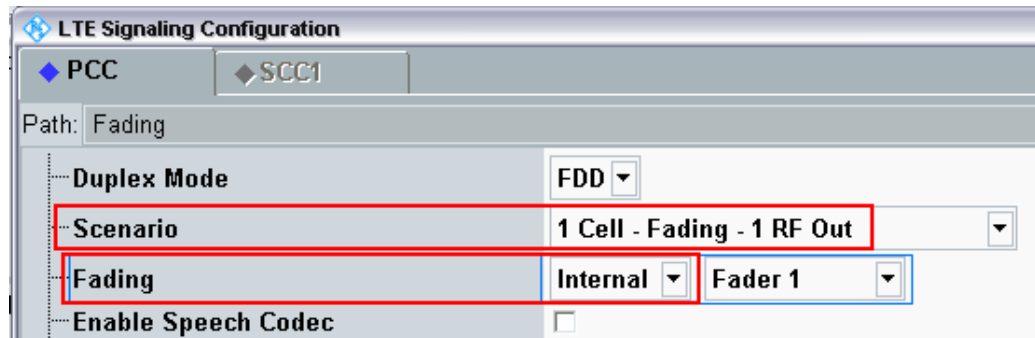

Fig. 3-61: LTE scenario with internal fading

Remote commands:

```
// 1 Cell-Fading- 1 RF Out internal via RF2COM
ROUTE:LTE:SIGN:SCENario:SCFading:INTernal RF2C,RX1,RF2C,TX1
// 1 Cell-Fading-2 RF Out internal: RF2C,IQ2Out, RF1C
ROUTE:LTE:SIGN<i>:SCENario:TROFading:INTernal
    RF1C,RX1,RF1C,TX1,RF3C,TX2,FAD1

// 1 Cell-Fading-MIMO 4x2 - 2 RF Out internal:
ROUTE:LTE:SIGN<i>:SCENario:MTF:INTernal
    RF1C,RX1,RF1C,TX1,RF2C,TX3

// 2CC CA-Fading- 2 RF Out internal via RF1COM, RF3COM
ROUTE:LTE:SIGN:SCENario:CATF:INTernal
    RF1C,RX1,RF1C,TX1,RF3C,TX2
// 2CC CA-Fading-4 RF Out internal: RF1C, RF2C, RF3C, RF4C
ROUTE:LTE:SIGN<i>:SCENario:CAFF:INTernal
    RF1C,RX1,RF1C,TX1,RF2C,TX3,RF3C,TX2,RF4C,TX4

// 2CC CA-Fading-4 RF Out distributed external: routing is done
// automatically. Use query to ask settings
ROUTE:LTE:SIGN<i>:SCENario:BDFD:FIX:INTernal

// 3CC CA-Fading-6 RF Out external: routing is done
// automatically. Use query to ask settings
ROUTE:LTE:SIGN<i>:SCENario:CFF:FIX:INTernal

// 4CC CA-Fading-8 RF Out external: routing is done
// automatically. Use query to ask settings
ROUTE:LTE:SIGN<i>:SCENario:DHF:FIX:INTernal
```

2. Select under **Fading Simulator** the wanted **Profile** (example EPA 5Hz Low)
3. **Enable** the Fading

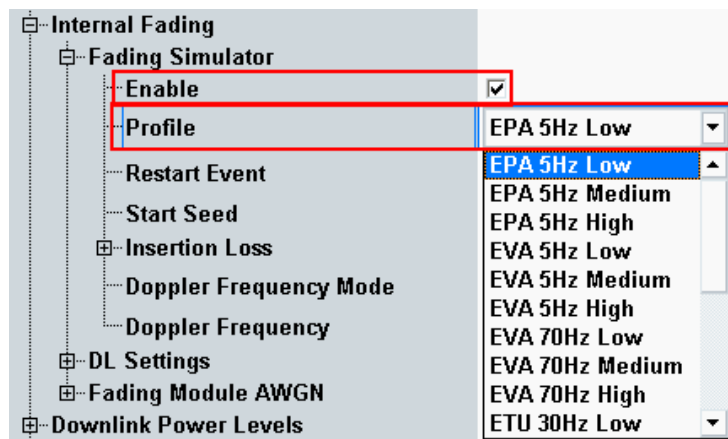

Fig. 3-62: internal LTE fading profiles

Remote commands:

```
// Fading profile EPA 56 Hz low
CONFigure:LTE:SIGN<i>:FADing[:PCC]:FSIMulator:STANdard EP5Low
CONFigure:LTE:SIGN<i>:FADing:SCC:FSIMulator:STANdard EP5Low

// Switch on FADing
CONFigure:LTE:SIGN<i>[:PCC]:FADing:FSIMulator:ENABLE ON
CONFigure:LTE:SIGN<i>:SCC:FADing:FSIMulator:ENABLE ON
```

4. If wanted, apply AWGN by setting the **Signal/Noise-ratio** and **enable** the AWGN.

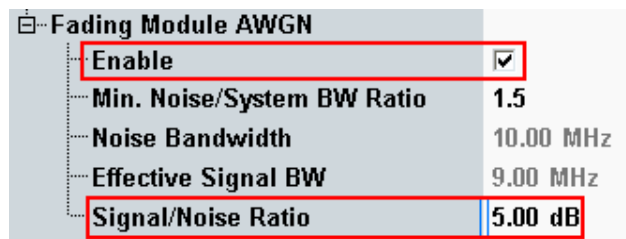

Fig. 3-63: internal LTE AWGN section

Remote commands:

```
// Ratio 1.5
CONFigure:LTE:SIGN<i>:FADing[:PCC]:AWGN:BWIDth:RATio 1.5
CONFigure:LTE:SIGN<i>:FADing:SCC:AWGN:BWIDth:RATio 1.5

// Signal/Noise 5.0
CONFigure:LTE:SIGN<i>:FADing[:PCC]:AWGN:SNRratio 5.0
CONFigure:LTE:SIGN<i>:FADing:SCC]:AWGN:SNRratio 5.0

// Switch on AWGN
CONFigure:LTE:SIGN<i>:FADing[:PCC]:AWGN:ENABLE ON
CONFigure:LTE:SIGN<i>:FADing:SCC]:AWGN:ENABLE ON
```

5. Start the measurement (see 3.1).

## 4 W-CDMA and HSPA(+) Measurements

With the W-CDMA standard, UE receiver measurements include different types of measurements depending on the release:

W-CDMA Rx measurements				
Release	Name	DL / UL Carrier		Measurement
99	RMC	1 / 1		BER
5	HSDPA	1 / 1		HSDPA ACK (BLER)
6	HSUPA	1 / 1		E-HICH
7	HSPA+	1 / 1		HSDPA ACK (BLER)
8	Dual Cell HSDPA	2 / 1		HSDPA ACK (BLER)
9	DC-HSUPA	2 / 2		E-HICH
	Dual-Band HSDPA	2 / 1		HSDPA ACK (BLER)
10	Four Carrier HSDPA	CMW: 3 / 2		HSDPA ACK (BLER)

All measurements are summarized in the **WCDMA RX Meas** test and measurement applications (see 4.1).

Before the start of the W-CDMA signaling, external fading must be selected as the scenario. Once signaling has begun, or once a connection has been established with the DUT, it is no longer possible to change scenarios.

Different antenna configurations are possible with W-CDMA. They also require different ways of handling fading:

W-CDMA scenarios			
W-CDMA scenario	Purpose	Release	CMW configuration
SISO	Standard	99/5/6/7	Standard cell fading
SIMO	Rx Diversity	99/5/6/7	Standard cell Rx Diversity fading
Dual Carrier	DC-HSPA+	5/7/8	Dual Carrier Fading
DC – SIMO	DC-HSPA+ with RX Diversity	5/7/8	Dual Carrier Rx Diversity Fading
Dual Band	DB-DC-HSDPA+	5/7/8/9	Dual Carrier / Dual Band Fading
Dual Band - SIMO	DB-DC-HSDPA+ with RX Diversity	5/7/8/9	Dual Carrier / Dual Band Fading Rx Diversity

**Table 4-1: W-CDMA scenarios in the CMW.**

This section describes the steps required to perform a W-CDMA Rx measurement under several different conditions, such as SISO or DC-HSPA+ fading.

For more information on W-CDMA signaling or on W-CDMA Rx measurements, refer to [6].

**Important note:** The CMW and the SMW use DigIQ connections to exchange the signals. The correct setting of the crest factor is essential for the fading and the correct RF level handling (see sections 4.2 to 4.5). The crest factor of the CMW depends on

the settings of the channels and the connection state. Please check the crest factor settings after establishing the connections. Re-adjustments may be necessary.

For W-CDMA, the CMW offers “wizards”. They make it very easy to configure the parameters for specific test cases. To do this, the CMW reads the UE report and sets the corresponding parameters – e.g. for maximum throughput (see Fig. 4-1).



Fig. 4-1: The WCDMA wizard

## 4.1 UE Receiver Measurement in W-CDMA: Rx Meas

The CMW sends data to the UE either via RMC or HSPA subframes and determines the block error rate (BLER) from the positive ACKnowledgments (ACK) and negative ACKnowledgments (NACK) returned by the UE. Additional throughput results are calculated from the BLER results. The CQI indices reported by the UE are also evaluated.

Fig. 4-2 through Fig. 4-4 show examples of the different measurements under fading conditions.

BER

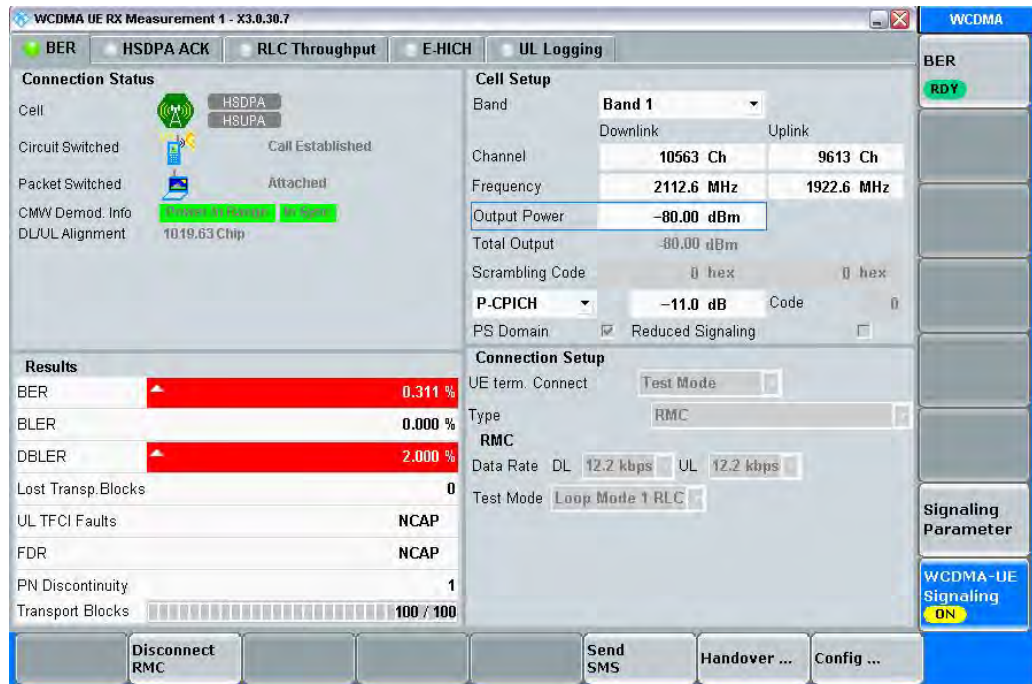

Fig. 4-2: W-CDMA BER Measurement on DCH (RMC) Rel 99. The UE loops back the data stream sent from the CMW. The CMW determines the bit error rate (BER) and from that also determines the block error rates.

Remote commands:

```

CONFigure:WCDMa:SIGN<i>:BER:TBLocks 10000 // set 10000 blocks
INITiate:WCDMa:SIGN<i>:BER // start measurement
FETCh:WCDMa:SIGN<i>:BER? // get results
    
```

HSDPA ACK

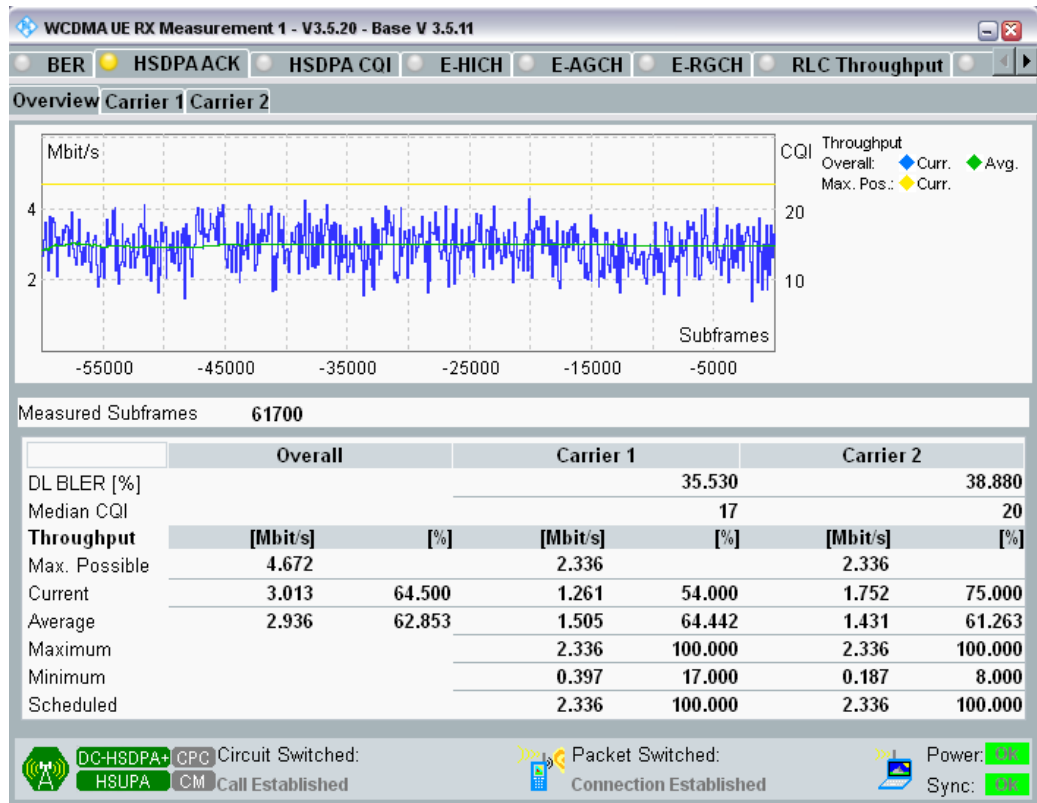

Fig. 4-3: W-CDMA HSDPA ACK Measurement on HSPA channels. For each data block, the UE sends an ACK or NACK back to the CMW. The CMW counts the ACK/NACKs and calculates the block error rate (BLER) and, from that, the throughput.

Remote commands:

```
//set 10000 subframes
CONFigure:WCDMa:SIGN<i>:HACK:MSFRames 10000
// start measurement
INITiate:WCDMa:SIGN<i>:HACK
// get results
FETCh:WCDMa:SIGN<i>:HACK:TRACe:THROUGHput:TOTAL:CURRENT?
```

## E-HICH

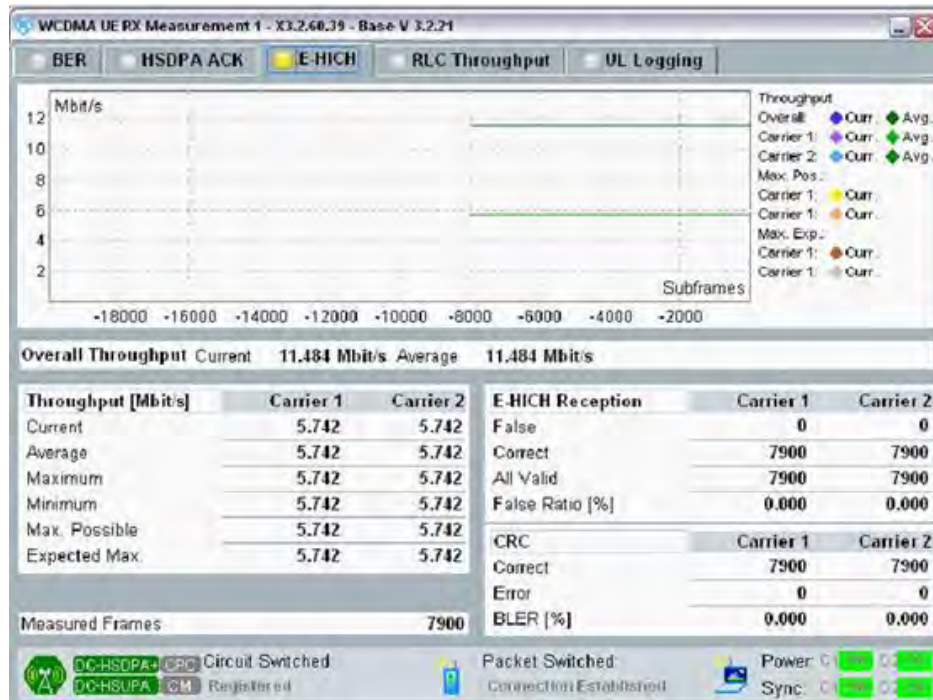

Fig. 4-4: W-CDMA HSUPA E-HICH measurement on HSPA channels in line with Rel 6. On the uplink channels, the CMW measures the UE's reaction to the information in the downlink channels. The E-HICH measurement also supports DC-HSUPA with two carriers.

## Remote commands:

```
CONFigure:WCDMa:SIGN<i>:EHICH:MFRames 10000 //set 10000
                                         subframes
INITiate:WCDMa:SIGN<i>:EHICH           // start measurement
FETCh:WCDMa:SIGN<i>:EHICH?             // get results
```

## 4.2 SISO Configuration

In this configuration, only one data stream is used via one antenna. For this, it is only necessary to fade one path. That can be done with one channel of the SMW.



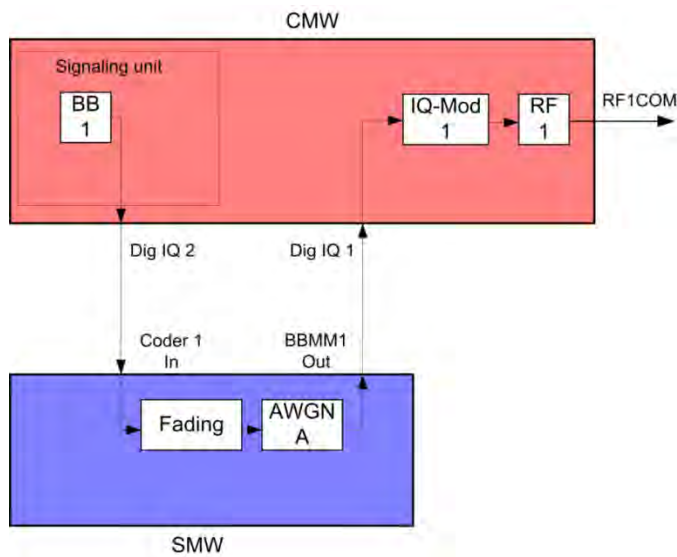

Fig. 4-5: Block diagram for the SISO test setup.

1. In the WCDMA **Signaling Configuration**, select the *Standard Cell Fading Scenario* (see Fig. 4-6). Set **Fading** to *External*.

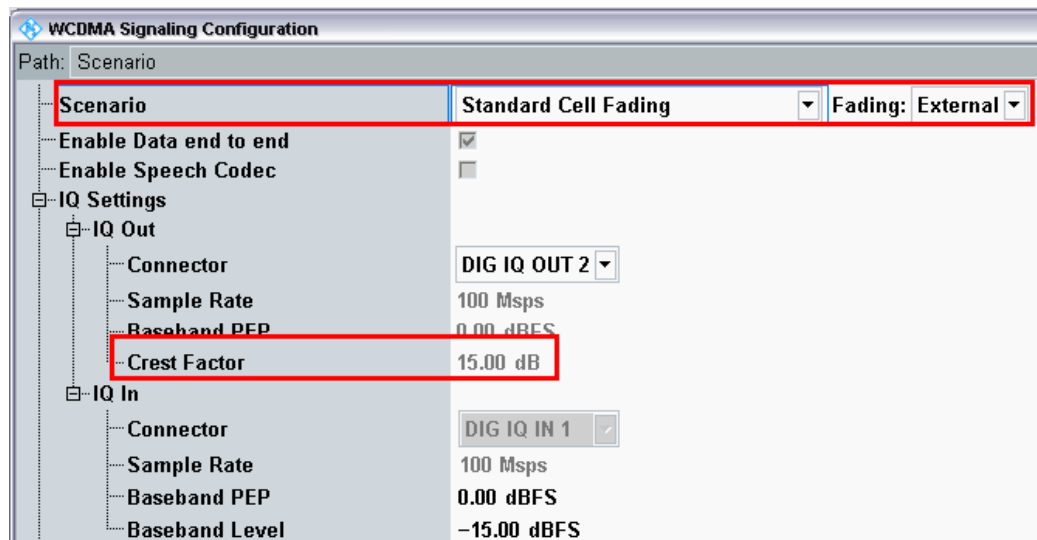

Fig. 4-6: WCDMA scenario for SISO: Standard Cell Fading. The CMW indicates the crest factor that is entered in the SMW Dig IQ Input.

Remote commands:

```
// Standard Cell Fading external with RF2C and IQ 2
ROUTE:WCDMa:SIGN:SCENario:SCFading RF2C,RX1,RF2C, TX1, IQ20
// read out IQ settings
SENSe:WCDMa:SIGN<i>:IQOut:CARRier<carrier>?
```

2. Take note of the **Crest Factor** under **IQ Out** and enter this value in the SMW under **Baseband Input Level** (see Fig. 2-13 in section 2.3).

3. Set a fading and switch on **I/Q Out** (BBMM1)(see section 2.3).
4. In the CMW, enter the corresponding baseband level ( $\text{Level BB}_{\text{out SMW}} = \text{Crest Factor}_{\text{In SMW}} - \text{Insertion Loss}$ ; example:  $-15.0 \text{ dB} - 10 \text{ dB} = -25.0 \text{ dBFS}$ , see 2.3.8), which is indicated by the SMW (see Fig. 4-8). If you add noise to the signal, note the crest factor without noise.
5. Establish a W-CDMA connection between the CMW and DUT, e.g. using **CONNECT HSPA TM**.
6. If you modify the fading, remember to change the level accordingly in the CMW.

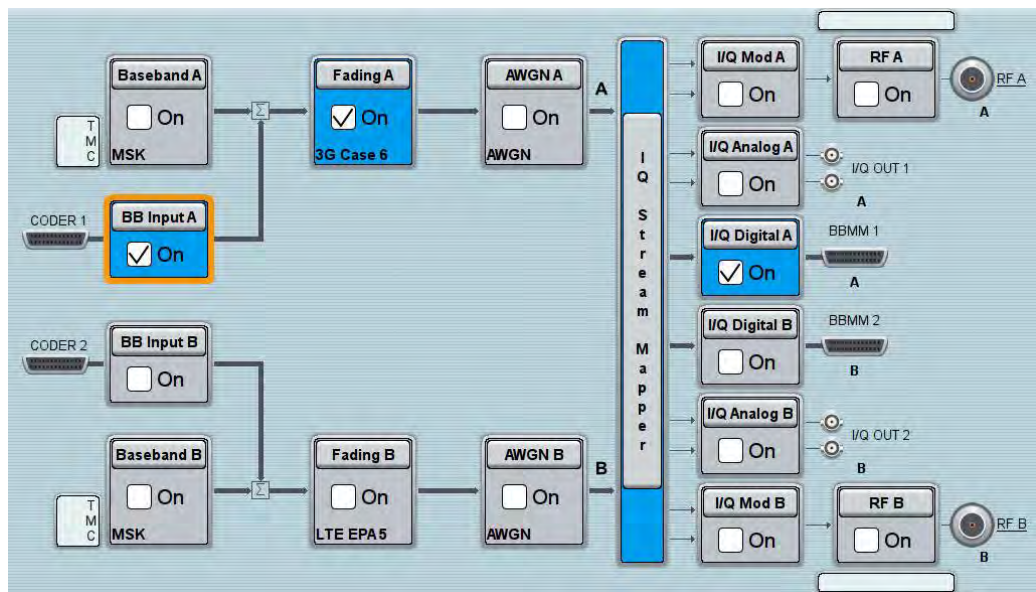

Fig. 4-7: SMW settings for SISO fading.

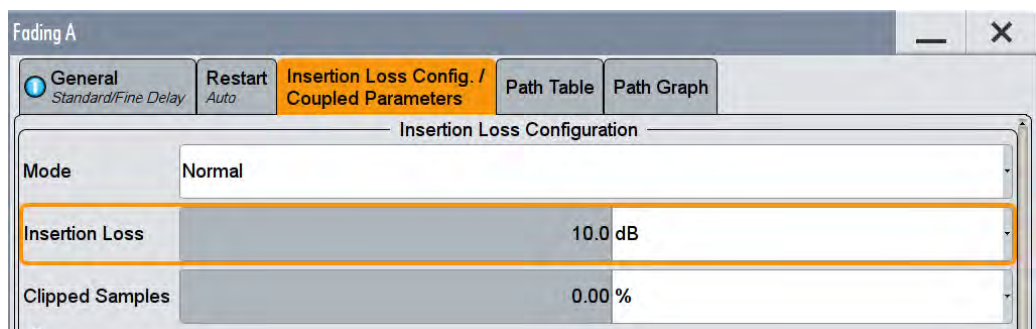

Fig. 4-8: The SMW shows the necessary insertion loss (example: 10 dB)

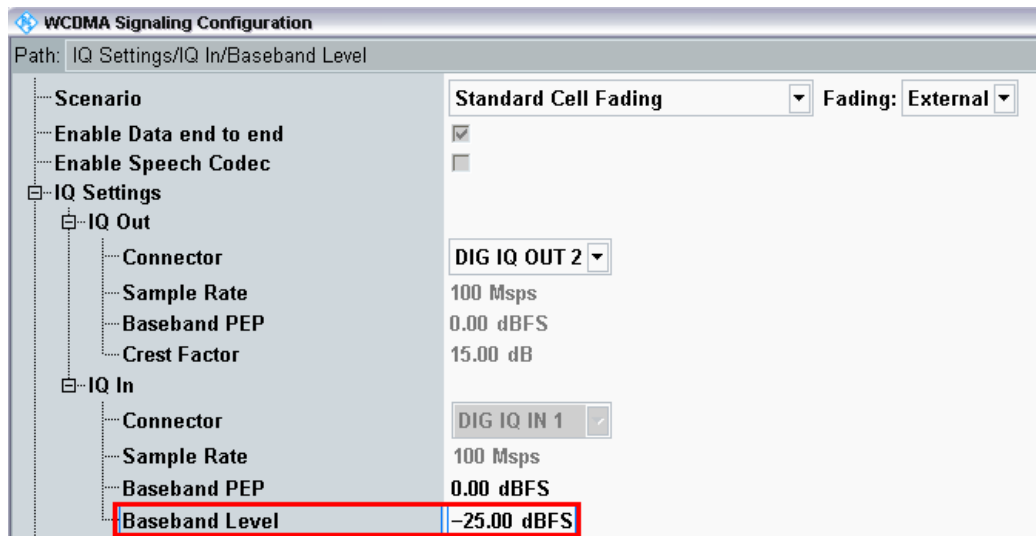

Fig. 4-9: Compensating the necessary attenuation in the CMW. Here, the level of the SMW signal is entered as the IQ IN level.

Remote command:

```
// set IQ in to PEP 0 dBFS and Level to -26.77 dBFS
CONFigure:WCDMa:SIGN<i>:IQIN:CARRIER<carrier> 0, -26.77
```

- Start the RX measurement via **WCDMA Rx Meas.** (see section 4.1). Fig. 4-10 shows an example of the SISO measurement in the overview.



Fig. 4-10: WCDMA RX measurement for SISO.

### 4.3 Rx Diversity Configuration (SIMO)

Rx Diversity simulates the two different receiving paths of the UE. The second path is provided by the CMW via RFCOM2.

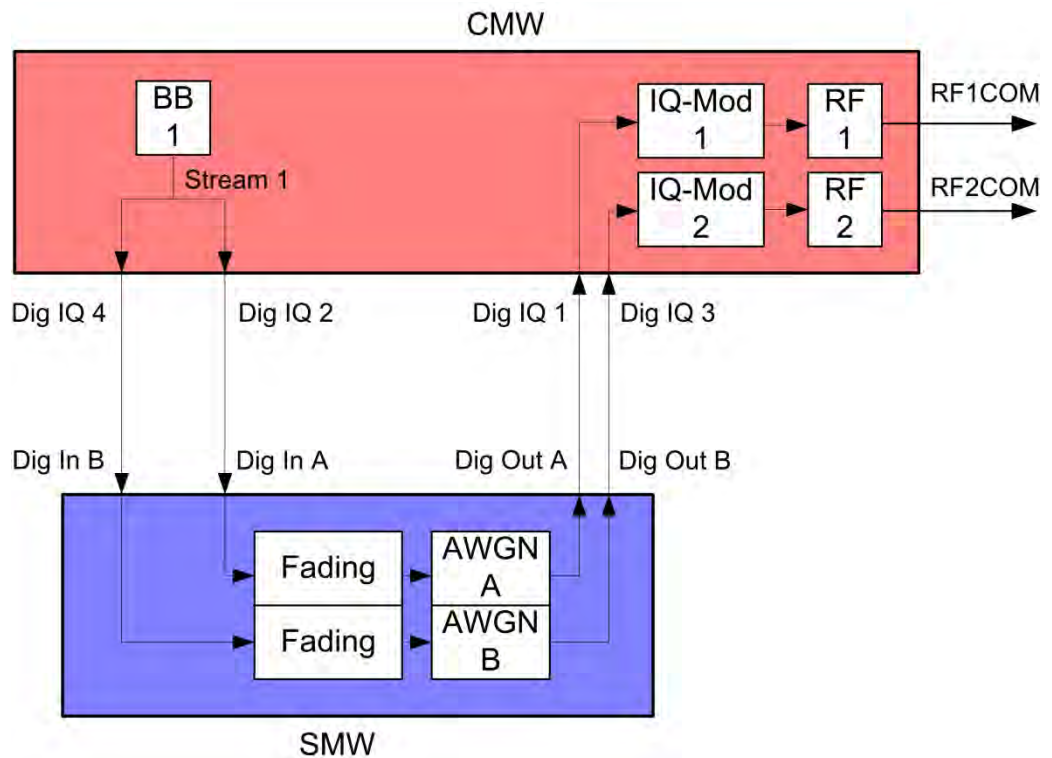

Fig. 4-11: Block diagram for the Rx Diversity test setup. One carrier is split up in two paths and transmitted via two antennas and with different fading.

1. In the **WCDMA Signaling Configuration**, select the *Standard Cell Rx Diversity Fading Scenario* (see Fig. 4-18). Set **Fading** to *External*. The CMW can accommodate different antenna configurations for the UE. Output for the second carrier can either be provided through the same RF port or through a separate one.

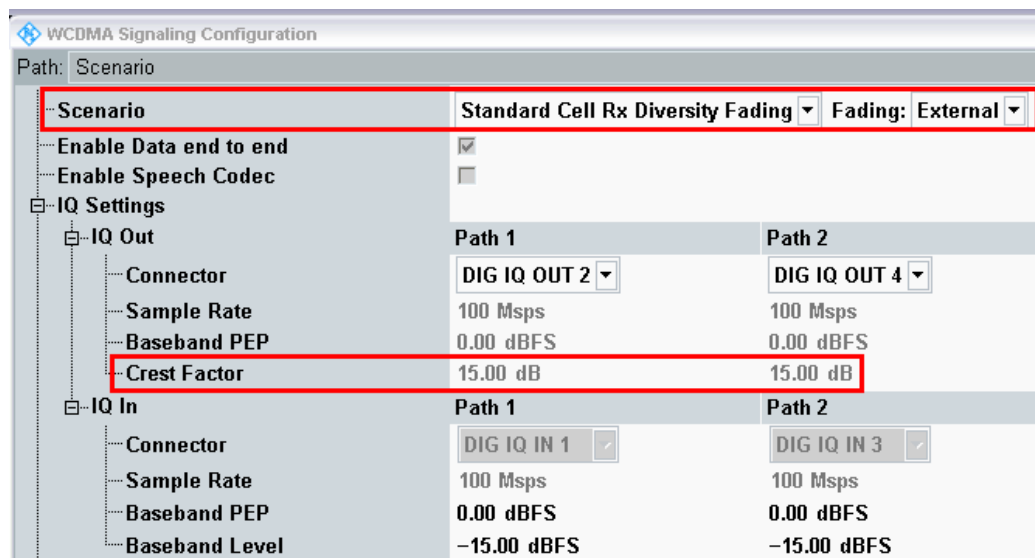

Fig. 4-12: WCDMA scenario for Rx Diversity: Standard Cell Rx Diversity Fading. The CMW indicates the crest factors that are entered in the SMW Dig IQ Input.

Remote commands:

```
// Rx Diversity Fading external
ROUTE:WCDMa:SIGN:SCENario:SCFDiversity
      RF1C,RX1,RF1C,TX1,RF2C,TX2,IQ20,IQ40
// read out IQ Settings
SENSe:WCDMa:SIGN<i>:IQOut:CARRier<carrier>?
```

2. Take note of the **Crest Factors** under **IQ Out** and enter the values in the SMW under **Baseband Input Level** (see Fig. 2-13 in section 2.3).
3. Set a fading for both paths and switch on **I/Q Out** (BBMM1|2)(see section 2.3).
4. In the CMW, enter the corresponding baseband level ( $\text{Level BB}_{\text{out SMW}} = \text{Crest Factor}_{\text{In SMW}} - \text{Insertion Loss}$ ; example:  $-15.0 \text{ dB} - 10 \text{ dB} = -25.0 \text{ dBFS}$ , see 2.3.8), which is indicated by the SMW (see Fig. 4-8). If you add noise to the signal, note the crest factor without noise.
5. Establish a W-CDMA connection between the CMW and DUT, e.g. using **CONNECT HSPA TM**.
6. If you modify the fading, remember to change the level accordingly in the CMW.

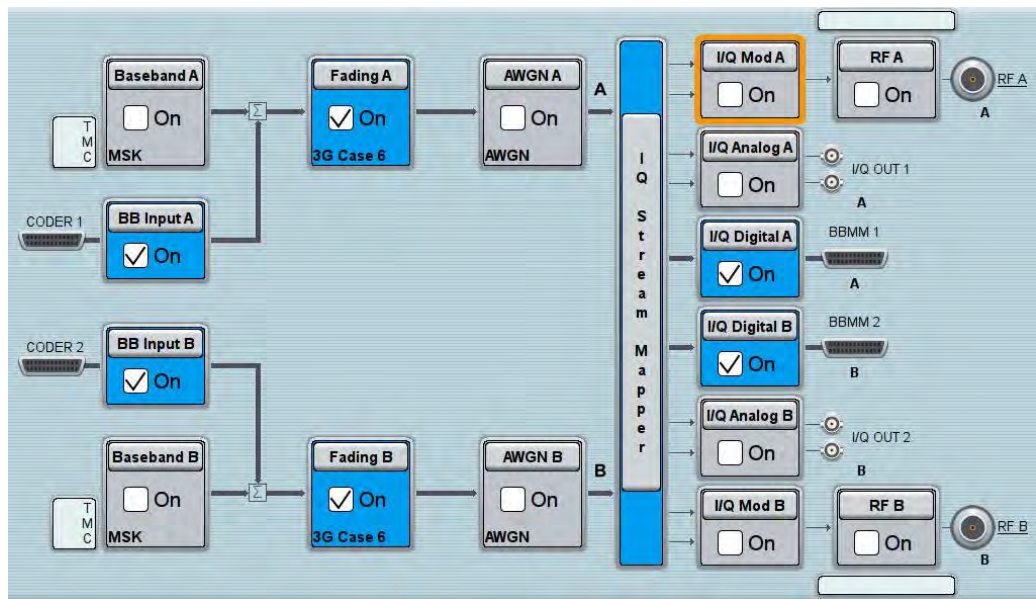

Fig. 4-13: SMW settings for fading two paths.

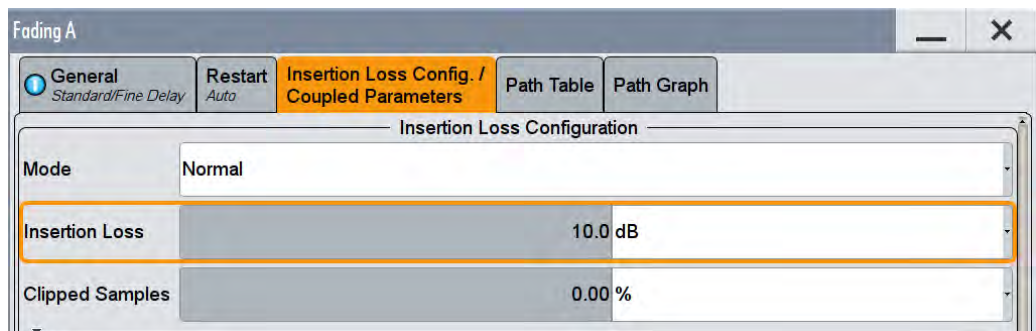

Fig. 4-14: The SMW shows the necessary insertion loss (example: 10 dB)

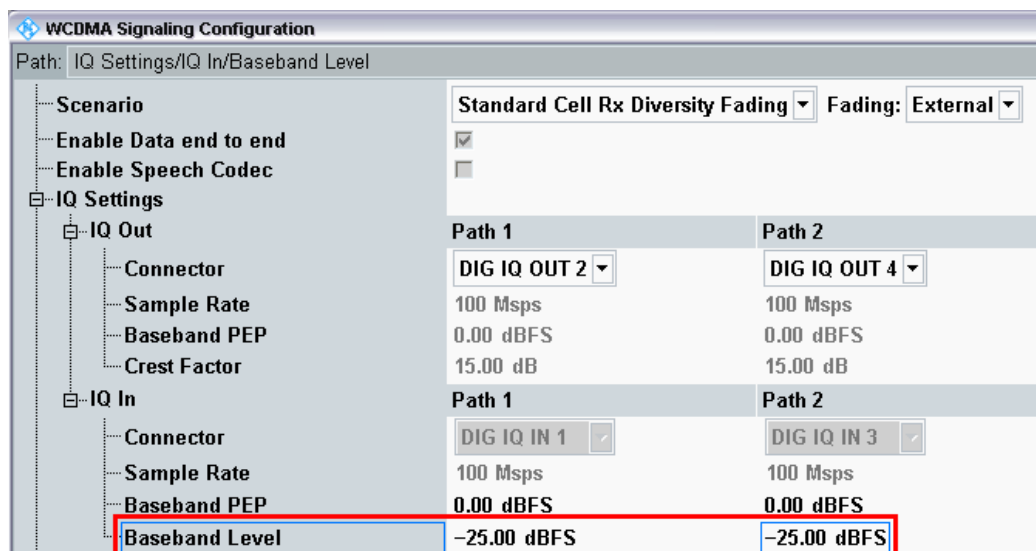

Fig. 4-15: Compensating for the necessary attenuation in the CMW. Here, the levels of the SMW signals are entered as the IQ In level.

Remote command:

```
// set IQ in to PEP 0 dBFS and Level to -25.0 dBFS
CONFigure:WCDMa:SIGN<i>:IQIN:CARRier1 0, -25.0
CONFigure:WCDMa:SIGN<i>:IQIN:CARRier2 0, -25.0
```

7. Start the RX measurement via **WCDMA Rx Meas.** (see section 4.1).

### 4.4 Dual-Carrier Configuration (DC-HSPA+)

With the DC-HSPA+ sceanrio, two different carriers are transmitted via two antennas in order to increase the data throughput. For the simulation, it is necessary to use two fading paths in this case. To enable two downlink carriers, use H-SETs with the suffix A, e.g H-SET 3A.

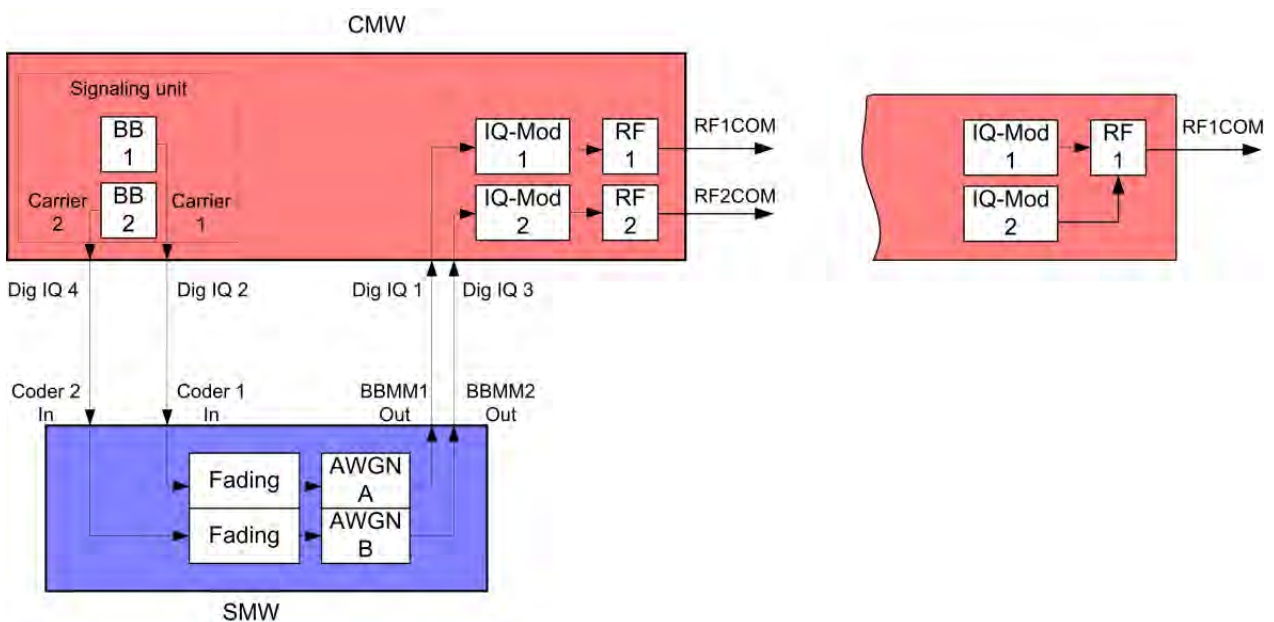

Fig. 4-16: Block diagram for the DC-HSPA test setup. Two carriers are transmitted via two antennas and with different fading. With the CMW, two different RF connectors can be used or the signal can be provided at one output port.

1. In the **WCDMA Signaling Configuration**, select the *Dual Carrier Fading Scenario* (see Fig. 4-18). Set **Fading** to *External*. The CMW can accommodate different antenna configurations for the UE. Output for the second carrier can either be provided through the same RF port or through a separate one.

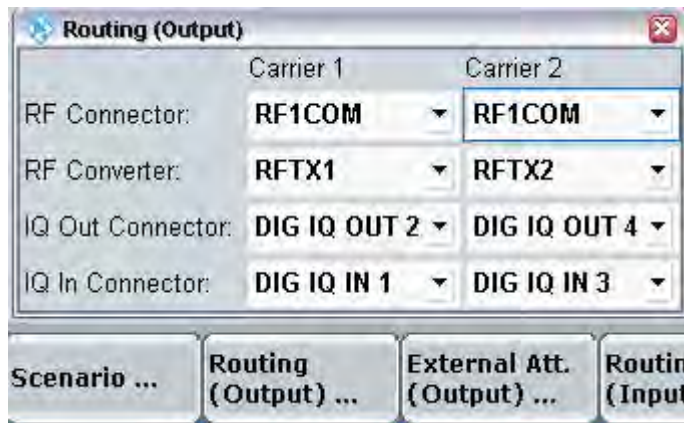

Fig. 4-17: Routing of the signals in the CMW.

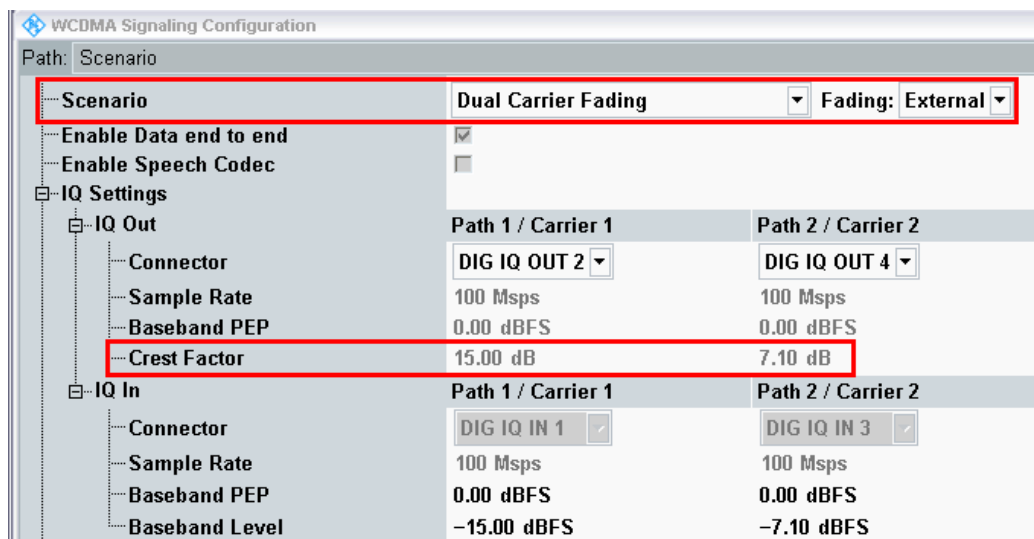

Fig. 4-18: WCDMA scenario for two carriers: Dual-carrier fading. The CMW indicates the crest factors that are entered in the SMW Dig IQ Input.

Remote commands:

```
// Dual Carrier Fading external
ROUTE:WCDMa:SIGN:SCENario:DCFading
                                RF1C,RX1,RF1C,TX1,RF3C,TX2,IQ20,IQ40
// read out IQ Settings
SENSe:WCDMa:SIGN<i>:IQOut:CARRier<carrier>?
```

2. Take note of the **Crest Factors** under **IQ Out** and enter the values in the SMW under **Baseband Input Level** (see Fig. 2-13 in section 2.3).
3. Set a fading for both paths and switch on **I/Q Out (BBMM1|2)**(see section 2.3).
4. In the CMW, enter the corresponding baseband level ( $Level_{BB\ out\ SMW} = Crest\ Factor_{In\ SMW} - Insertion\ Loss$ ; example:  $-15.0\ dB - 10\ dB = -25.0\ dBFS$ , see 2.3.8 ), which is indicated by the SMW (see Fig. 4-8). If you add noise to the signal, note the crest factor without noise.



5. Establish a W-CDMA connection between the CMW and DUT, e.g. using **CONNECT HSPA TM**.
6. If you modify the fading, remember to change the level accordingly in the CMW.

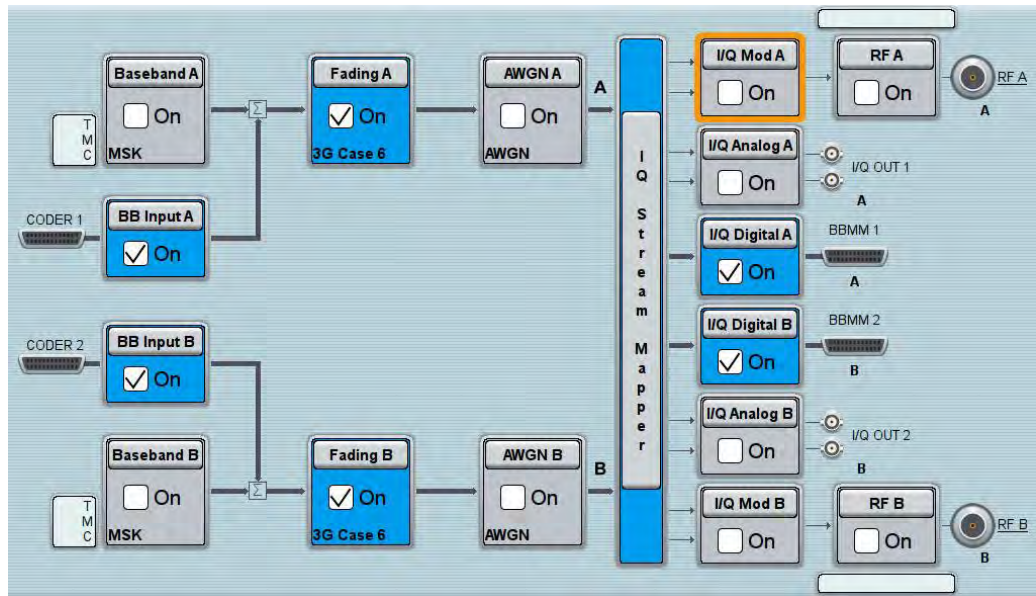

Fig. 4-19: SMW settings for fading two paths.

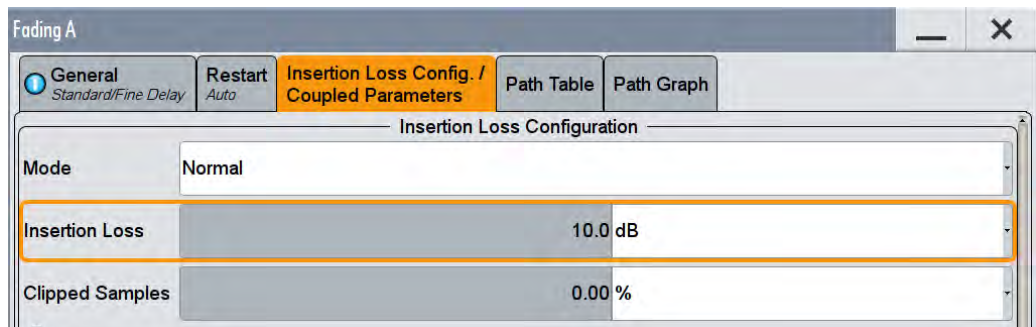

Fig. 4-20: The SMW shows the necessary insertion loss (example: 10 dB)

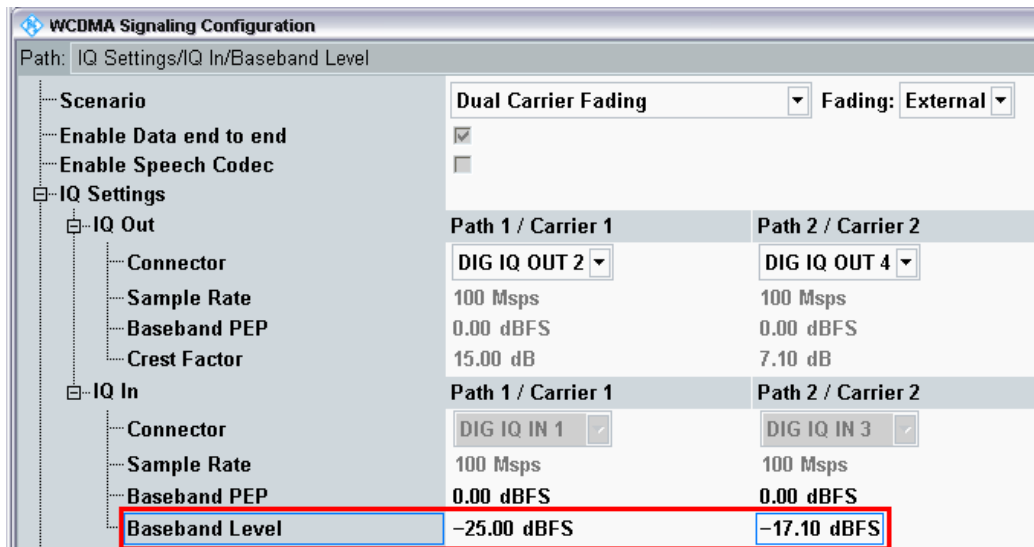

Fig. 4-21: Compensating for the necessary attenuation in the CMW. Here, the levels of the SMW signals are entered as the IQ In level.

Remote command:

```
// set IQ in to PEP 0 dBFS and Level to -25.0 dBFS
CONFigure:WCDMa:SIGN<i>:IQIN:CARRier1 0, -25.0
CONFigure:WCDMa:SIGN<i>:IQIN:CARRier2 0, -17.1
```

- Start the RX measurement via **WCDMA Rx Meas.** (see section 4.1). Fig. 4-22 shows an example of the DC-HSPA measurement in the overview.

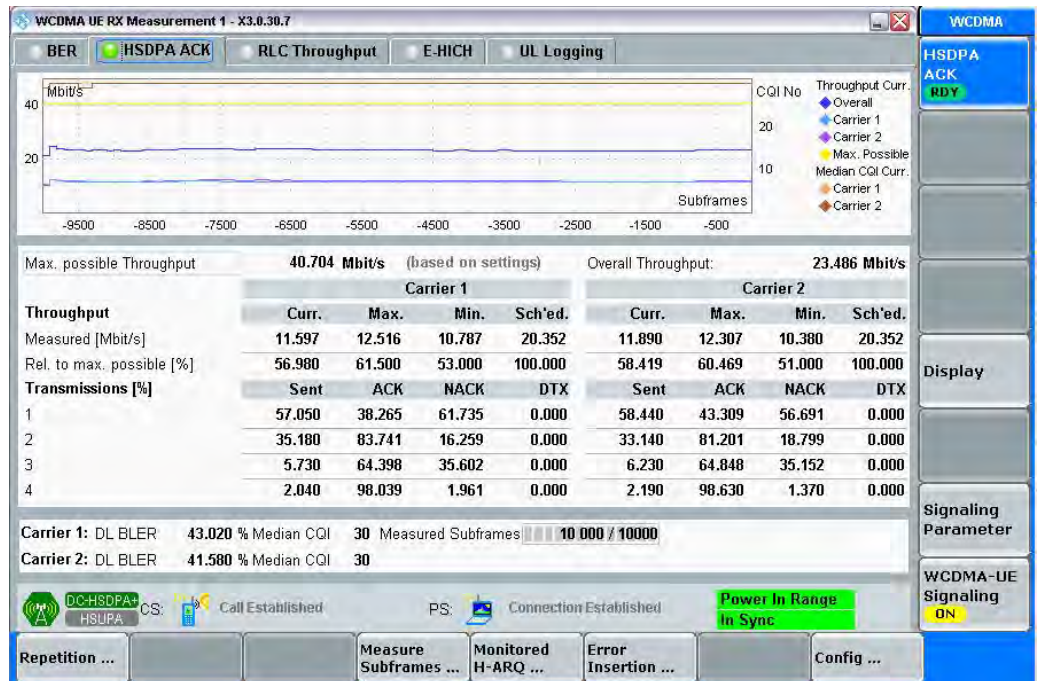

Fig. 4-22: WCDMA RX measurement for DC-HSPA. The measurements are adapted automatically for both streams individually and as an overall assessment.

### 4.5 DC-HSPA+ with Rx Diversity Configuration

With the DC-HSPA+ scenario, two different carriers are transmitted via two antennas in order to increase the data throughput. Here, too, it is possible to simulate the RX diversity reception. Since it is necessary to simulate two carriers for two antennas each, four fading paths are required in this case. The four paths are made available via the SMW's 2x2 MIMO function. However, this is NOT a MIMO function in W-CDMA! To enable two downlink carriers, use H-SETs with the suffix A, e.g H-SET 3A.

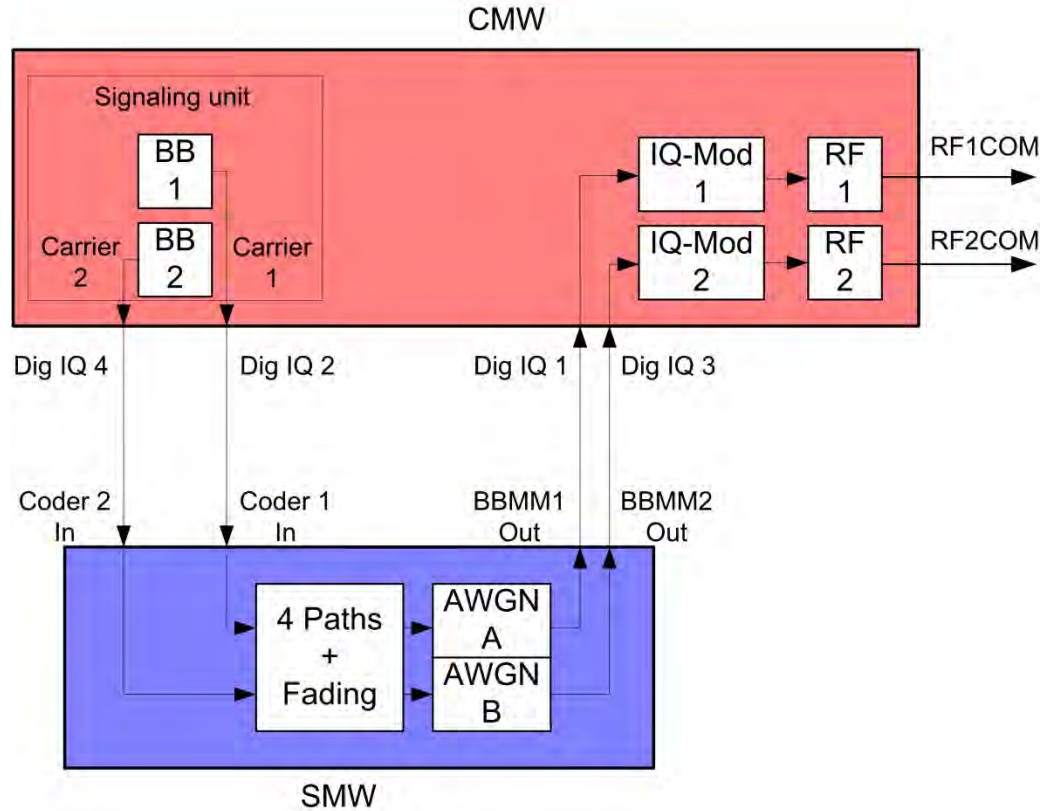

Fig. 4-23: Block diagram for the DC-HSPA test setup with RX diversity. Two carriers are transmitted via two antennas and with different fading. The UE's RX diversity antenna is operated via RF2COM.

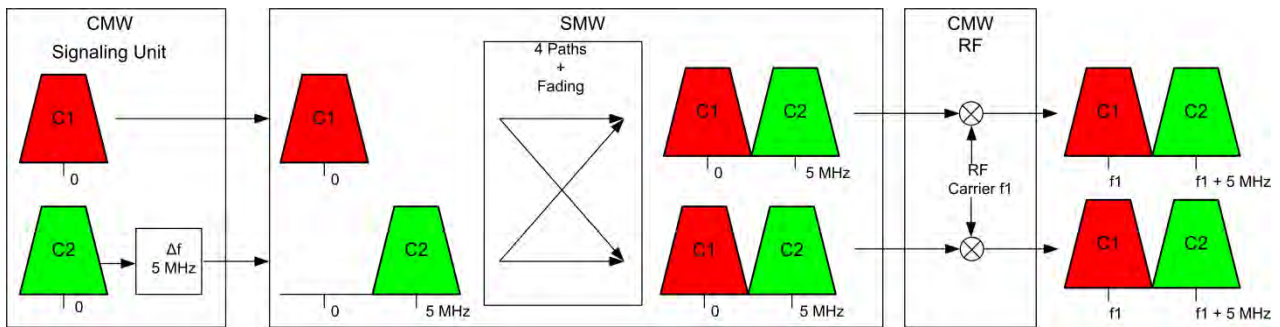

Fig. 4-24: Generating Rx diversity for dual carriers: Both carrier signals are generated in the CMW's baseband signaling unit (with a frequency of 0 Hz), the second signal is offset by 5 MHz in the baseband. Due to the cross components (MIMO function), both carrier signals are available on both of the SMW's paths. In the CMW, both paths are modulated to the carrier frequency f1.

1. In the **WCDMA Signaling Configuration**, select the *Dual Carrier Rx Diversity Fading Scenario* (see Fig. 4-26 ) Set Fading to *External*. For the Rx-diversity reception, a second DUT antenna must be supplied with a signal. To do this, the CMW outputs a signal via a separate RF2COM RF Port.



Fig. 4-25: Routing of the signals in the CMW.

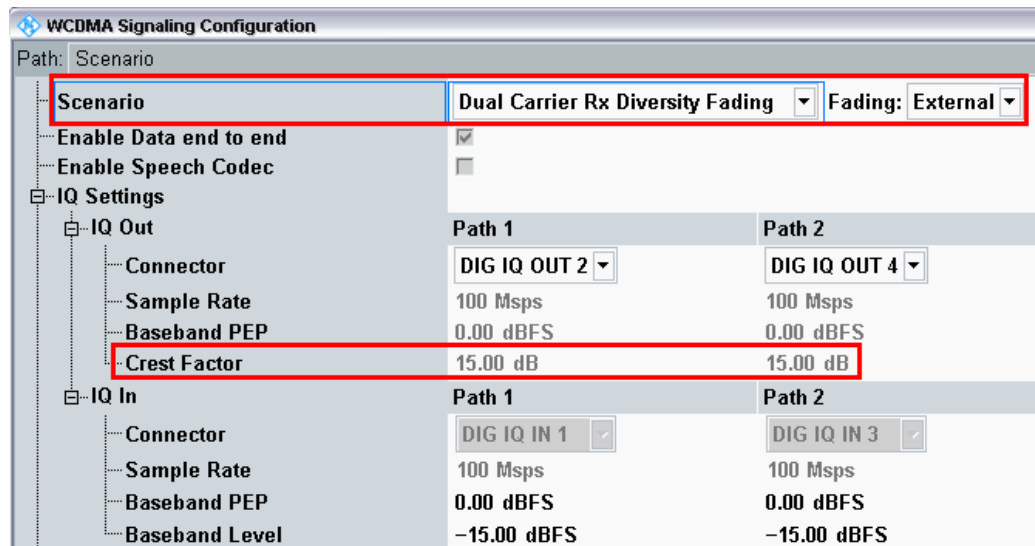

Fig. 4-26: WCDMA scenario for two carriers: Dual carrier fading. The CMW indicates the crest factors that are entered in the AMU Dig IQ inputs.

Remote commands:

```
// Dual Carrier Diversity Fading external
ROUTE:WCDMa:SIGN:SCENario:DCFd
                                RF1C, RX1, RF1C, TX1, RF2C, TX2, IQ2O, IQ4O
// read out IQ Settings
SENSe:WCDMa:SIGN<i>:IQOut:CARRier<carrier>?
```

2. Take note of the **Crest Factors** under **IQ Out** and enter the values in the SMW under **Baseband Input Level** (see Fig. 2-13 in section 2.3).
3. Switch **I/Q Out (BBMM1|2)** on (see section 2.3).

4. The four paths are realized using the SMW's 2x2-MIMO function. In addition, select the fading. This fading value is automatically used for all four paths. Set the virtual RF frequency to the mid-point between the two carriers. (Example: Carrier 1 at 2112.6 MHz and Carrier 2 at 2117.6 MHz -> Virtual frequency at 2115.1 MHz).
5. Set an offset of 5 MHz in the second path.
6. In the CMW, enter the corresponding baseband level (Level  $BB_{out\ SMW} = Crest\ Factor_{In\ SMW} - Insertion\ Loss$ ; example:  $-15.0\ dB - 16\ dB = -31.0\ dBFS$ , see 2.3.8), which is indicated by the SMW (see Fig. 4-8). If you add noise to the signal, note the crest factor without noise.
7. Establish a W-CDMA connection between the CMW and DUT, e.g. using **CONNECT HSPA TM**.
8. If you modify the fading, remember to change the level accordingly in the CMW.

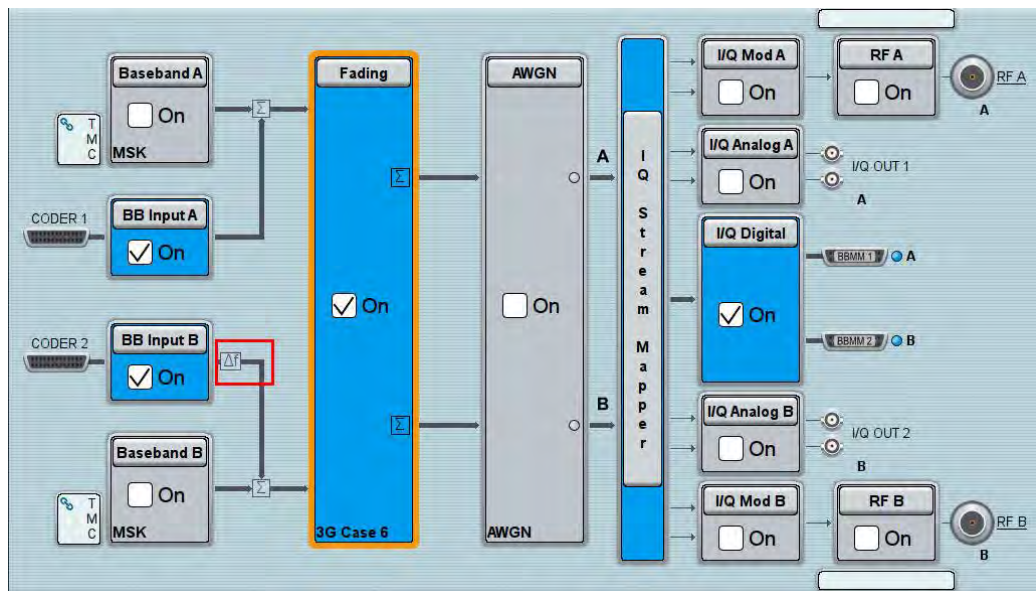

Fig. 4-27: SMW settings for dual carriers for Rx diversity: *Fading of four paths*. The second path must be offset by 5 MHz.

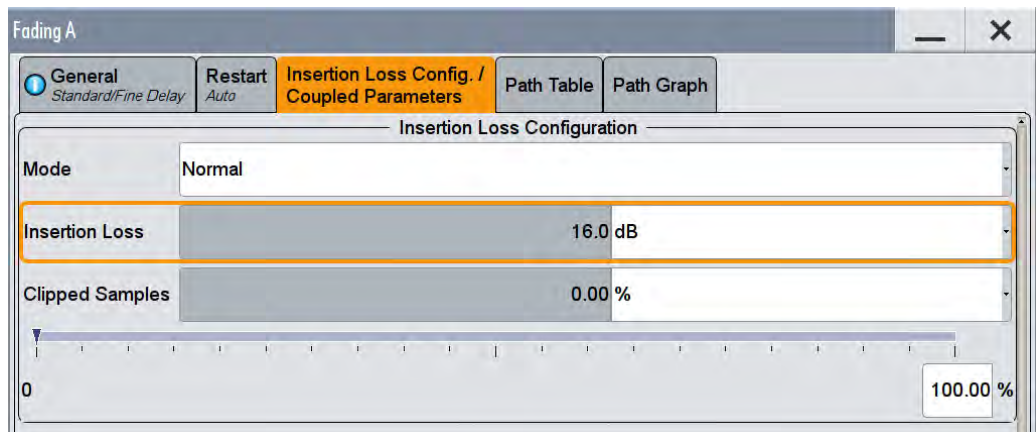

Fig. 4-28: The SMW shows the necessary insertion loss (example: 16 dB)

Remote command:

```
// set IQ in to PEP 0 dBFS and Level to -31.0 dBFS
CONFigure:WCDMa:SIGN<i>:IQIN:CARRier<carrier> 0, -31.0
```

- Use **WCDMA Rx Meas** to start the RX measurement (see section 4.1). Fig. 4-29 shows an example of a DC-HSPA measurement in the overview.



Fig. 4-29: WCDMA RX measurement for DC-HSPA. The measurements are adapted automatically for both streams individually and for the overall assessment.

## 4.6 Dual-Band HSDPA Configuration (DB-DC-HSPA+)

With the Dual-Band-HSDPA configuration, two carriers in two different bands are transmitted via two antennas in order to increase the data throughput. For the simulation, it is necessary to use two fading paths in this case. To enable two downlink carriers, use H-SETs with the suffix A, e.g H-SET 3A.

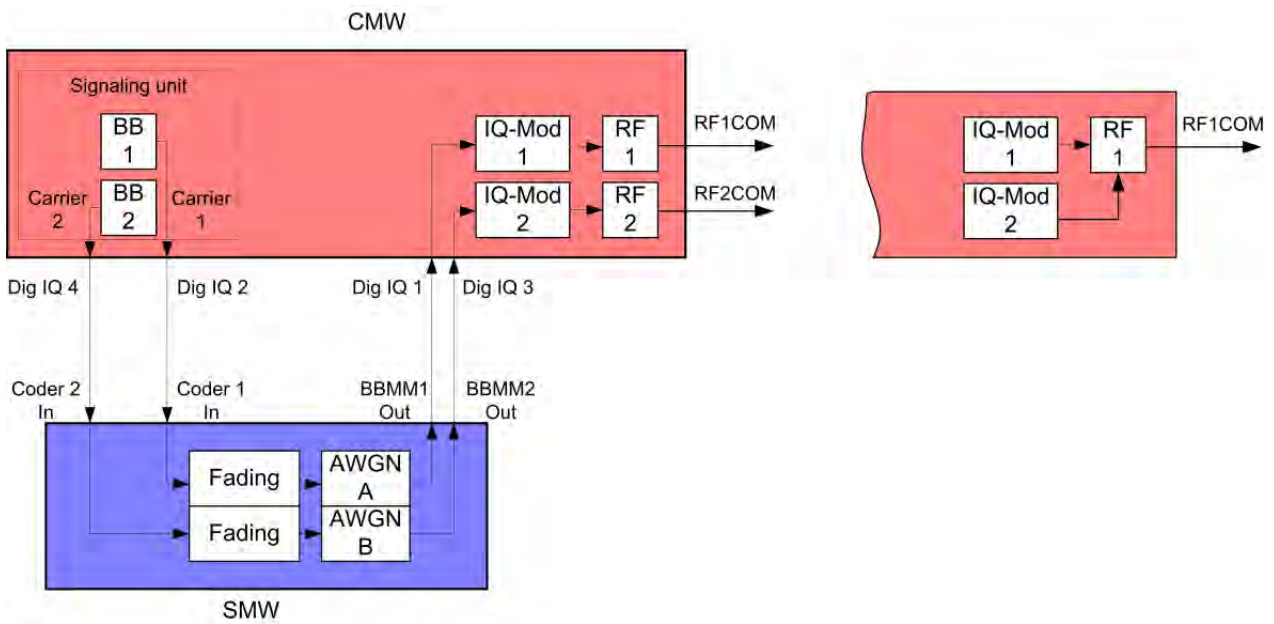

Fig. 4-30: Block diagram for the Dual-Band-HSDPA test setup. Two carriers are transmitted via two antennas and with different fading. With the CMW, two different RF connectors can be used or the signal can be provided at one output port.

1. In the **WCDMA Signaling Configuration**, select the *Dual Carrier / Dual Band Fading Scenario* (see Fig. 4-32). Set **Fading** to *External*. The CMW can accommodate different antenna configurations for the UE. Output for the second carrier can either be provided through the same RF port or through a separate one.

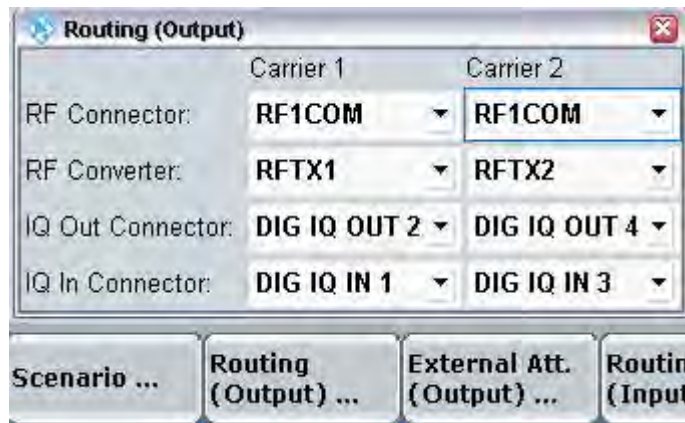

Fig. 4-31: Routing of the signals in the CMW.

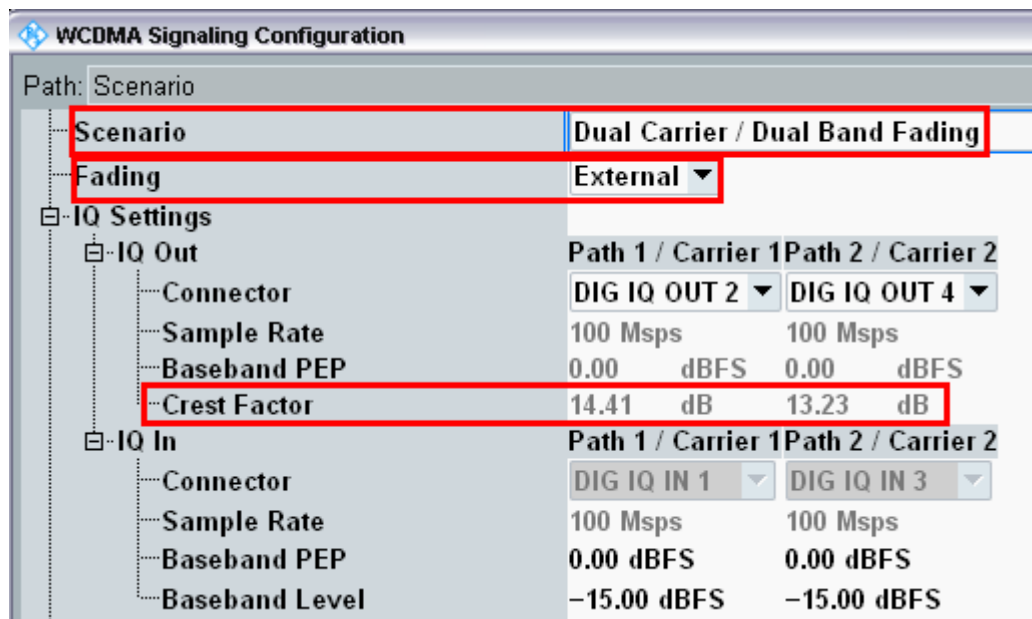

Fig. 4-32: WCDMA scenario for two carriers: Dual-band fading. The CMW indicates the crest factors that are entered in the SMW Dig IQ Input.

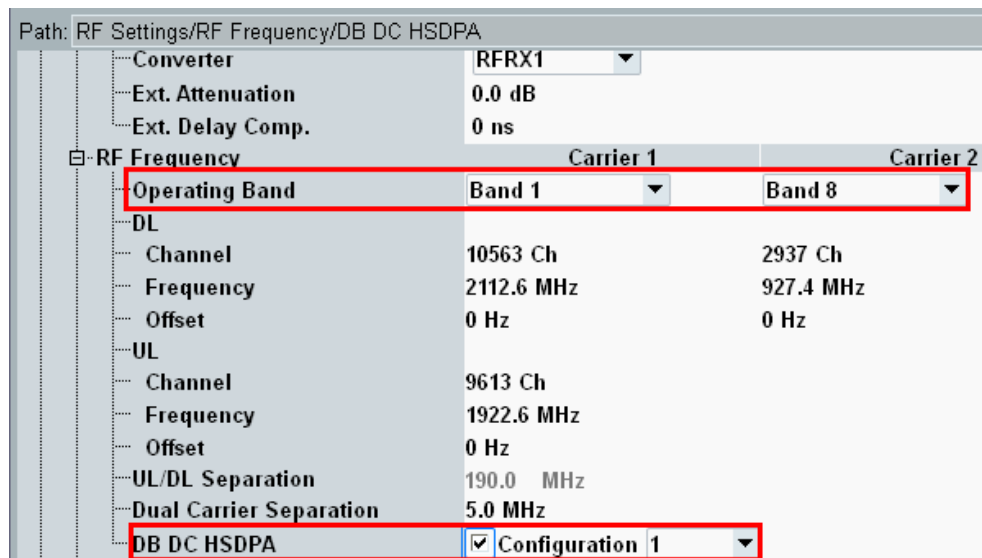

Fig. 4-33: Enabling the Dual Band Configuration. The CMW sets the corresponding operating bands automatically.

Remote commands:

```
// Dual Band Fading external
ROUTE:WCDMa:SIGN:SCENario:DBFading
                                RF1C,RX1,RF1C,TX1,RF3C,TX2,IQ20,IQ40

// read out IQ Settings
SENSe:WCDMa:SIGN<i>:IQOut:CARRier<carrier>?

// enable Dual band HSDPA with Configuration 1
CONFigure:WCDMa:SIGN<i>:RFSettings:DBDC ON,C1
```



2. Take note of the **Crest Factors** under **IQ Out** and enter the values in the SMW under **Baseband Input Level** (see Fig. 2-13 in section 2.3).
3. Set a fading for both paths and switch on **I/Q Out (BBMM1|2)**(see section 2.3).
4. In the CMW, enter the corresponding baseband level (Level  $BB_{out\ SMW} = Crest\ Factor_{In\ SMW} - Insertion\ Loss$ ; example:  $-14.41\ dB - 10\ dB = -24.41\ dBFS$ , see 2.3.8 ), which is indicated by the SMW (see Fig. 4-8). If you add noise to the signal, note the crest factor without noise.
5. Establish a W-CDMA connection between the CMW and DUT, e.g. using **CONNECT HSPA TM**.
6. If you modify the fading, remember to change the level accordingly in the CMW.

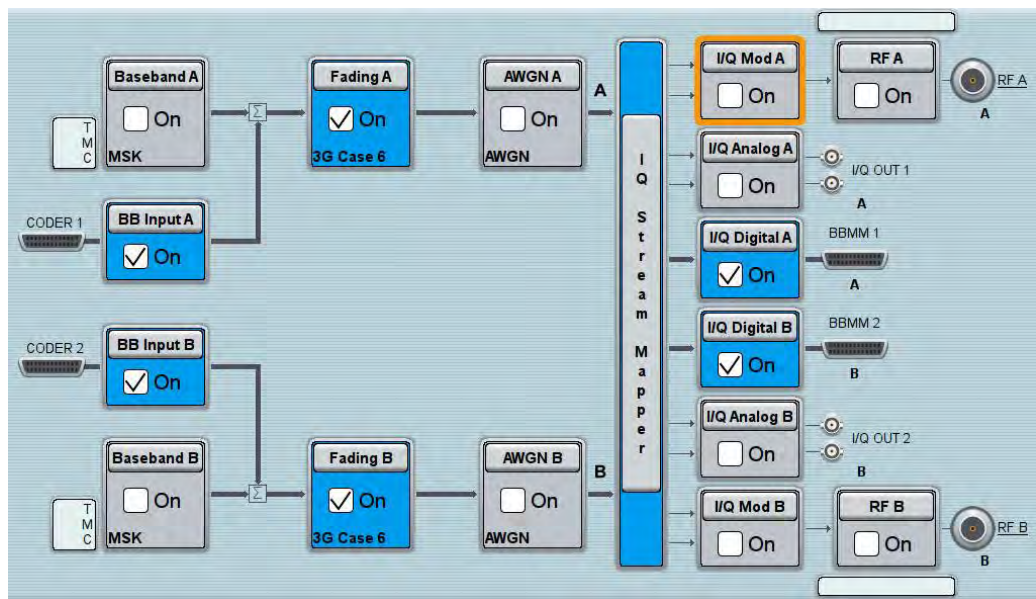

Fig. 4-34: SMW settings for fading two paths.

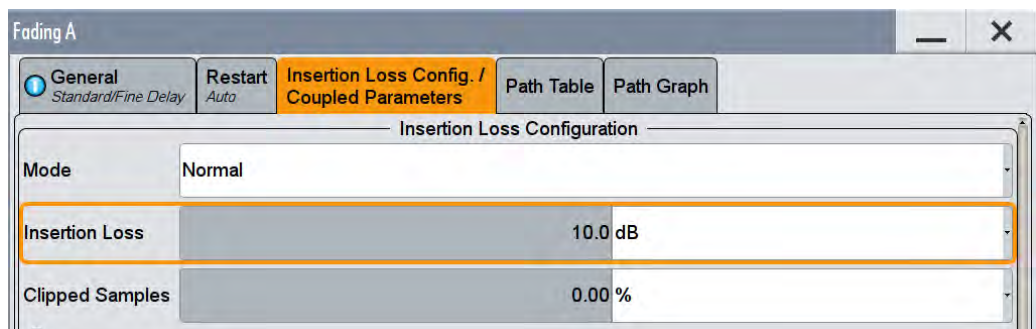

Fig. 4-35: The SMW shows the necessary insertion loss (example: 10 dB)

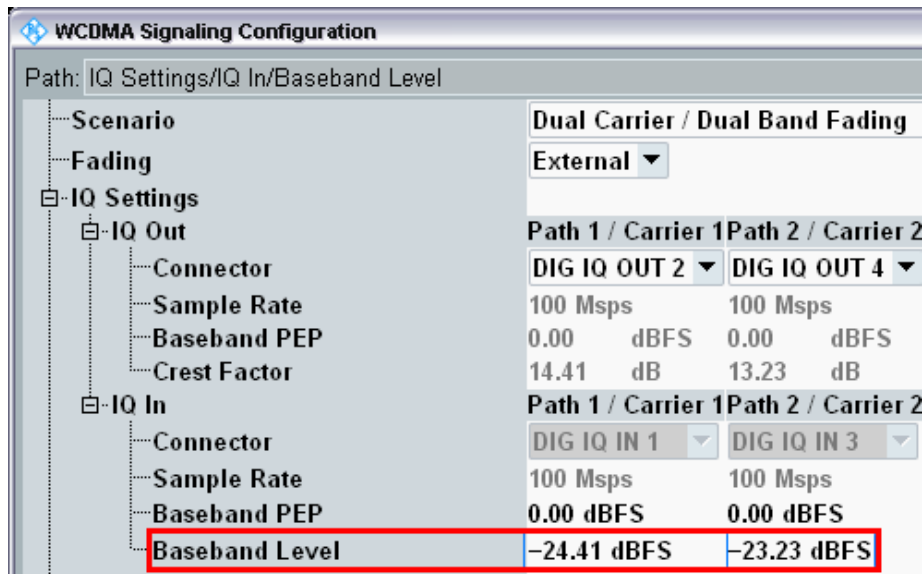

Fig. 4-36: Compensating for the necessary attenuation in the CMW. Here, the levels of the SMW signals are entered as the IQ In level.

Remote command:

```
// set IQ in to PEP 0 dBFS and Level to -24.41 dBFS
CONFigure:WCDMa:SIGN<i>:IQIN:CARRier1 0, -24.41
CONFigure:WCDMa:SIGN<i>:IQIN:CARRier2 0, -23.23
```

- Start the RX measurement via **WCDMA Rx Meas.** (see section 4.1). Fig. 4-22 shows an example of the Dual-Band HSPSA measurement in the overview.

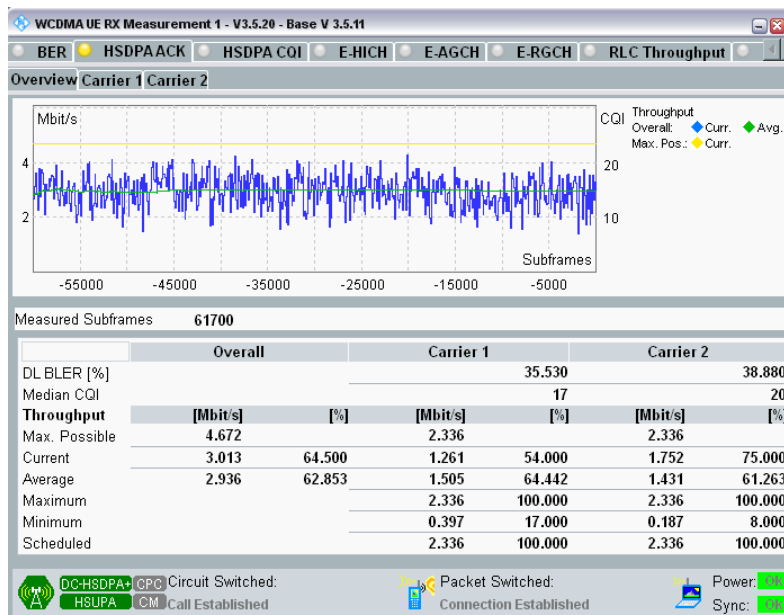

Fig. 4-37: WCDMA RX measurement for Dual-Band-HSPDA. The measurements are adapted automatically for both streams individually and as an overall assessment.

### 4.7 Dual Band HSDPA with Rx Diversity Configuration (DB-DC-HSPA+ with Rx Diversity)

With the Dual-Band HSDPA configuration, two different carriers are transmitted via two antennas in order to increase the data throughput. Here, too, it is possible to simulate the RX diversity reception. Since it is necessary to simulate two carriers for two antennas each, four fading paths are required in this case. The four paths are faded in the SMW. To enable two downlink carriers, use H-SETs with the suffix A, e.g H-SET 3A.

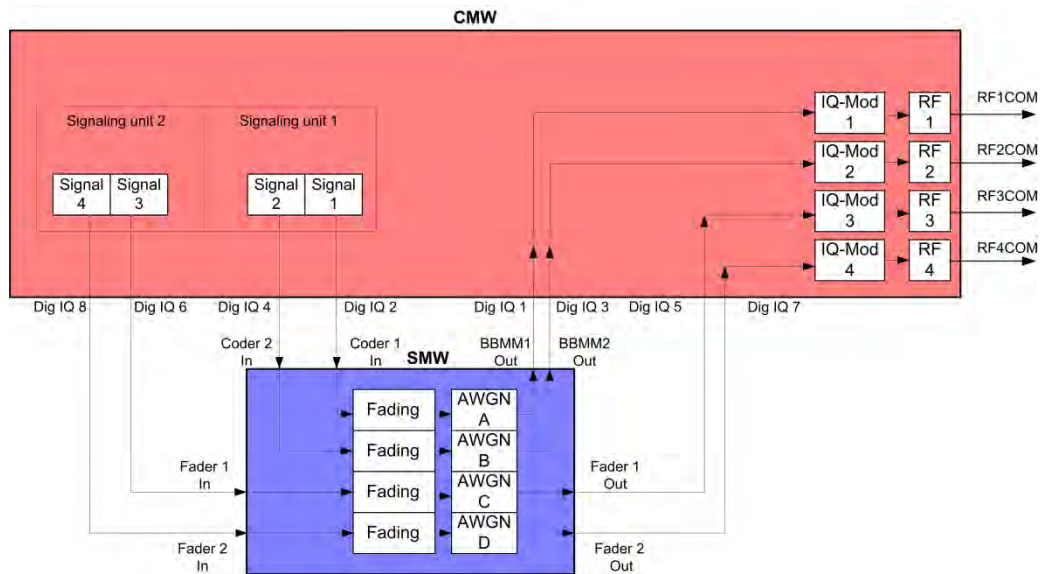

Fig. 4-38: Block diagram for the Dual-Band-HSDPA test setup with RX diversity. Two carriers are transmitted via two antennas and with different fading. The UE's RX diversity antenna is operated via RF2COM.

1. In the **WCDMA Signaling Configuration**, select the *Dual Carrier / Dual Band Rx Diversity Fading Scenario* (see Fig. 4-40) Set Fading to *External*. For the Rx-diversity reception, a second DUT antenna must be supplied with the two carrier signals. To do this, the CMW allows flexible output routing.

Routing (Output)				
	Path 1	Path 2	Path 3	Path 4
RF Connector:	RF1COM	RF2COM	RF3COM	RF4COM
RF Converter:	RFTX1	RFTX3	RFTX2	RFTX4
IQ Out Connector:	DIG IQ OUT 2	DIG IQ OUT 4	DIG IQ OUT 6	DIG IQ OUT 8
IQ In Connector:	DIG IQ IN 1	DIG IQ IN 3	DIG IQ IN 5	DIG IQ IN 7

Fig. 4-39: Routing of the signals in the CMW. In this case, RxDiv signal of carrier 1 is routed to RF3COM, RxDiv signal of carrier 2 is routed to RF4COM.

Dual Band HSDPA with Rx Diversity Configuration (DB-DC-HSPA+ with Rx Diversity)

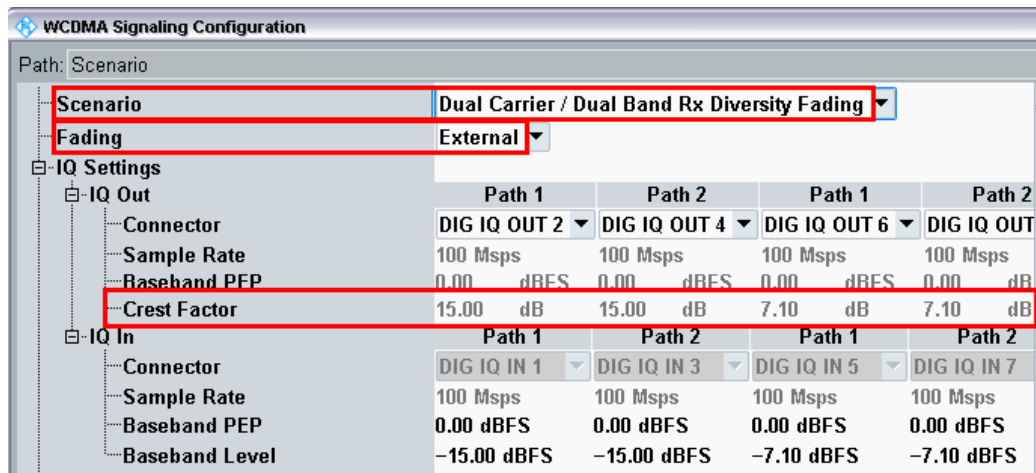

Fig. 4-40: WCDMA scenario for two carriers: Dual Band fading. The CMW indicates the crest factors that are entered in the SMW Dig IQ inputs.

Remote commands:

```
// Dual Band Diversity Fading external
ROUTE:WCDMa:SIGN:SCENario:DBFDiversity
    RF1C, RX1, RF1C, TX1, RF3C, TX2,
    RF2C, RX3, RF2C, TX3, RF4C, TX4,
    IQ20, IQ60, IQ40, IQ80

// read out IQ Settings
SENSe:WCDMa:SIGN<i>:IQOut:CARRier<carrier>?
```

2. Take note of the **Crest Factors** under **IQ Out** and enter the values in the SMW under **Baseband Input Level** (see Fig. 2-13 in section 2.3).
3. Switch **I/Q Out (BBMM1|2|FADER1|2)** on (see section 2.3).
4. The four downlink paths are individually faded in the SMW. Set in the **System Configuration** Advanced mode a **4 x 1 x 1** configuration (Fig. 4-41 and Fig. 4-42).
5. In the CMW, enter the corresponding baseband level for all four paths (Level  $BB_{out\ SMW} = Crest\ Factor_{In\ SMW} - Insertion\ Loss$ ; example:  $-15.0\ dB - 10\ dB = -25.0\ dBFS$ , see 2.3.8), which is indicated by the SMW (see Fig. 4-8). If you add noise to the signal, note the crest factor without noise.
6. Establish a W-CDMA connection between the CMW and DUT, e.g. using **CONNECT HSPA TM**.
7. If you modify the fading, remember to change the level accordingly in the CMW.

Dual Band HSDPA with Rx Diversity Configuration (DB-DC-HSPA+ with Rx Diversity)

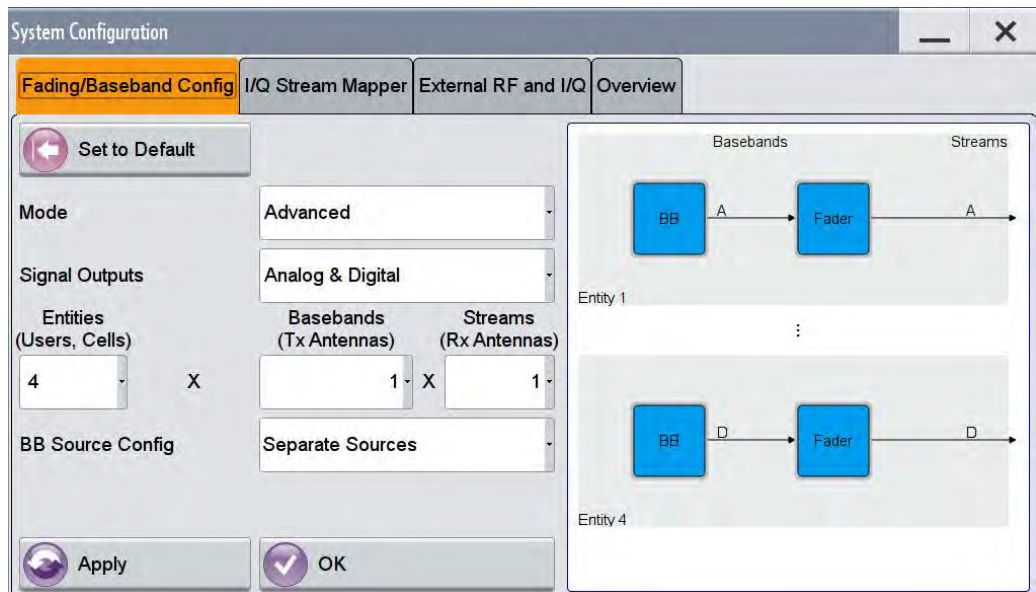

Fig. 4-41: Use 4 entities to enable 4 separated fading paths ( 4 x 1 x 1).

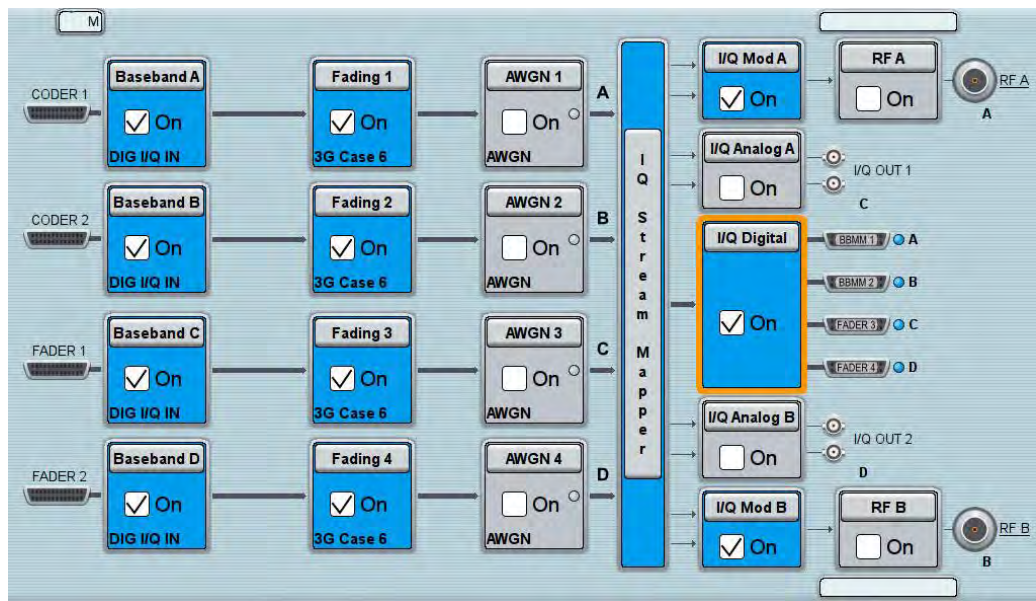

Fig. 4-42: SMW settings for dual band for Rx diversity: Fading of four paths.

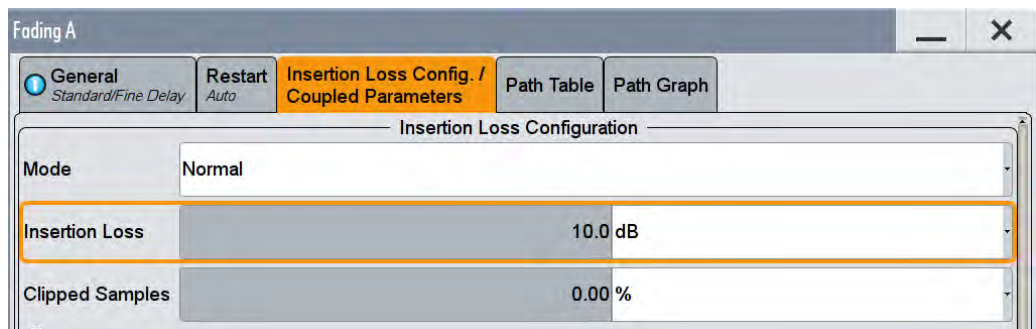

Fig. 4-43: The SMW shows the necessary insertion loss (example: 10 dB)

Remote command:

```
// set IQ in to PEP 0 dBFS and Level to -25.0 dBFS
CONFigure:WCDMa:SIGN<i>:IQIN:CARRier<carrier> 0, -25.0
```

- Use **WCDMA Rx Meas** to start the RX measurement (see section 4.1). Fig. 4-29 shows an example of a DC-HSPA measurement in the overview.

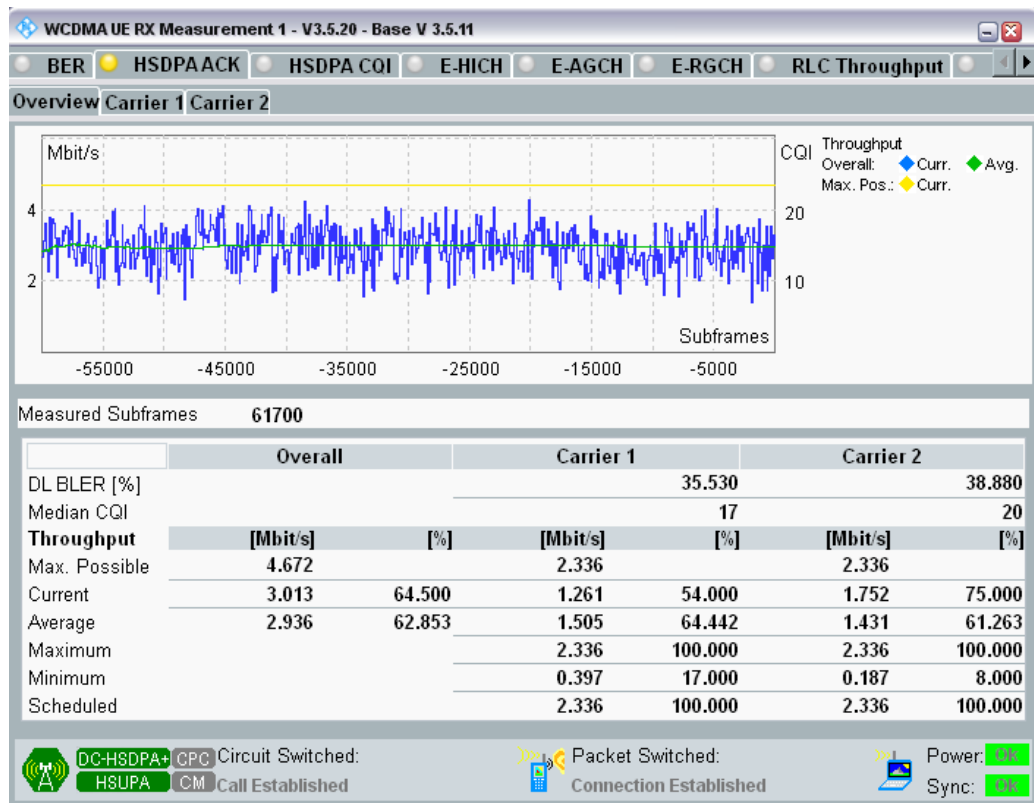

Fig. 4-44: WCDMA RX measurement for Dual-Band HSDPA. The measurements are adapted automatically for both streams individually and for the overall assessment.

## 4.8 CMW Internal Fading for W-CDMA and HSPA(+)

For all of the above Fading scenarios (see also Table 4-1):

- Standard cell fading
- Standard cell Rx Diversity fading
- Dual Carrier Fading
- Dual Carrier Rx Diversity Fading

- Dual Carrier / Dual Band Fading
- Dual Carrier / Dual Band Rx Diversity Fading

the internal fading in the CMW can be used with the software option CMW-KE400. It allows the predefined fading settings (3GPP TS 25.101, Annex B.2.):

- Multi-path profiles
  - Case 1 to 6
  - ITU pedestrian A/B with 3 km/h (PA3, PB3)
  - ITU vehicular A with 3 km/h, 30 km/h, 120 km/h (VA3, VA30, VA120)
- Moving propagation
- High speed train profile (HST)
- Birth-death propagation

1. Set the wanted **Scenario** and set **Fading** to *Internal*.

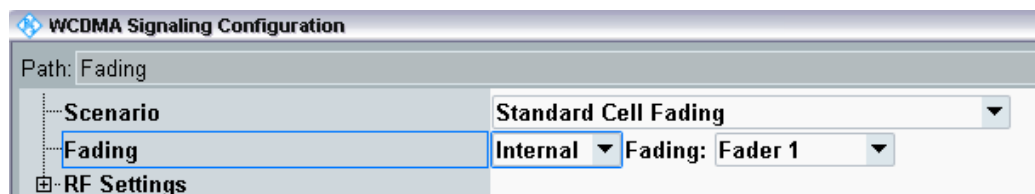

Fig. 4-45: WCDMA scenario with internal fading

Remote commands:

```
// Standard Cell Fading internal
ROUTE:WCDMa:SIGN:SCENario:SCFading:INTernal RF1C,RX1,RF1C,TX1
// Rx Diversity Fading internal
ROUTE:WCDMa:SIGN:SCENario:SCFDiversity:INTernal
    RF1C,RX1,RF1C,TX1,RF2C,TX2
// Dual Carrier Fading internal
ROUTE:WCDMa:SIGN:SCENario:DCFading:INTernal
    RF1C,RX1,RF1C,TX1,RF3C,TX2
// Dual Carrier Diversity Fading internal
ROUTE:WCDMa:SIGN:SCENario:DCF Diversity:INTernal
    RF1C,RX1,RF1C,TX1,RF2C,TX2

// Dual Band Fading internal
ROUTE:WCDMa:SIGN:SCENario:DBFading:INTernal
    RF1C,RX1,RF1C,TX1,RF3C,TX2
// Dual Band Diversity Fading internal
ROUTE:WCDMa:SIGN:SCENario:DBFDiversity:INTernal
    RF1C,RX1,RF1C,TX1,RF3C,TX2,
    RF2C,TX3,RF4C,TX4,
```

2. Select under **Fading Simulator** the wanted *Profile* (example Case 1)

3. Enable the Fading

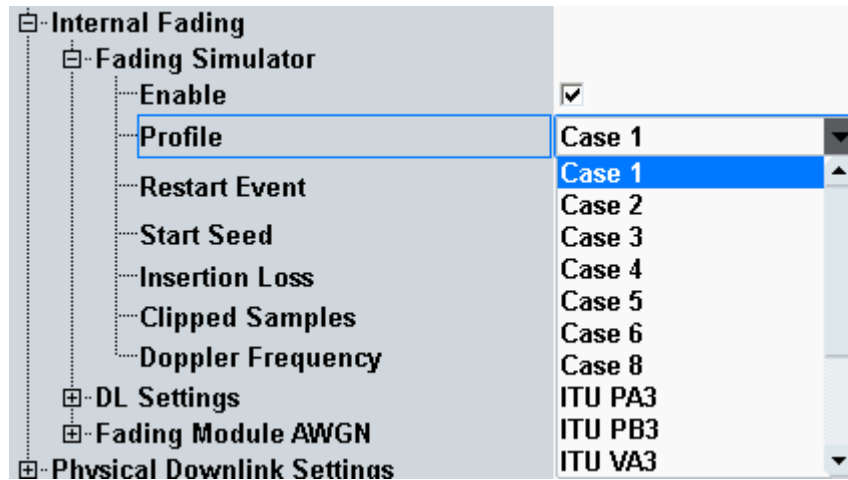

Fig. 4-46: internal W-CDMA fading profiles

Remote commands:

```
// Fading profile Case1
CONFigure:WCDMa:SIGN<i>:FADing:FSIMulator:STANdard C1
// Switch on FADing
CONFigure:WCDMa:SIGN<i>:FADing:FSIMulator:ENABle ON
```

4. If wanted, apply AWGN by setting the Noise and enable the AWGN.

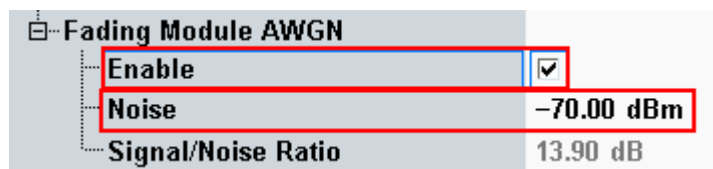

Fig. 4-47: internal W-CDMA AWGN section

Remote commands:

```
// Noise - 70 dBm
CONFigure:WCDMa:SIGN<i>:FADing:CARRier<c>:AWGN:NOISe - 70 dbm
// Switch on AWGN
CONFigure:WCDMa:SIGN<i>:FADing:CARRier<c>:AWGN:ENABle ON
```

5. Start the measurement (see 4.1).



## 5 GSM and (E)GPRS(2) Measurements

The original GSM standard has been developed in several releases to support higher data rates and increase capacity:

Landmarks in GSM evolution		
Release	Name	Feature
Early 1990's	GSM	Circuit switched voice calls
97	GPRS	Packet switched data calls Multi slot
98	EDGE	8PSK modulation
07	EDGE evolution	Higher order modulations (16QAM and 32QAM) DL Dual carrier Optional: increased symbol rate
09	VAMOS	Double voice capacity with AQPSK modulation

Table 5-1: GSM evolution: All features before Rel. 07 are available in one option for the CMW called Rel. 6.

The MS receiver measurements include different types of measurements depending on the type of connection:

- Circuit Switched connections (CS)

For circuit switched connections the CS BER is available.

GSM circuit switched BER					
CS BER (measure mode)	Traffic Mode			Measurement on	Test Loop
	Full rate (FR Vx)	Half Rate (HR)	AMR		
Burst by Burst	<input checked="" type="checkbox"/>	<input checked="" type="checkbox"/>	<input checked="" type="checkbox"/>	Burst	C
BER	<input checked="" type="checkbox"/>	<input checked="" type="checkbox"/>	<input checked="" type="checkbox"/>	Speech frame	B
RBER/FER	<input checked="" type="checkbox"/>	<input checked="" type="checkbox"/>	<input checked="" type="checkbox"/>	Speech frame	A
FER FACCH	<input checked="" type="checkbox"/>	<input checked="" type="checkbox"/>	<input checked="" type="checkbox"/>	Frame	-
FER SACCH	<input checked="" type="checkbox"/>	<input checked="" type="checkbox"/>	<input checked="" type="checkbox"/>	Blocks	-
RBER/UFR		<input checked="" type="checkbox"/>		Speech frame	D
AMR Inband FER			<input checked="" type="checkbox"/>	Speech frame	I
Mean BEP <sup>1</sup>	<input checked="" type="checkbox"/>	<input checked="" type="checkbox"/>	<input checked="" type="checkbox"/>	Burst	C
Signal Quality <sup>1</sup>	<input checked="" type="checkbox"/>	<input checked="" type="checkbox"/>	<input checked="" type="checkbox"/>	Burst	-

Table 5-2: Different measure modes in CS BER. Note 1: Mean BEP and Signal Quality need different settings of the enhanced measurement report, thus exclude each other.

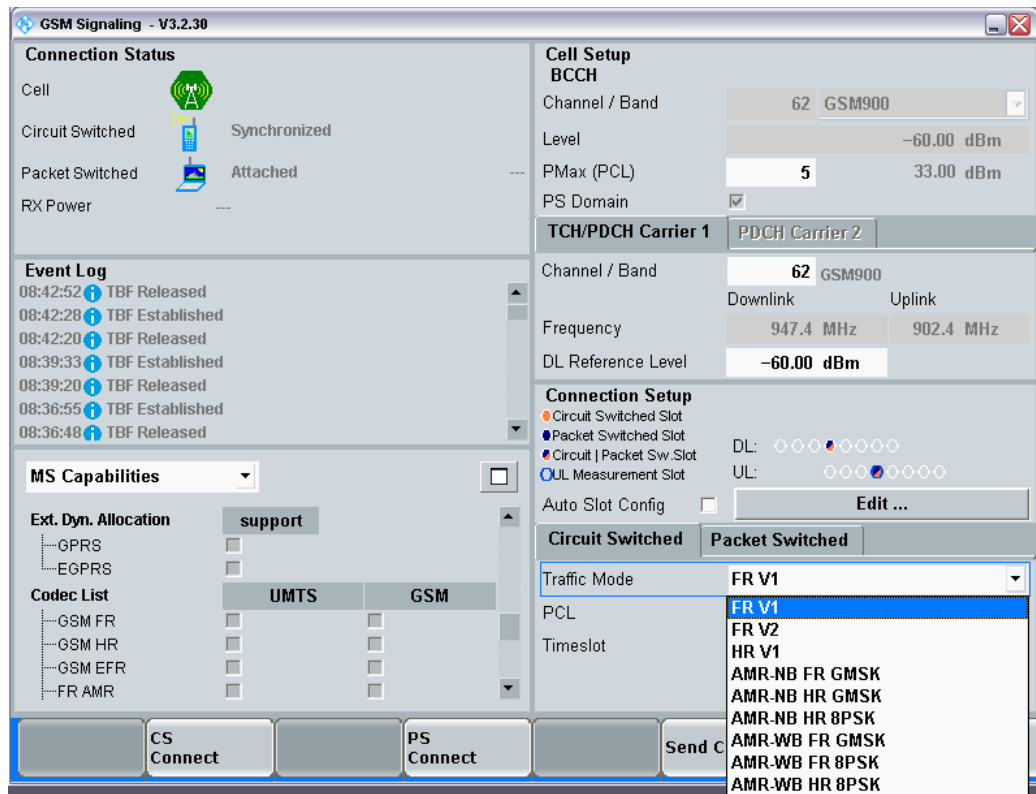

Fig. 5-1: Traffic modes in circuit switched GSM connections

Remote commands:

```
// Traffic Mode Full rate version 1
CONFIGure:GSM:SIGN<i>:CONNECTION:CSWitched:TMODE FV1
// Test Loop B
CONFIGure:GSM:SIGN<i>:CONNECTION:CSWitched:LOOP B
// connect in circuit switched
CALL:GSM:SIGN<i>:CSWitched:ACT CONNECT
```

Packet Switched connections (PS)

For packet switched connections three different measurements are available.

GSM Rx measurements packet switched					
Rx Measurement	Service (Test mode)				Comment
	A	B	BLER	SRB	
PS BER	☑	☑		☑	
BLER			☑		
RLC Throughput	☑	☑	☑	☑	And with DAU

Table 5-3: The packet switched measurements possibilities depend on the test modes.

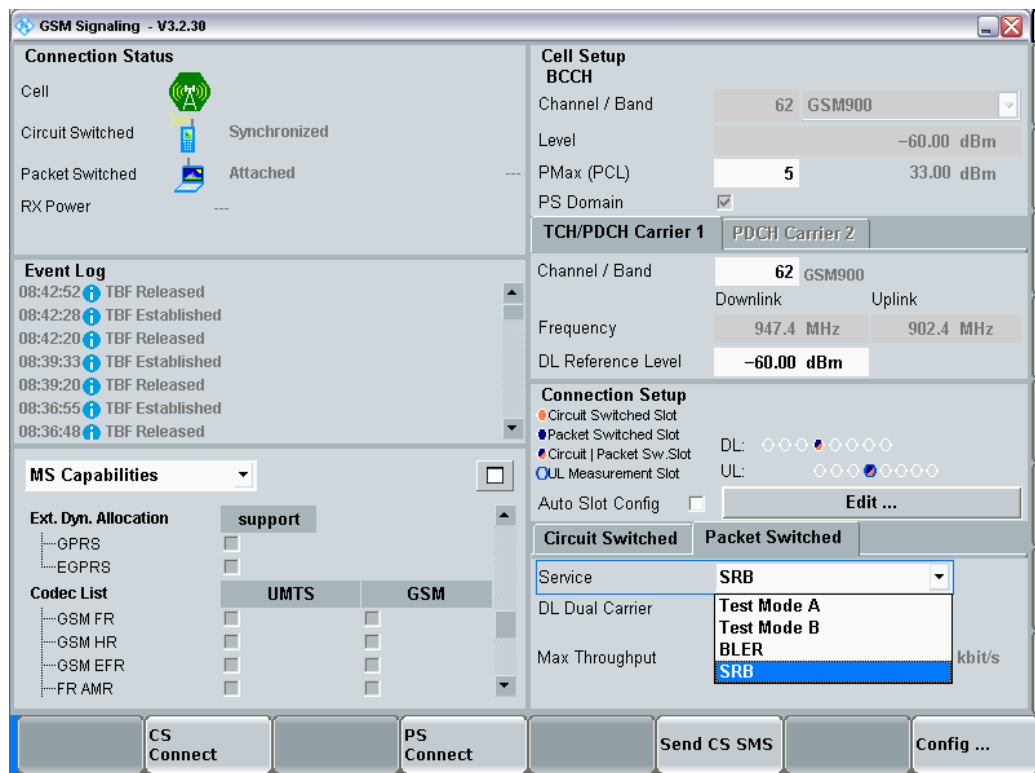

Fig. 5-2: Services in packet switched GSM connections

Remote commands:

```
// Service BLER
CONFigure:GSM:SIGN<i>:CONNECTION:PSWitched:SERVICE BLER
// connect in packet switched
CALL:GSM:SIGN<i>:PSWitched:ACT CONNECT
```

**Auto Slot Configuration: Wizard**

To simplify the multi slot settings, the CMW offers the **Auto Slot Configuration** wizard. It reads the Multislot class information which the MS transmits during the synchronization/attaching process to the CMW and sets the multi slot configuration automatically according to the selected service.

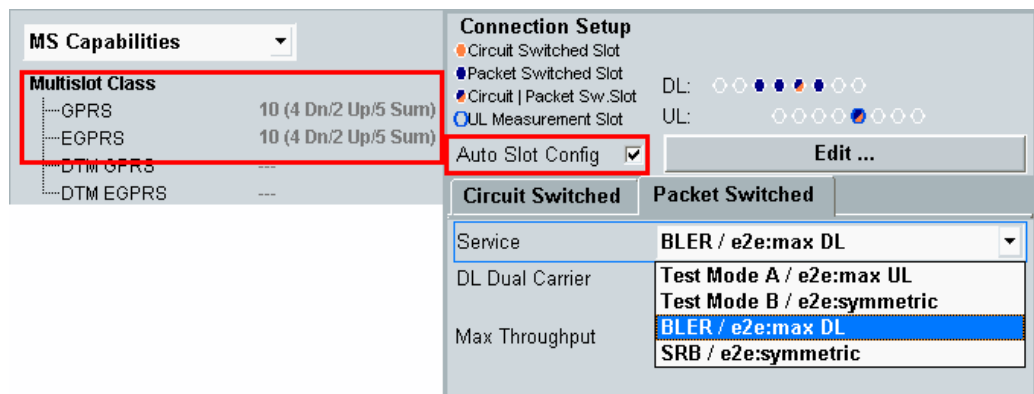

Fig. 5-3: Auto Slot Configuration (in the example the MS supports 4 DL slots and 2 UL slots and in sum 5 slots. With the selected service BLER it set the maximum possible slots in the DL: 4 slots)

Remote command:

```
// use auto slot configuration
CONFigure:GSM:SIGN<i>:CONNECTION:ASConfig ON
```

### Measurements

All measurements are summarized in the **GSM RX Meas** test and measurement applications (see 5.1).

Before the start of the GSM signaling, external fading must be selected as the scenario. Once signaling has begun, or once a connection has been established with the DUT, it is no longer possible to change scenarios.

For further information on GSM signaling and Rx measurements, refer to [9].

## 5.1 Mobile Station Receiver Measurement in GSM: Rx Meas

### CS BER

This measurement calculates bit error rates in circuit switched connections. Typically the CMW transmits data which are looped back by the DUT. Different measure modes are available (see 5.1, detailed information is available in [9]).

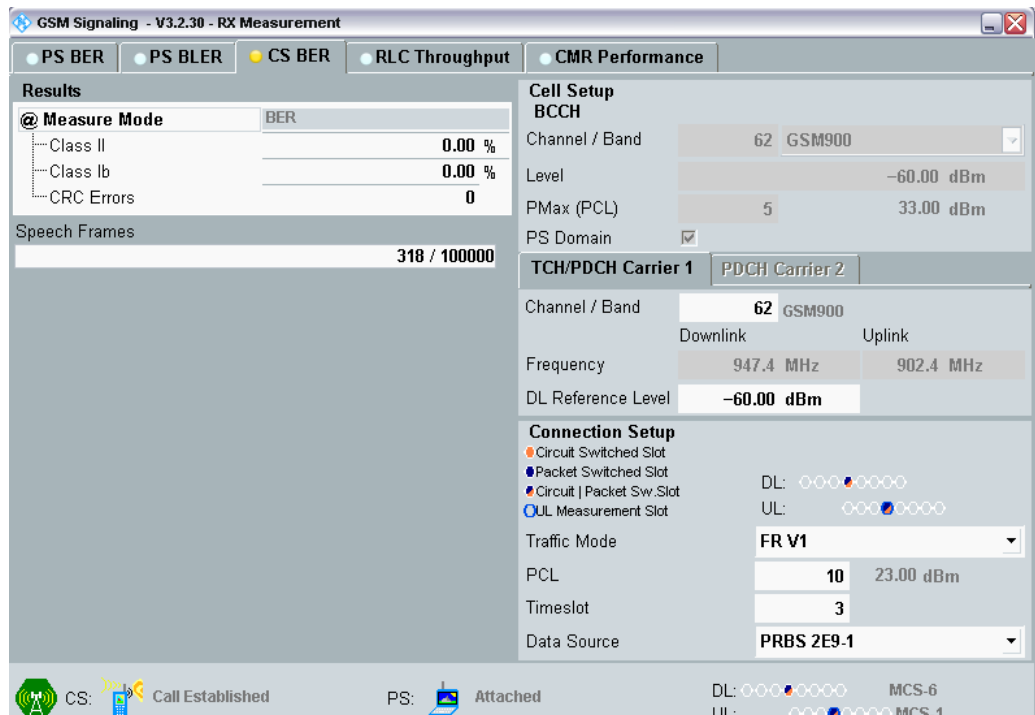

Fig. 5-4: Example for CS BER in GSM: BER

#### Remote commands:

```
//set measurement mode (example BER)
CONFigure:GSM:SIGN<i>:BER:CSWitched:MMODE BER
//set number of frames/bursts
CONFigure:GSM:SIGN<i>:BER:CSWitched:SCOUNT 100

INITiate:GSM:SIGN<i>:BER:CSWitched           // start measurement
FETCh:GSM:SIGN<i>:BER:CSWitched?           // get results
```

#### PS BER

This measurement calculates bit error rates and data block error rates in packet switched connections. Typically the CMW transmits data which are looped back by the DUT (see 5.1, detailed information is available in []).

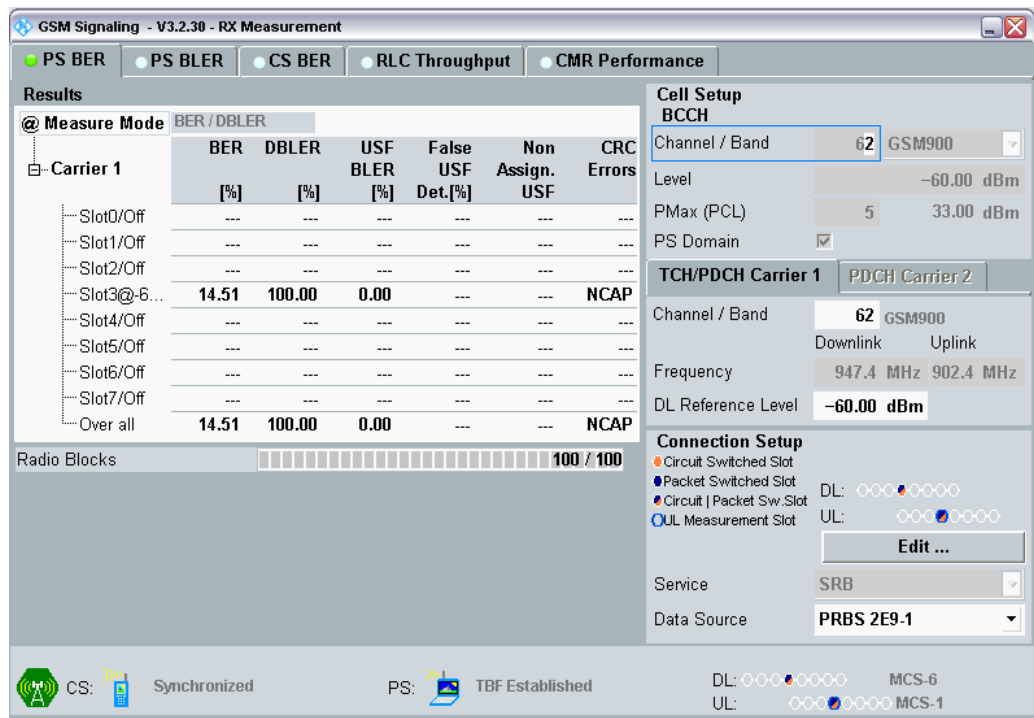

Fig. 5-5: PS (packet switched) BER in GSM

Remote commands:

```
//set measurement mode (example BER/DBLER)
CONFigure:GSM:SIGN<i>:BER:PSWitched:MMODE BDBLER
//set number of RLC blocks
CONFigure:GSM:SIGN<i>:BER:PSWitched:SCOUNT 100

INITiate:GSM:SIGN<i>:BER:PSWitched // start measurement
FETCh:GSM:SIGN<i>:BER:PSWitched? // get results
```

**PS BLER**

This measurement calculates block error rates in packet switched connections. The CMW sends data to the MS and determines the block error rate (BLER) from the positive ACKnowledgments (ACK) and negative ACKnowledgments (NACK) returned by the MS. Additionally the Data Rate is calculated from the BLER results (see 5.1).

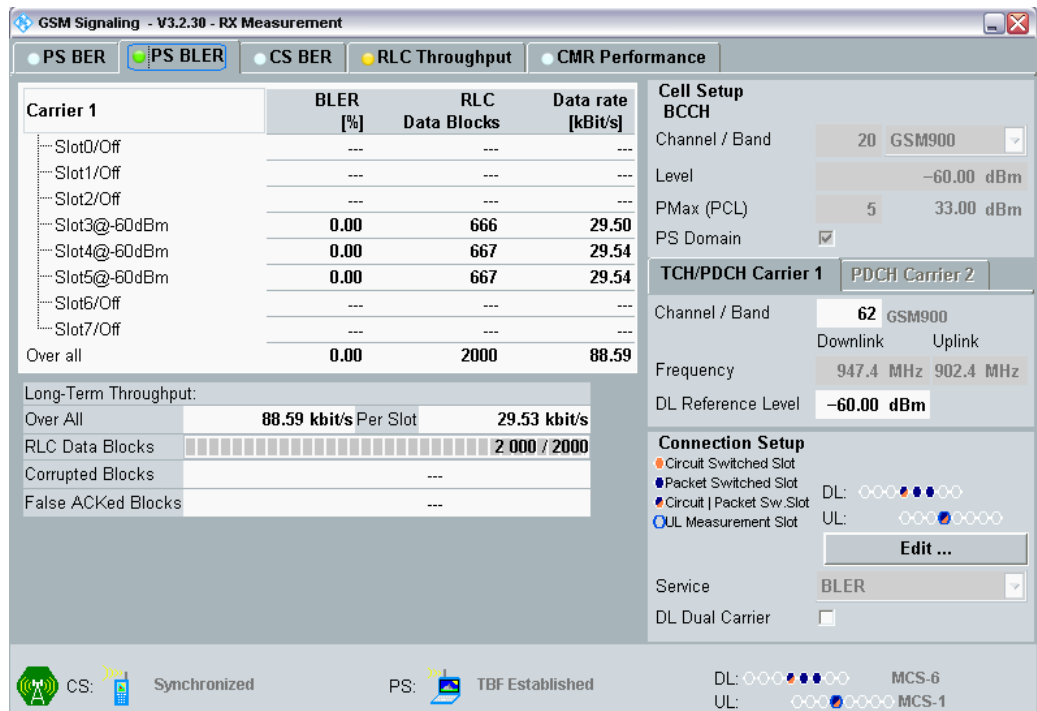

Fig. 5-6: PS (packet switched) BLER in GSM

Remote commands:

```
//set measurement mode (example BER/DBLER)
CONFIGure:GSM:SIGN<i>:BER:PSWitched:MMODE DBBLer
//set number of RLC blocks
CONFIGure:GSM:SIGN<i>:BER:PSWitched:SCOUNT 100

INITiate:GSM:SIGN<i>:BER:PSWitched // start measurement
FETCh:GSM:SIGN<i>:BER:PSWitched? // get results
```

RLC Throughput

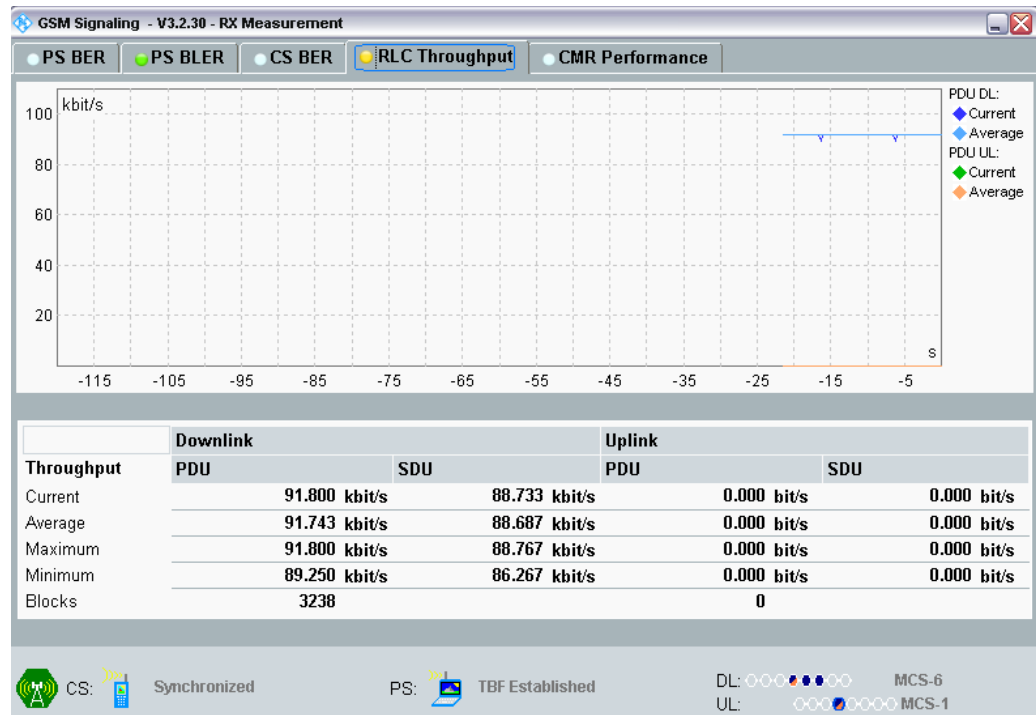

Fig. 5-7: RLC throughput in GSM

## 5.2 Fading Scenario

In GSM fading on one path only is applied.

1. In the **GSM Signaling Configuration**, select the *Standard Cell Fading Scenario* (see Fig. 3-6). Set the **Fading** to *External*. The crest factor depends on the used modulation (GMSK, 8PSK, AQPSK, 16QAM or 32QAM). In addition, the CMW uses a reserve, which depends on the connection state (Cell on, Call established, Dual carrier Call established) to the MS. This causes different crest factors displayed in the IQ out section. The CMW uses the following factors:



GSM used crest factors			
Coding schemes	Modulation	Used crest factor	
		Call established	Dual Carrier Call established
Normal voice call			
GPRS (CS 1...4)	GMSK	6.00 dB	9.54 dB
EGPRS (MCS 1...4)			
EGPRS (MCS 5...9)	8PSK	9.23 dB	12.77 dB
EGPRS2 (DAS 5...7)			
EGPRS2 (DAS 8...9)	16QAM	11.77 dB	15.31 dB
EGPRS2 (DAS 10...12)	32QAM	12.11 dB	15.65 dB
VAMOS	AQPSK	9.39 dB	12.93 dB

Table 5-4: CMW Crest factors in GSM

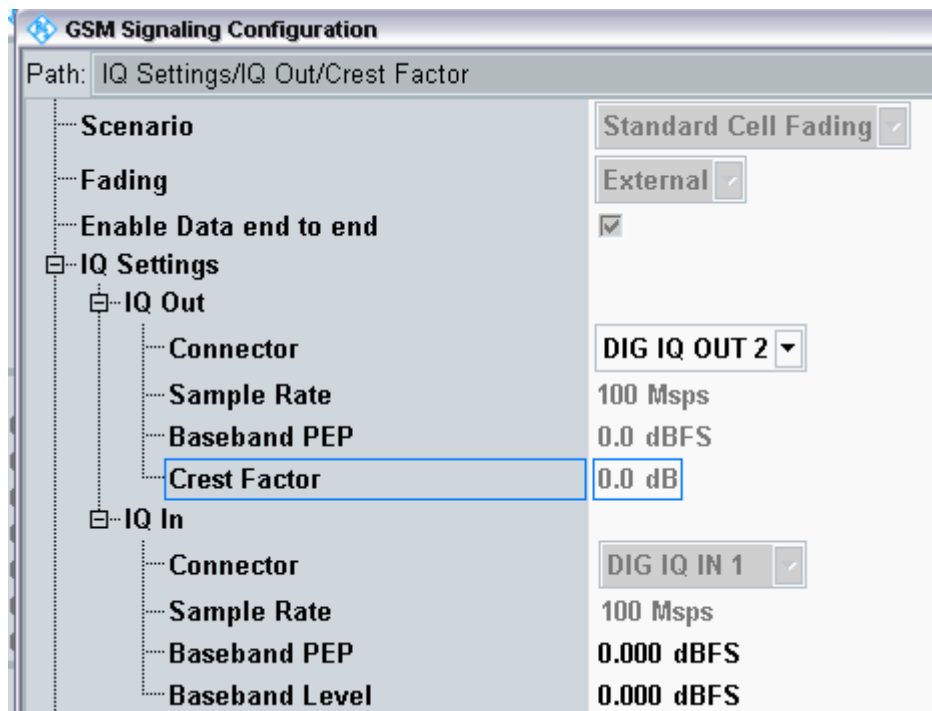

Fig. 5-8: GSM scenario: Standard Cell Fading. The CMW indicates the crest factor, which is entered in the SMW's Dig IQ Input. As the crest factors depends on the used modulation and connection state, different factors may appear.

Remote commands:

```
// Standard Cell Fading external via RF2COM and IQ2 Out
ROUTE:GSM:SIGN:SCENario:SCFading RF2C,RX1,RF2C,TX1,IQ2O

// read out information of IQ settings
SENSe:GSM:SIGN<i>:IQOut:PATH<n>?
```

2. Take note of the **Crest Factor** under **IQ Out** or take it from [Table 5-4](#) and enter this value in the SMW under **Baseband Input Level** (see [Fig. 2-13](#) in section 2.3).
3. Set a fading and switch on **I/Q Out** (BBMM1)(see section 2.3).
4. In the CMW, enter the corresponding baseband level (Level  $BB_{out\ SMW} = Crest\ Factor_{In\ SMW} - Insertion\ Loss$ ; example:  $-6\ dB - 10\ dB = -16\ dBFS$ , see [2.3.8](#) ), which is indicated by the SMW (see [Fig. 5-10](#)). If you add noise to the signal, note the crest factor without noise.
5. Use **CS CONNECT** or **PS CONNECT** to establish a GSM connection between the CMW and DUT.
6. If you modify the fading, remember to change the level accordingly in the CMW.

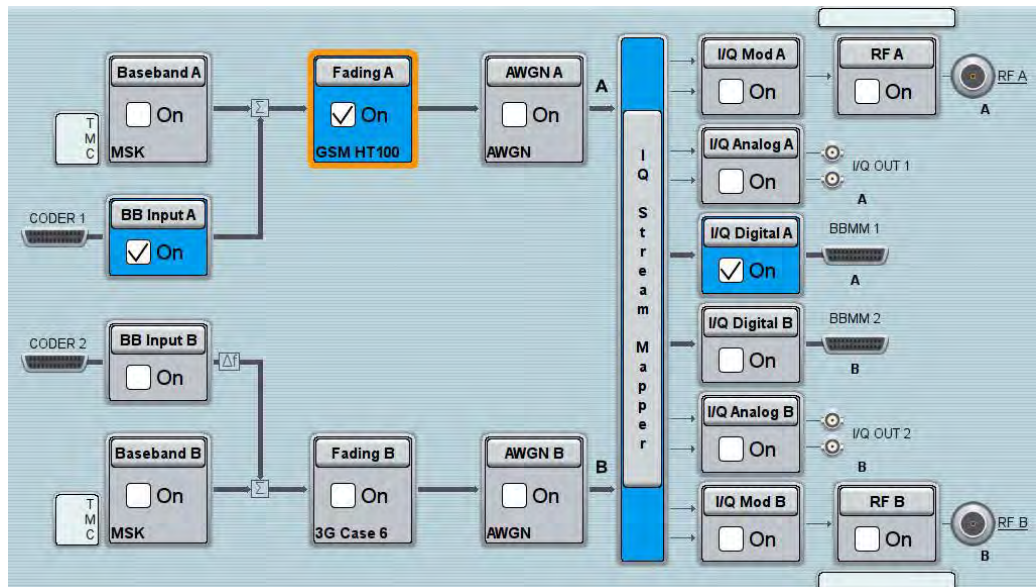

Fig. 5-9: Overview SMW settings for GSM.

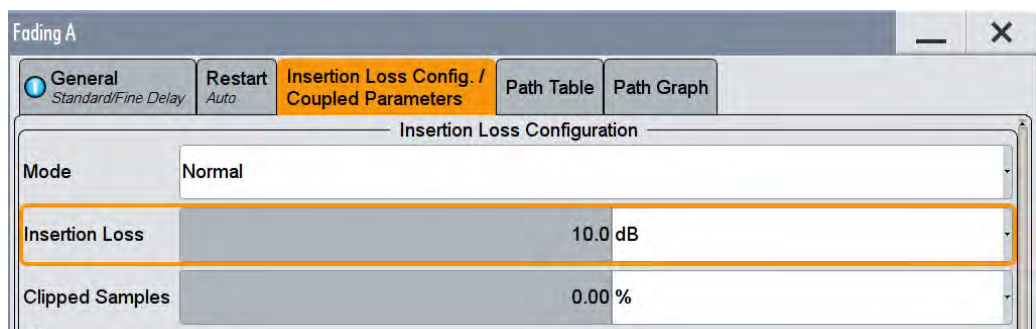

Fig. 5-10: The SMW shows the necessary insertion loss (example: 10 dB)

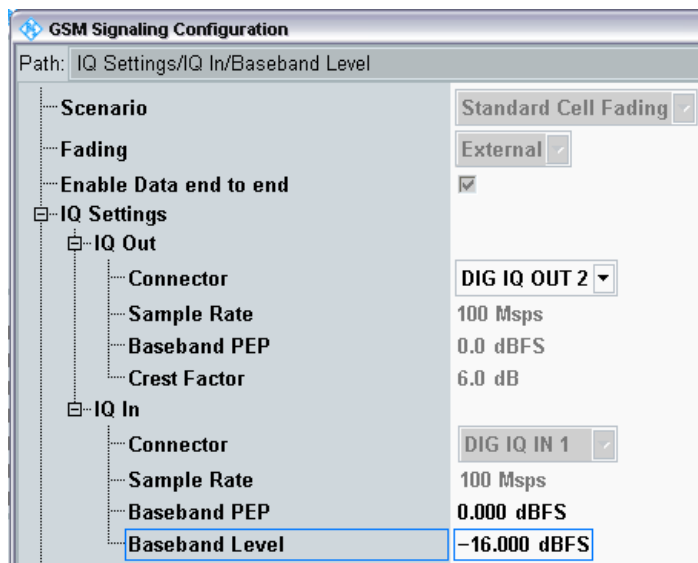

Fig. 5-11: Making allowance for the necessary attenuation in the CMW. Here, the digital output level of the SMW signal is entered as the IQ In level.

Remote command:

```
// set IQ In to PEP 0 dBFS and Level -16 dBFS
CONFigure:GSM:SIGN<i>:IQIN:PATH<n> 0.0, -16.0
```

7. Start the RX measurement using **Rx MEAS** (see section 5.1). Fig. 3-11 shows an example.

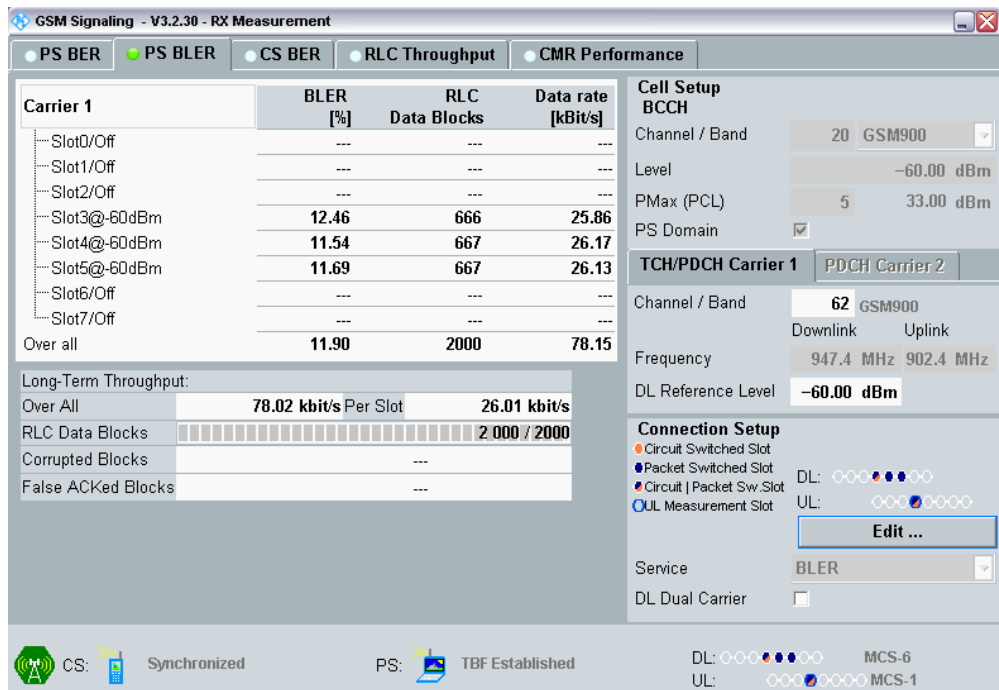

Fig. 5-12: Example for a RX measurement in GSM: PS BLER on three downlink slots.

### 5.3 Fading with Hopping (single DL carrier)

The GSM standard also uses frequency hopping (FH) (3GPP TS 45.002). The CMW together with the SMW allows tests under fading conditions in combination with frequency hopping.

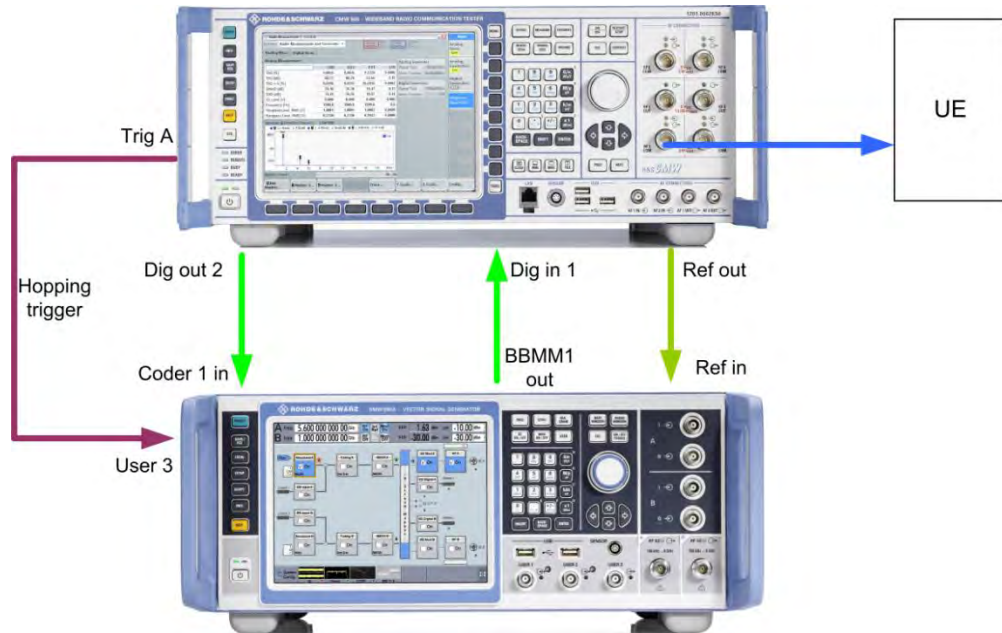

Fig. 5-13: Test setup GSM with hopping: the CMW provides the hopping trigger

To perform measurements with fading and hopping, use the same steps and settings like in 5.2. In addition following steps are necessary:

1. Connect CMW output **Trig A** to SMW input **USER 3**.
2. Make sure that the **Hopping Trigger** is output at **TRIG A** (SETUP|Misc|Trigger).

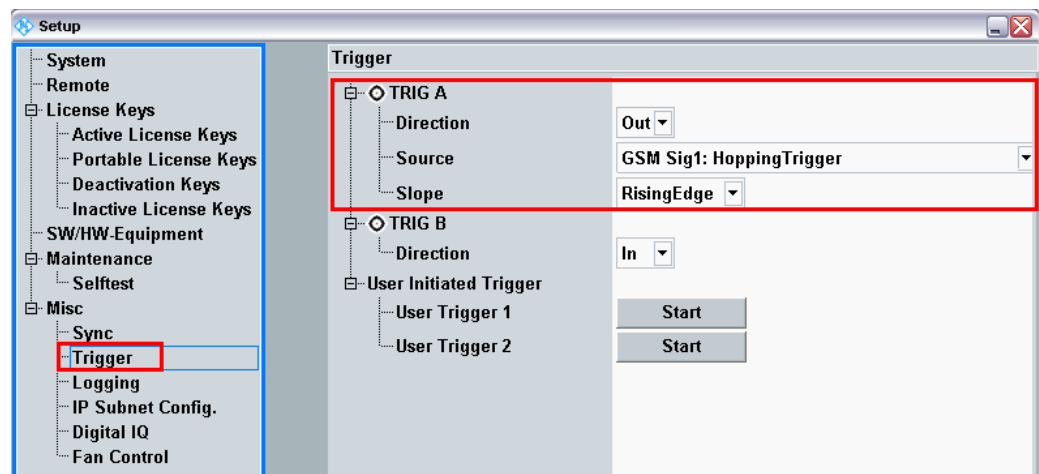

Fig. 5-14: The CMW provides the hopping trigger at TRIG A.

Remote commands:

```
// Trigger A Output
TRIGger:BASE:EXTA:DIRection OUT
// Trigger A GSM1 Signalling Hopping
TRIGger:BASE:EXTA:SOURce "GSM Sig1: HoppingTrigger"
```

3. Create a **Hopping List** in the CMW.

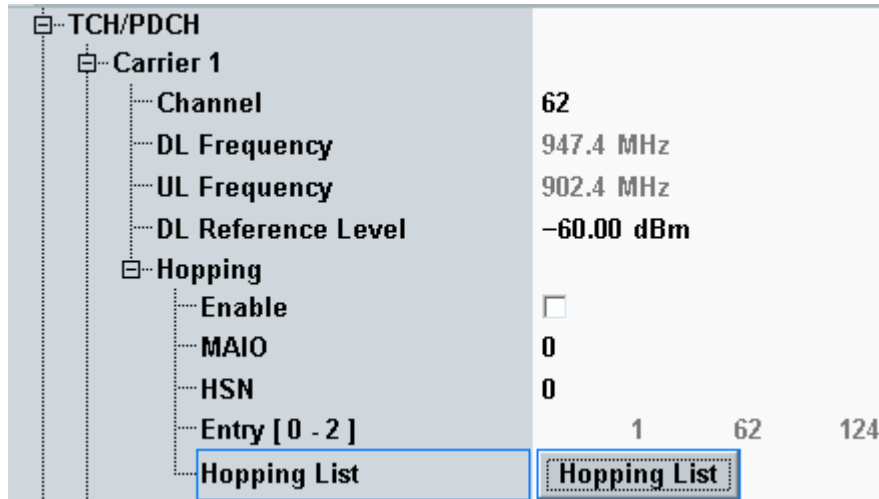

Fig. 5-15: Hopping settings in the CMW

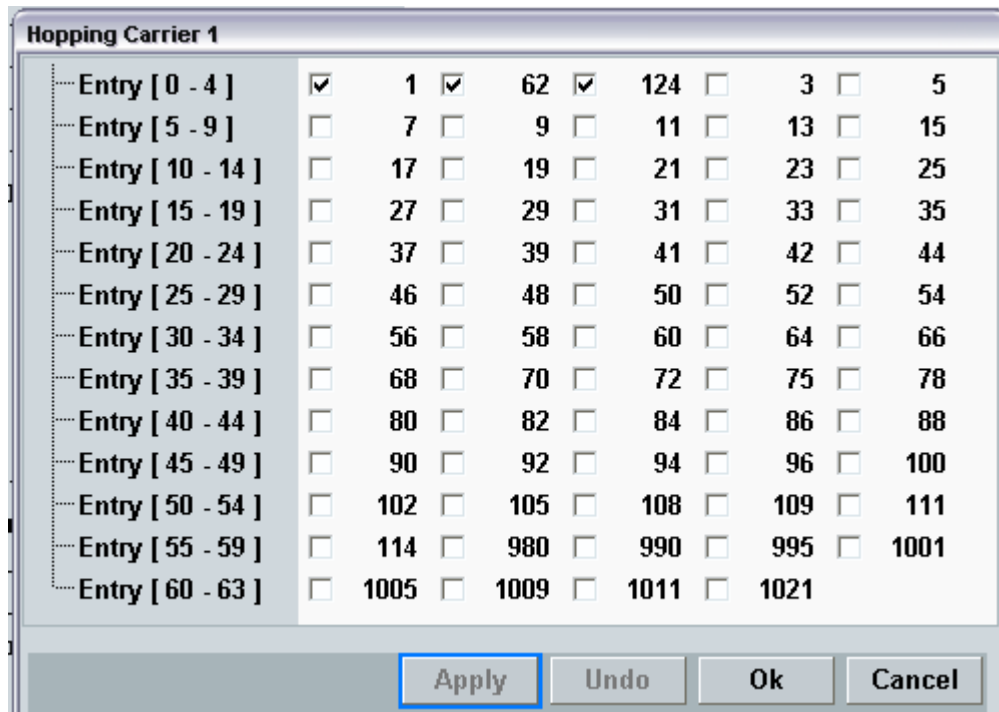

Fig. 5-16: The hopping list in the CMW

**Important note:** Please note that the actual hopping sequence depends on the MAIO and HSN settings. The sequence may not start at the beginning of the list. In packet switched connections also the entire list may not be used (see Manual [9] and 45.002).

Remote commands:

```
// Hopping list entries channel 1,62, 124
CONFigure:GSM:SIGN<i>:RFSettings:HOPping:SEquence:TCH 1,62,124
// Set MAIO to 0
CONFigure:GSM:SIGN<i>:RFSettings:HOPping:MAIO:TCH 0
// Set HSN to 0
CONFigure:GSM:SIGN<i>:RFSettings:HOPping:HSN:TCH 0
```

- To use fading with hopping in the SMW, the fading must be dedicated to the RF output. Set the Frequency Hopping mode to **In Band**.

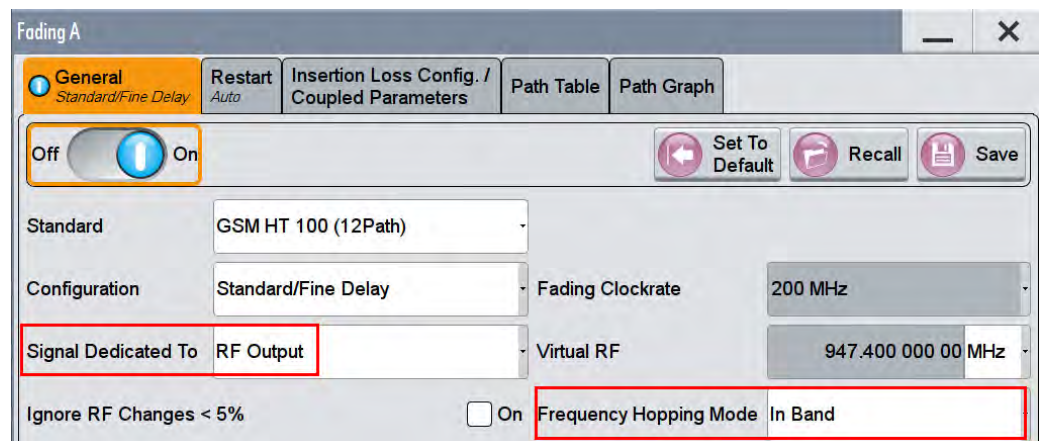

Fig. 5-17: Fading settings with hopping. The signal must be dedicated to RF Output.

Remote commands SMW:

```
SOURcel1|2:FSIMulator:SDESTination RF // Destination RF
SOURcel1|2:FSIMulator:HOPping:MODE IBAND // In band hopping
```

- Turn on the SMW RF A output **ON** to use the **List Mode** capability. Anyhow, the actual RF output is not used.

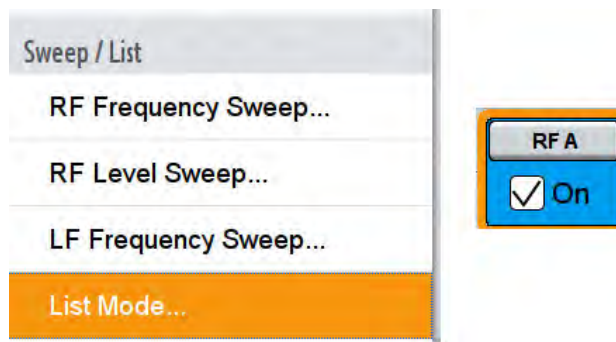

Fig. 5-18: For hopping the List mode is used in RF A.

6. Create or edit a list with the same entries like in the CMW (Convert the channels via the internal function in the CMW, the manual [9] or the iOS App *Wireless Communication Calculator*). Set the Mode to **Extern Step** and switch **ON**.

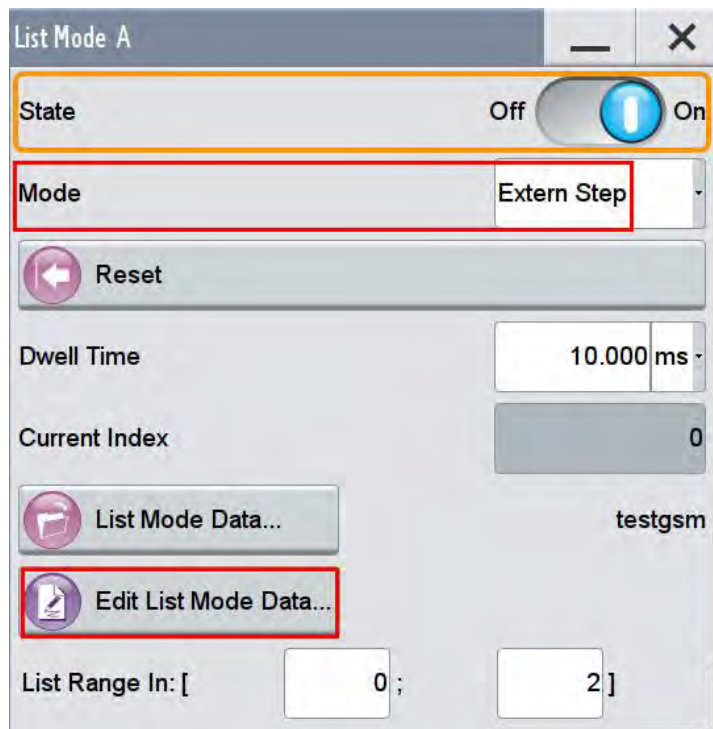

Fig. 5-19: List mode settings in the SMW

Important note: Please note that the last entry of the CMW hopping sequence has to be entered as the first entry of the SMW list. In the example the CMW list 1, 62, 124 has to be entered in the SMW as 124, 1, 62 (Channel 1 ≙ 935.2 MHz).

Edit List Mode Data A testgsm		
	Frequency / Hz	Power / dBm
1	959 800 000.000	-70.00
2	935 200 000.000	-70.00
3	947 400 000.000	-70.00

Fig. 5-20: List with three entries. The power settings are not used actually.

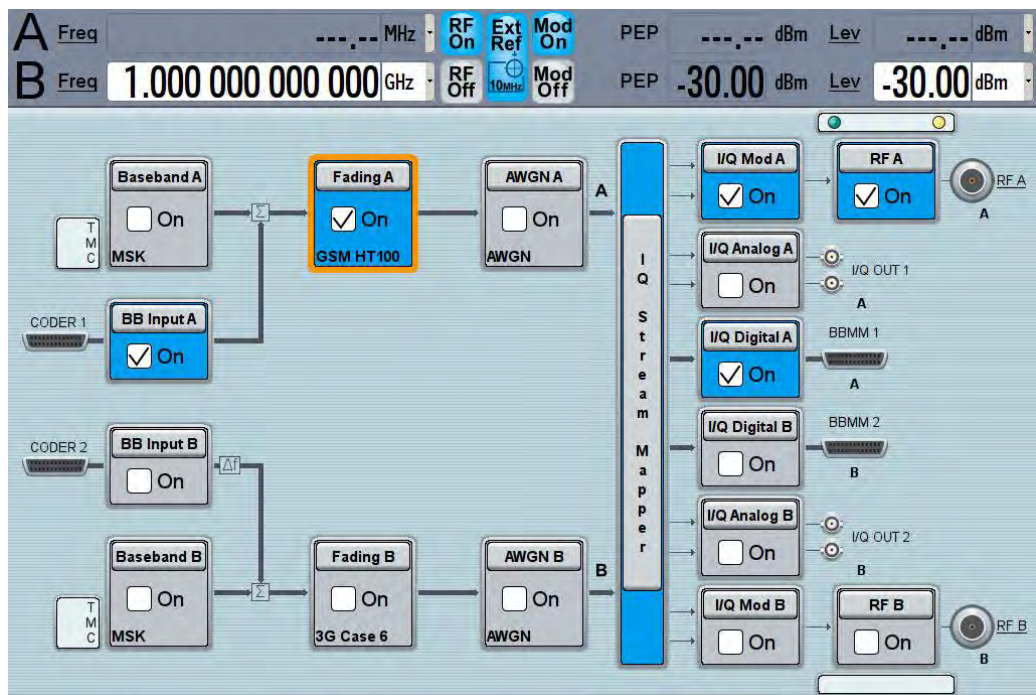

Fig. 5-21: Overview SMW for fading with hopping. The SMW uses the list mode in the RF.

Remote commands:

```

OUTPut1:STATe ON // Switch RF A On
SOURce1:FREQ:MODE LIST // Switch to List mode
SOURce1:LIST:TRIGger EXT // Trigger External
SOURce1:LIST:MODE STEP // Step mode
SOURce1:LIST:POWer -70 dBm, -70 dBm, -70 dBm
SOURce1:LIST:FREQuency 959.8 MHz, 935.2 MHz, 947.4 MHz
    
```

7. Establish a **Connection**, then enable the **Hopping**.



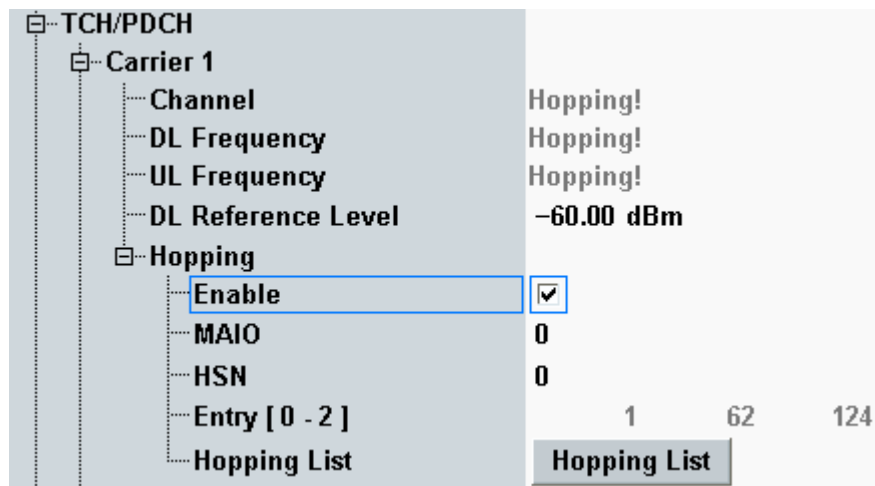

Fig. 5-22: Enabling the hopping in the CMW

```
// Enable Hopping
CONFigure:GSM:SIGN<i>:RFSettings:HOPping:ENABle:TCH ON
```

8. Start a Measurement.

## 5.4 Fading with DL Dual Carrier

Since the introduction of EDGEvolution in Release 7 two downlink carriers can be dedicated to one MS. This feature is called DL Dual carrier. Both carriers are independent from each other. Typically there is a frequency gap between both carriers and both can use the whole GSM frequency band.

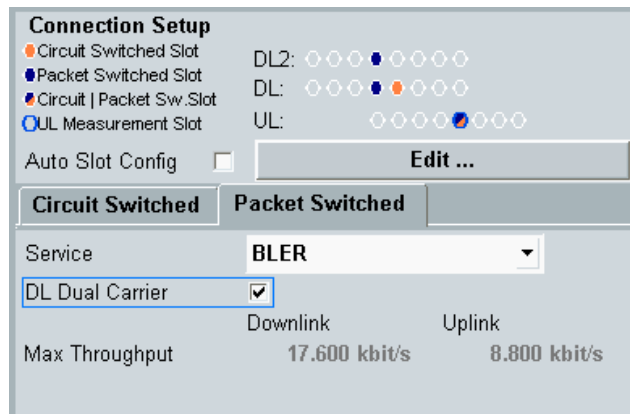

Fig. 5-23: DL Dual Carrier mode

As both carriers are generated in one baseband in the CMW and thus routed in the fading scenario via only one Digital IQ output to the SMW, it is not possible to apply fading to both carriers independently.

Anyway, fading is possible with the SMW.

**Non hopping mode**

If both carriers remain on fixed frequencies, just set the calculation frequency of the SMW in the middle of both carrier frequencies.

Example:

Fading Frequency			
Carrier	Channel	Frequency	Fading Frequency SMW
1	62	947.4 MHz	948.4 MHz
2	72	949.4 MHz	

**Hopping mode**

In hopping mode both carriers may use completely independent hopping sequences. Even one carrier can hop and the other remains at one frequency. Again, set the calculation frequency of the SMW in the middle of all possible carrier frequencies.

Example:

Fading Frequency			
Carrier	Channel	Max Frequency range	Fading Frequency SMW
1	1, 62, 124	Channel 1 and 124 935.2 MHz and 959.8 MHz	947.5 MHz
2	2, 72, 123		

**5.5 CMW Internal Fading for GSM and (E)GPRS(2)**

For the GSM scenario:

- Standard Cell Fading

the internal fading in the CMW can be used with the software option CMW-KE200. It allows the predefined fading settings (3GPP TS 45.005 annex C.3):

- Urban area (TU)
- Hilly terrain (HT)
- Rural area (RA)
- Equalization tests (EQ)
- Very small cell (TI)
- All models involve a movement of the MS. The speed of movement in km/h is indicated as part of the profile name, the number of propagation paths is also indicated. Example: "TU3 (6 path)" means urban area, MS moving with 3 km/h, 6 propagation paths.

1. Set the wanted **Scenario** and set **Fading** to *Internal*.

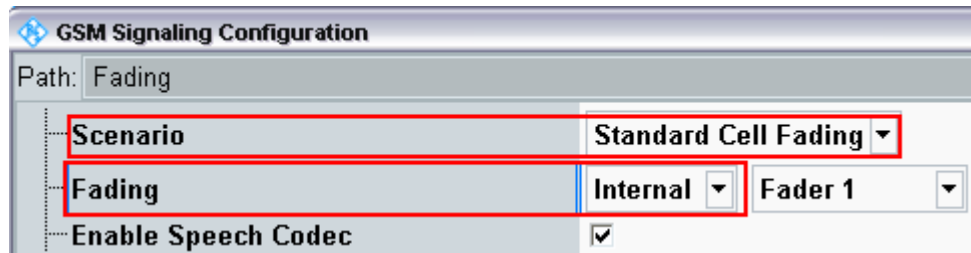

Fig. 5-24: GSM scenario with internal fading

Remote commands:

```
// Standard Cell Fading external via RF2COM
ROUTE:GSM:SIGN:SCENARIO:SCFading:INTERNAL RF2C,RX1,RF2C,TX1
```

2. Select under **Fading Simulator** the wanted *Profile* (example Case 1)
3. **Enable** the Fading

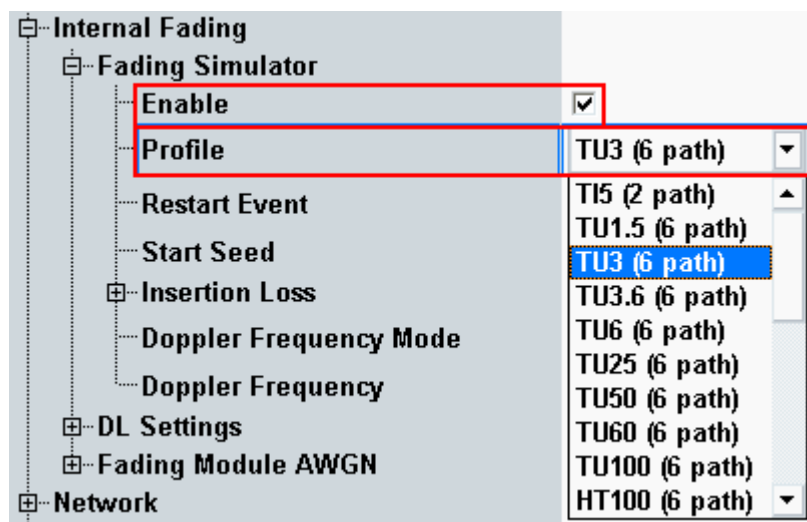

Fig. 5-25: internal GSM fading profiles

Remote commands:

```
// Fading profile TU3 6 paths
CONFIGURE:GSM:SIGN<i>:FADING:FSIMULATOR:STANDARD T3P6
// Switch on FADING
CONFIGURE:GSM:SIGN<i>:FADING:FSIMULATOR:ENABLE ON
```

4. If wanted, apply AWGN by setting the **Signal/Noise** and enable the AWGN.

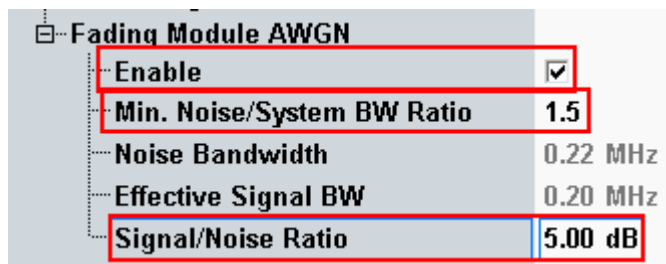

Fig. 5-26: internal GSM AWGN section

**Remote commands:**

```
// Ratio 1.5
CONFigure:GSM:SIGN<i>:FADing:AWGN:BWIDth:RATio 1.5

// Signal/Noise 5.0
CONFigure:GSM:SIGN<i>:FADing:AWGN:SNRatIo 5.0

// Switch on AWGN
CONFigure:GSM:SIGN<i>:FADing:AWGN:ENABle ON
```

5. Start the measurement (see 5.1).

Please note, that with internal fading, the fading with hopping is not calculated for every frequency. The full internal baseband frequency can be used for the hopping. The same applies in principle for Dual carrier setups.

## 6 TD-SCDMA Measurements

With the TD-SCDMA (or 3GPP UTRA-TDD option) standard, the UE receiver measurements includes BER, BLER, DBLER and additional information. All measurements are summarized in the **TDSCDMA RX Meas** measurement application (see 6.1).

Before starting the TD-SCDMA signaling, external fading must be selected as the scenario. Once signaling has begun, or once a connection has been established with the DUT, it is no longer possible to change scenarios.

This section describes the necessary steps to perform a TD-SCDMA Rx measurement.

For further information on TD-SCDMA signaling and BER measurements, refer to [10].

### 6.1 UE Receiver Measurement in TD-SCDMA: Rx Meas

#### BER

This measurement calculates bit error rates in test mode connections. Typically the CMW transmits data which are looped back by the DUT. Please note that the BER works in **Test Mode** connections only.

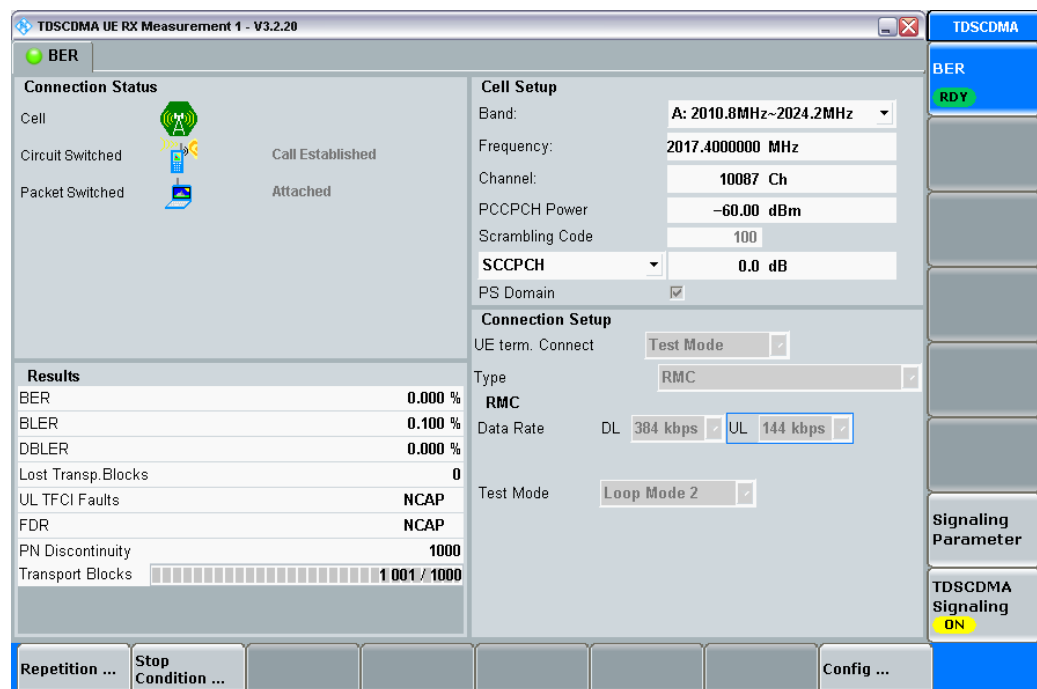

Fig. 6-1: Example for BER in TD-SCDMA

Remote commands:

```
//set number of transport blocks
CONFigure:TDSCdma:SIGN<i>:BER:TBLocks 1000

INITiate:TDSCdma:SIGN<i>:BER // start measurement
FETCh:TDSCdma:SIGN<i>:BER? // get results
```

## 6.2 Fading Scenario

In TD-SCDMA fading on one path only is applied.

1. In the **TDSCDMA Signaling Configuration**, select the *Standard Cell Fading Scenario* (see Fig. 6-2). Set the **Fading** to *External*.

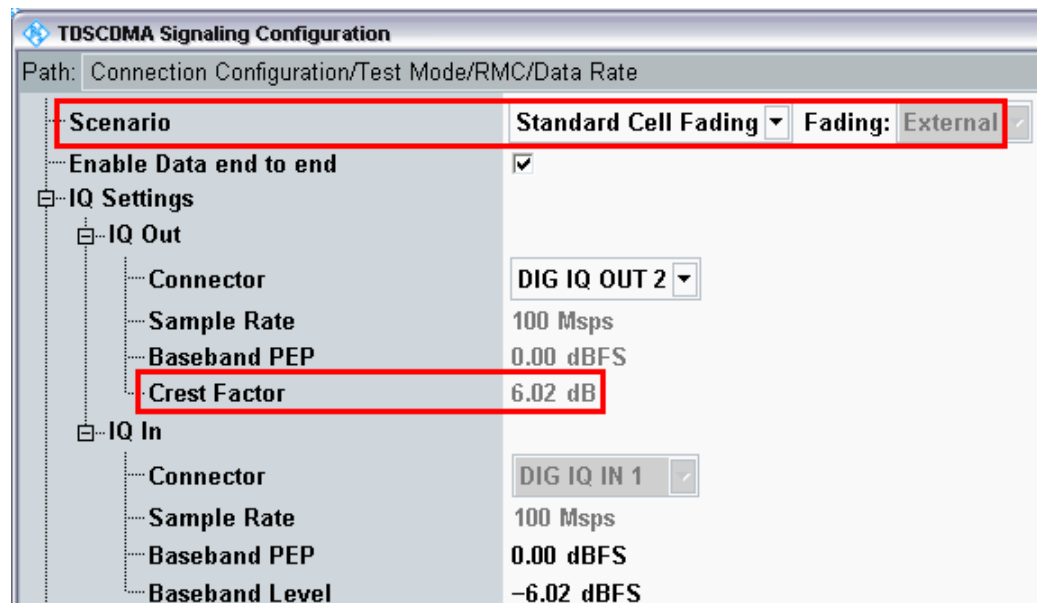

Fig. 6-2: TD-SCDMA scenario: Standard Cell Fading. The CMW indicates the crest factor, which is entered in the SMW's Dig IQ Input.

Remote commands:

```
// Standard Cell Fading external via RF2COM and IQ2 Out
ROUTE:TDSCdma:SIGN:SCENario:SCFading RF2C,RX1,RF2C,TX1,IQ2O
// read out information of IQ settings
SENSe:TDSCdma:SIGN<i>:IQOut:PATH<n>?
```

2. Take note of the **Crest Factor** under **IQ Out** and enter this value in the SMW under **Baseband Input Level** (see Fig. 2-13 in section 2.3).
3. Set a fading and switch on **I/Q Out** (BBMM1)(see section 2.3).
4. In the CMW, enter the corresponding baseband level ( $\text{Level BB}_{\text{out SMW}} = \text{Crest Factor}_{\text{In SMW}} - \text{Insertion Loss}$ ; example:  $-6.02 \text{ dB} - 10 \text{ dB} = -16.02 \text{ dBFS}$ , see 2.3.8 ), which is indicated by the SMW (see Fig. 6-4). If you add noise to the signal, note the crest factor without noise.

5. Use **CONNECT Test Mode** to establish a TD-SCDMA connection between the CMW and DUT.
6. If you modify the fading, remember to change the level accordingly in the CMW.

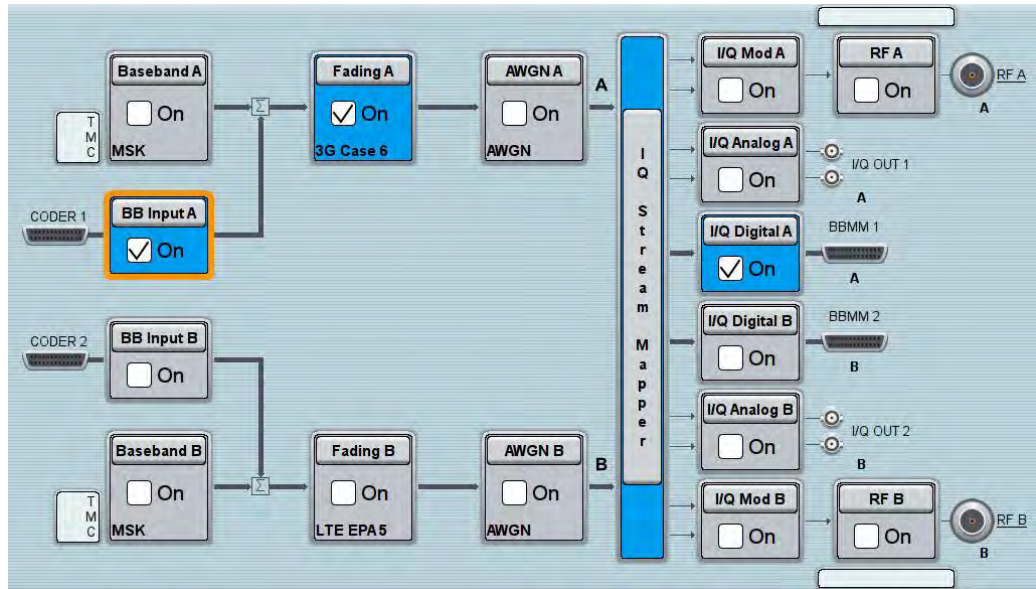

Fig. 6-3: Overview SMW settings for TD-SCDMA.

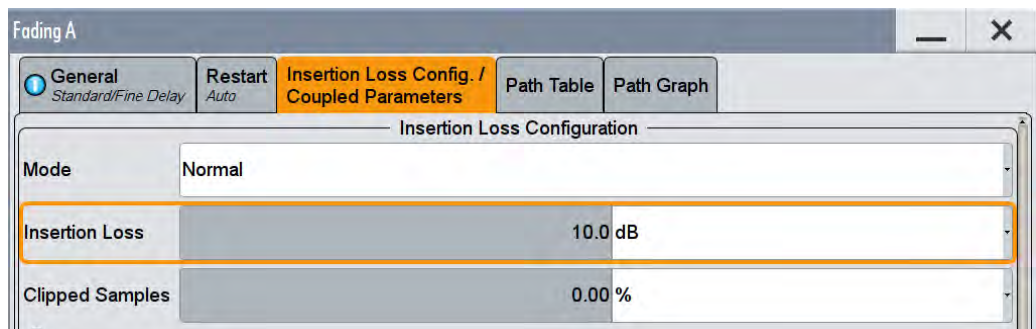

Fig. 6-4: The SMW shows the necessary insertion loss (example: 10 dB)

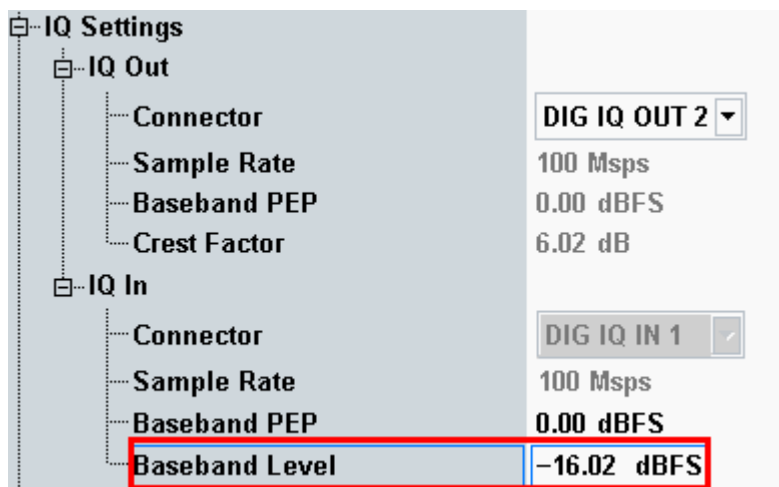

Fig. 6-5: Making allowance for the necessary attenuation in the CMW. Here, the digital output level of the SMW signal is entered as the IQ In level.

Remote command:

```
// set IQ In to PEP 0 dBFS and Level -16.02 dBFS
CONFigure:TDSCdma:SIGN<i>:IQIN:PATH<n> 0.0, -16.02
```

7. Start the RX measurement using **Rx MEAS** (see section 6.1). Fig. 6-6 shows an example.

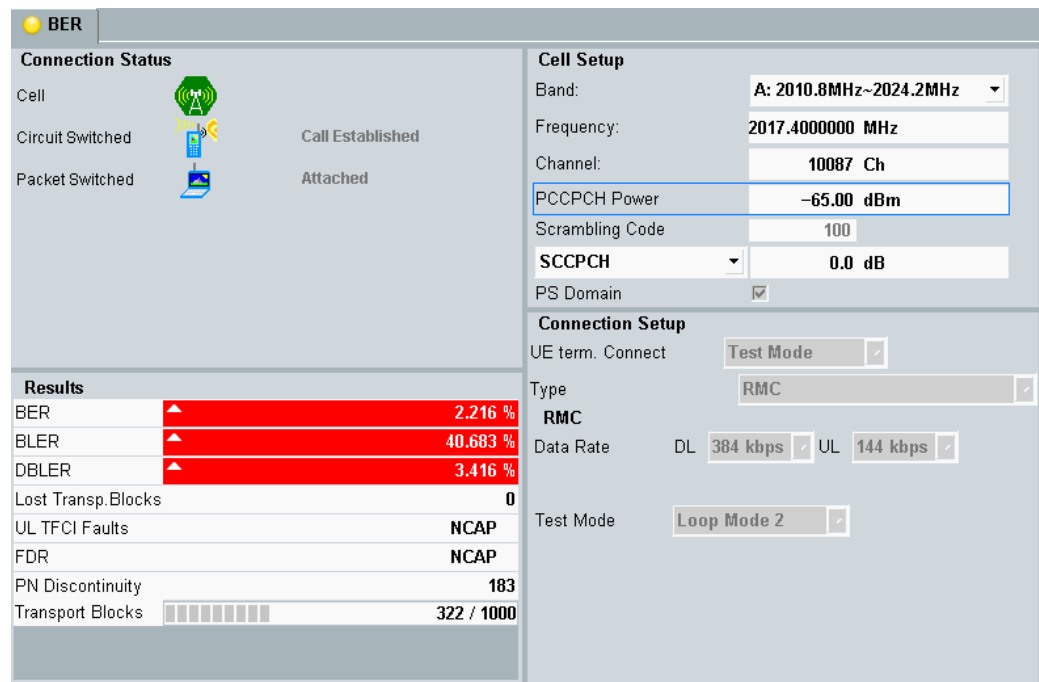

Fig. 6-6: Example for a RX measurement in TD-SCDMA.



## 7 CDMA2000 and 1xEV-DO Measurements

With the 3G standards CDMA2000 and 1xEV-DO, 3GPP2 introduced a mixed voice and data standard CDMA/CDMA2000 and a full IP data packet standard 1xEV-DO.

The CMW supports both standards as software options, in addition also a so called hybrid mode is available.

For further information on signaling and Rx measurements, refer to [11].

### 7.1 CDMA2000

With the CDMA2000 (3GPP2) standard, the UE receiver measurements includes a Frame Error Rate (FER), RLP, Pilot Strength and Speech measurements. All measurements are summarized in the **CDMA2000 RX Meas** measurement application (see 7.1.1).

Before starting the CDMA2000 signaling, external fading must be selected as the scenario. Once signaling has begun, or once a connection has been established with the DUT, it is no longer possible to change scenarios.

This section describes the necessary steps to perform a CDMA2000 Rx measurement.

The CMW supports following service options (SO):

Service Options		
Mode	Service Option	Data
Speech	1, 3, 17, 68, 70, 73 and 0x8000	Voice
Loopback	2, 9, and 55	Data
Test Data	32	Data
Packet Data	33	Data

Please note that for SO33, packet data are provided by the DAU (see 8.5).

CDMA2000 defines different radio configurations (RC) with different modulations schemes and data rates,

Radio Configuration forward channel			
RC	Max Data rate Kbit / s	Modulation	Standard
1	9.6	O-QPSK	cdmaOne
2	14.4		
3	153.6	H-PSK	CDMA2000
4	307.2		
5	230.4		

### 7.1.1 Mobile Station Receiver Measurement in CDMA2000: Rx Meas

Rx Meas in CDMA2000 provide different measurements, which also require different service options (SO):

Service Options		
Mode	Service Option	Data
Speech	1, 3, 17, 68, 70, 73 and 0x8000	Voice
Loopback	2, 9, and 55	Data
Test Data	32	Data
Packet Data	33	Data

Measurements				
Rx Measurement	1, 3, 17, 68, 70, 73, 0x8000 Speech	2, 9, 55 Loopback	32 Test Data	33 Packet Data
FER FCH and FER SCH0		<input checked="" type="checkbox"/>	<input checked="" type="checkbox"/>	
RLP				<input checked="" type="checkbox"/>
Pilot Power	<input checked="" type="checkbox"/>	<input checked="" type="checkbox"/>	<input checked="" type="checkbox"/>	<input checked="" type="checkbox"/>
Speech	<input checked="" type="checkbox"/>			

#### FER FCH and FER SCH0

Here the Frame Error Rate of the Fundamental Channel (FCH) and the Supplemental Channel 0 (SCH0) are determined. Views of both channels are analogical.

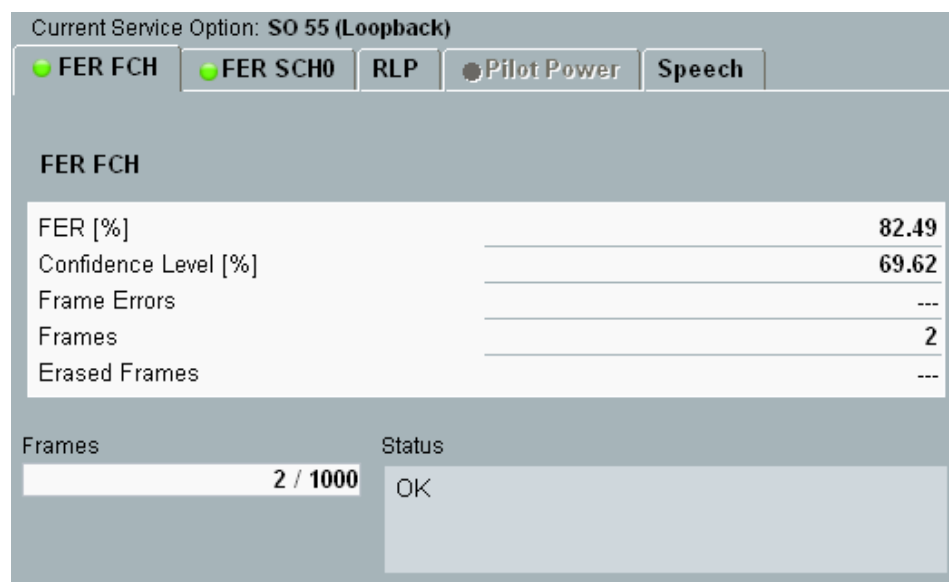

Fig. 7-1: Frame Error Rate measurement in CDMA200

Remote commands:

```
INITiate:CDMA:SIGN<i>:RXQuality:TDAa:FERFch // start
measurement
FETCh:CDMA:SIGN<i>:RXQuality:FERFch? // get results
```

RLP

This tab shows the RLP and IP statistics. This measurement requires an end-to-end data connection with the DAU and SO33.

Current Service Option: SO 33 (Packet Data)				
<input checked="" type="radio"/> FER FCH	<input checked="" type="radio"/> FER SCH0	<input checked="" type="radio"/> RLP	<input type="radio"/> Pilot Power	<input type="radio"/> Speech
RLP & IP Statistics				
RLP Messages	Rx	Rx Total	Tx	Tx Total
Data (Unsegmented)	0	2	0	0
Data (Segmented)	0	112	0	0
Fill	6	762	0	9802
Idle	37	6065	0	0
NAK	0	0	0	34
SYNC	0	9	0	0
ACK	0	8	0	0
SYNCAK	0	0	0	9
B_Data	7	971	50	6861
C_Data	8	1904	400	55002
D_Data	8	1528	0	24
Reassembly	0	0	0	0
Blank	7	1011	0	0
Invalid	0	1	0	0
Summary	66	12680	450	73082
	<b>Rx</b>		<b>Tx</b>	
PPP Total Bytes [kByte]	150		2595	
Data Rate [kBit/s]	3.3		116.3	
Status				
OK				

Fig. 7-2: RLP and IP statistics

Pilot Strength

The MS reports the total received power and the F-PICH power.



Fig. 7-3: Pilot strength

Remote commands:

`SENSe:CDMA:SIGN<i>:RXQuality:RLP:SUMMary? // get results`

Speech

The speech measurement evaluates the traffic flow between DUT and CMW.

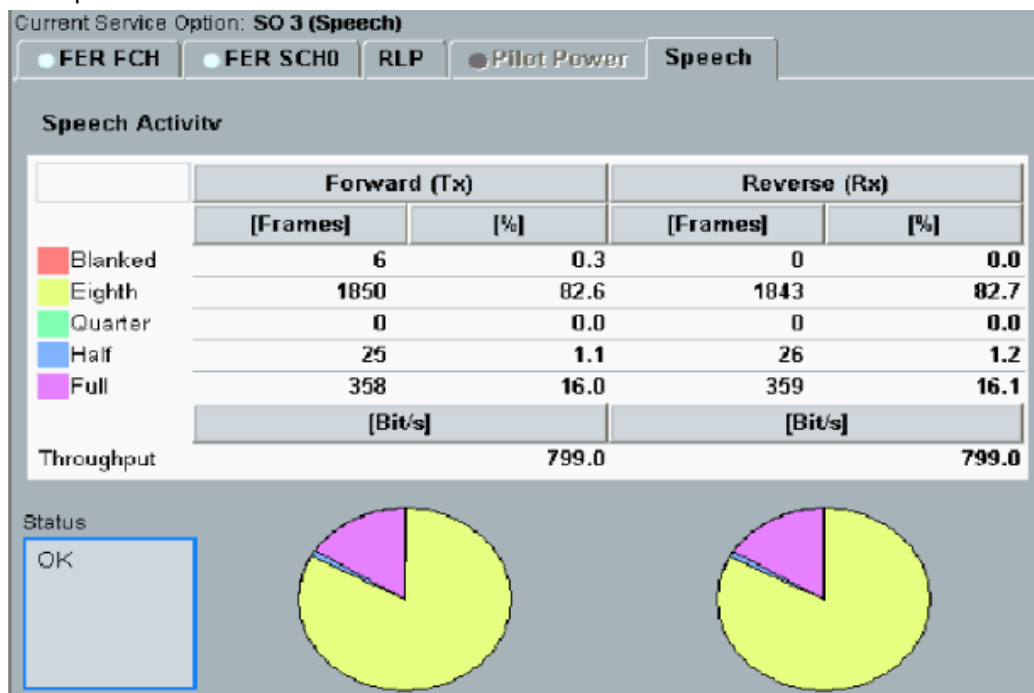

Fig. 7-4: Speech statistics

Remote commands:

`SENSe:CDMA:SIGN<i>:RXQuality:SPEech:THROUGHput? // get results`

## 7.1.2 Fading Scenario

In CDMA2000 fading on one path only is applied.

1. In the **CDMA2000 Signaling Configuration**, select the *Standard Cell Fading Scenario* (see Fig. 6-2). Set the **Fading** to *External*.

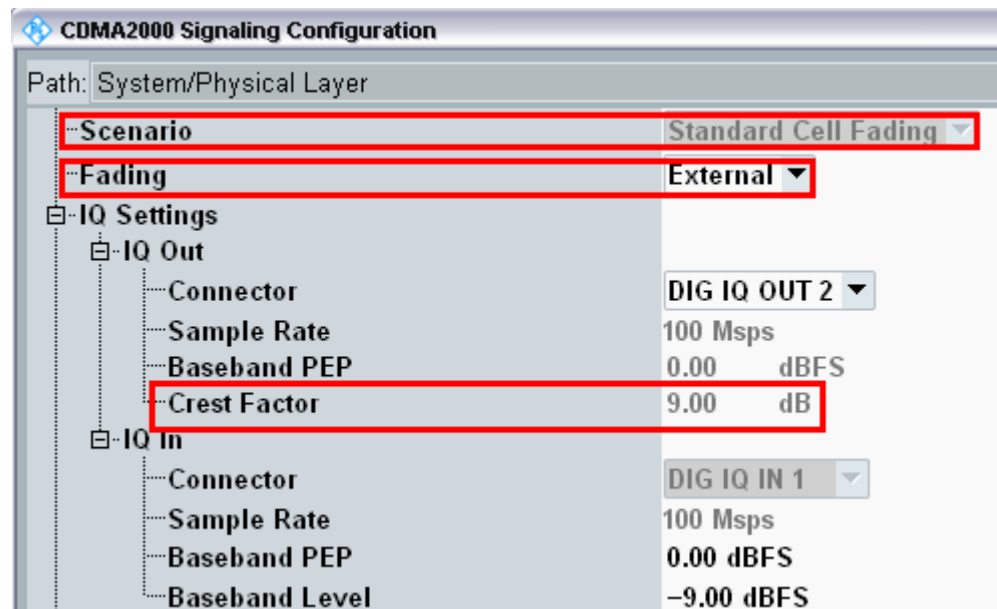

Fig. 7-5: CDMA2000 scenario: Standard Cell Fading. The CMW indicates the crest factor, which is entered in the SMW's Dig IQ Input.

### Remote commands:

```
// Standard Cell Fading external via RF2COM and IQ2 Out
ROUTE:CDMA:SIGN:SCENARIO:SCFading RF2C,RX1,RF2C,TX1,IQ2O
// read out information of IQ settings
SENSE:CDMA:SIGN<i>:IQOut:PATH<n>?
```

2. Take note of the **Crest Factor** under **IQ Out** and enter this value in the SMW under **Baseband Input Level** (see Fig. 2-13 in section 2.3).
3. Set a fading and switch on **I/Q Out** (BBMM1)(see section 2.3).
4. In the CMW, enter the corresponding baseband level ( $\text{Level BB}_{\text{out SMW}} = \text{Crest Factor}_{\text{In SMW}} - \text{Insertion Loss}$ ; example:  $-9.0 \text{ dB} - 10 \text{ dB} = -19.0 \text{ dBFS}$ , see 2.3.8 ), which is indicated by the SMW (see Fig. 7-7). If you add noise to the signal, note the crest factor without noise.
5. Use **CONNECT 1<sup>st</sup> SO** to establish a CDMA2000 connection between the CMW and DUT.
6. If you modify the fading, remember to change the level accordingly in the CMW.

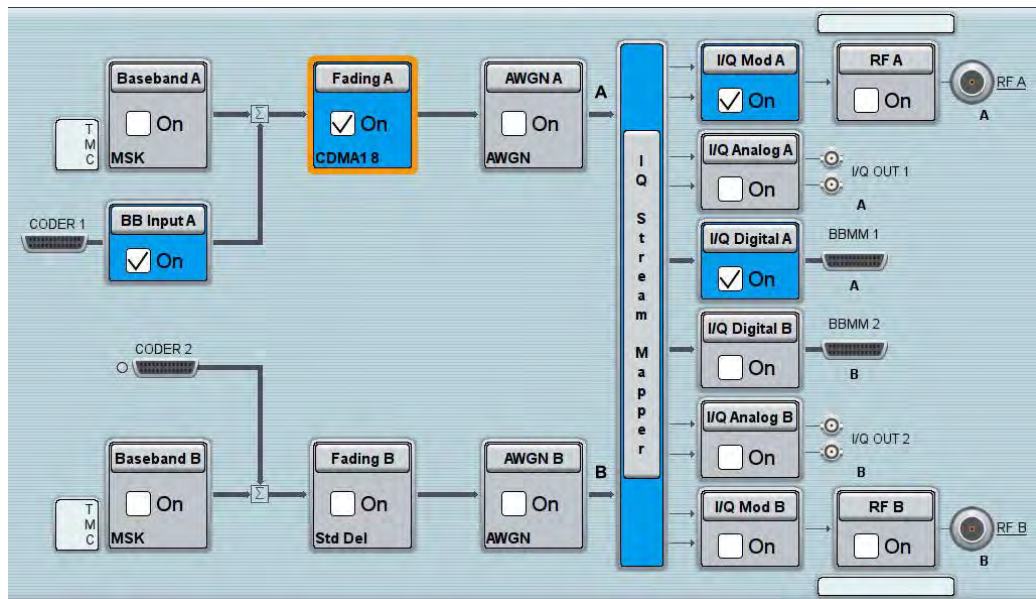

Fig. 7-6: Overview SMW settings for CDMA2000.

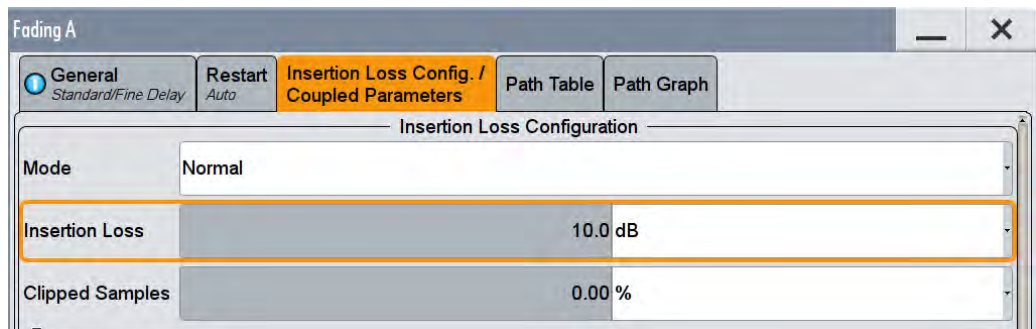

Fig. 7-7: The SMW shows the necessary insertion loss (example: 10 dB)

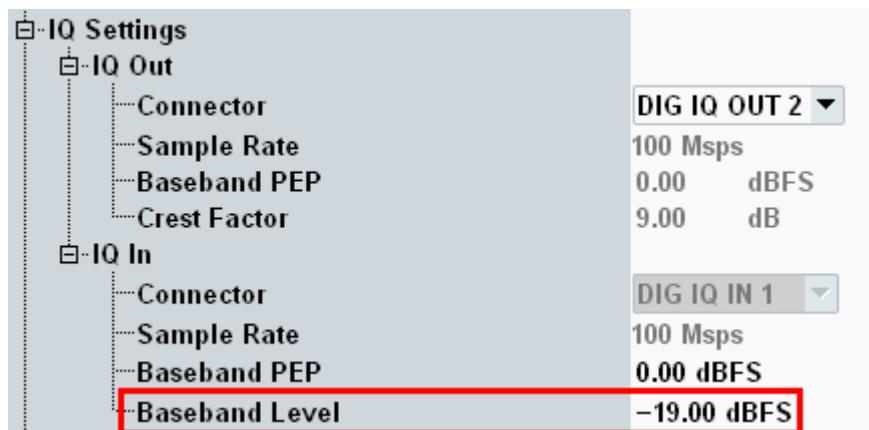

Fig. 7-8: Making allowance for the necessary attenuation in the CMW. Here, the digital output level of the SMW signal is entered as the IQ In level.

Remote command:

```
// set IQ In to PEP 0 dBFS and Level -19.0 dBFS
CONFigure:CDMA:SIGN<i>:IQIN:PATH<n> 0.0, -19.0
```

7. Start the RX measurement using **Rx MEAS** (see section 7.1.1). Fig. 7-9 shows an example.

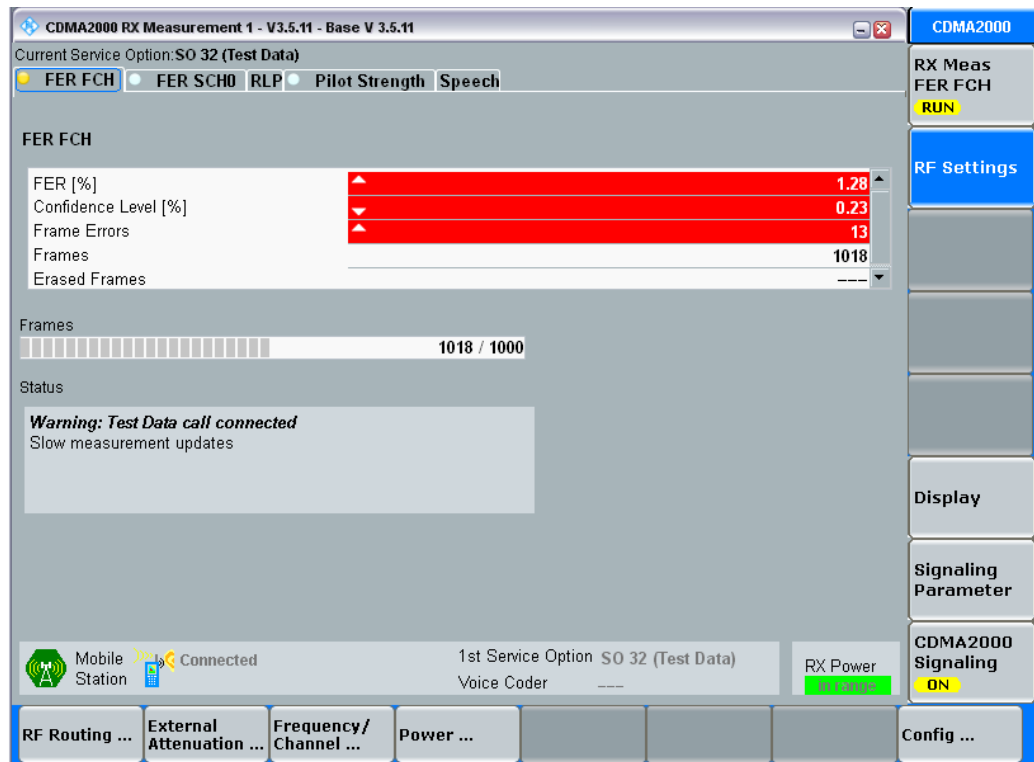

Fig. 7-9: Example for a RX measurement in CDMA2000.

### 7.1.3 CMW Internal Fading for CDMA2000

For the CDMA200 scenario:

- Standard Cell Fading

the internal fading in the CMW can be used with the software option CMW-KE800. It allows the predefined fading settings (3GPP2 C.S0032-C6.4.1 and C.S0011-C6.4.1):

- CDMA1 (8, 2 path)
- CDMA2 (30, 2 path)
- CDMA3 (30, 2 path)
- CDMA4 (100, 2 path)
- CDMA5 (0, 2 path)
- CDMA6 (3, 2 path)
- All models involve a movement of the MS. The speed of movement in km/h is indicated as part of the profile name, the number of propagation paths is also

indicated. Example: "CDMA1 (8, 2 path)" means MS moving with 8 km/h, 2 propagation paths.

8. Set the wanted **Scenario** and set **Fading** to *Internal*.

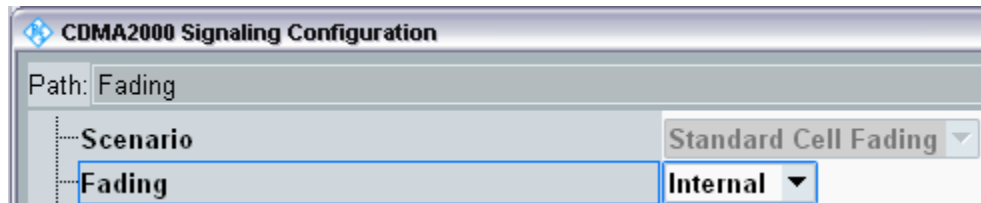

Fig. 7-10: CDMA200 scenario with internal fading

Remote commands:

```
// Standard Cell Fading external via RF2COM
ROUTE:CDMA:SIGN:SCENario:SCFading:INTernal RF2C,RX1,RF2C,TX1
```

9. Select under **Fading Simulator** the wanted *Profile* (example Case 1)

10. **Enable** the Fading

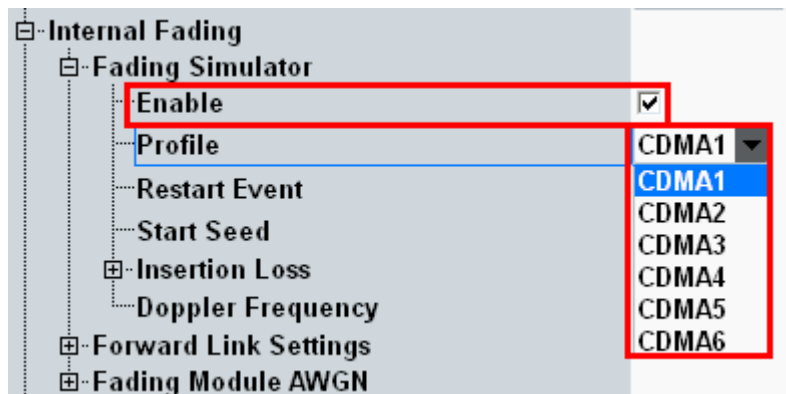

Fig. 7-11: internal CDMA200 fading profiles

Remote commands:

```
// Fading profile CDMA1 (P1)
CONFigure:CDMA:SIGN<i>:FADing:FSIMulator:STANdard P1
// Switch on FADing
CONFigure:CDMA:SIGN<i>:FADing:FSIMulator:ENABLe ON
```

11. If wanted, apply AWGN by setting the **Signal/Noise** and enable the AWGN.



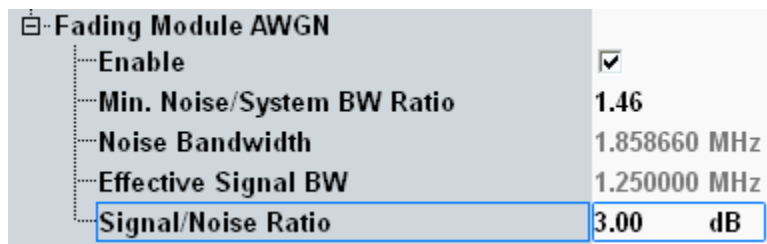

Fig. 7-12: internal CDMA2000 AWGN section

Remote commands:

```
// Ratio 1.5
CONFigure:CDMA:SIGN<i>:FADing:AWGN:BWIDth:RATIo 1.5

// Signal/Noise 5.0
CONFigure:CDMA:SIGN<i>:FADing:AWGN:SNRatio 5.0

// Switch on AWGN
CONFigure:CDMA:SIGN<i>:FADing:AWGN:ENABle ON
```

12. Start the measurement (see 7.1.1).

## 7.2 1xEV-DO

With the 1xEV-DO (3GPP2) standard, the AT receiver measurements includes a Frame Error Rate (FER), RLP, Pilot Strength and Speech measurements. All measurements are summarized in the **1xEV-DO RX Meas** measurement application (see 7.2.1).

Before starting the 1xEV-DO signaling, external fading must be selected as the scenario. Once signaling has begun, or once a connection has been established with the DUT, it is no longer possible to change scenarios.

This section describes the necessary steps to perform a 1xEV-DO Rx measurement.

The CMW supports all revisions of the standard:

Revisions			
Revision	PHY subtype	Max Data (Mbit/s) Forward Link	Comments
Release 0	0	2.4	
Revision A	1 and 2	3.1	
Revision B	1, 2 and 3	4.9 per carrier	CMW supports up to 3 carriers

1xEV-DO controls the data rate in the forward link by Data Rate Control (DRC). Please see [12] for more information and [11] how to set up the data rate in the CMW.

In Rev. B the CMW supports up to three carriers. As all carriers are generated in one baseband in the CMW and thus routed in the fading scenario via only one Digital IQ output to the SMW, it is not possible to apply fading to both carriers independently.

## 7.2.1 Access Terminal Receiver Measurement in 1xEV-DO: Rx Meas

### PER

Here the Packet Error Rate in the Forward Link is determined. Views of both channels are analogical.

For multi-carrier tests (revision B, physical layer subtype 3) PER statistics are collected and displayed both for the individual carriers and for all active carriers (column "Composite").

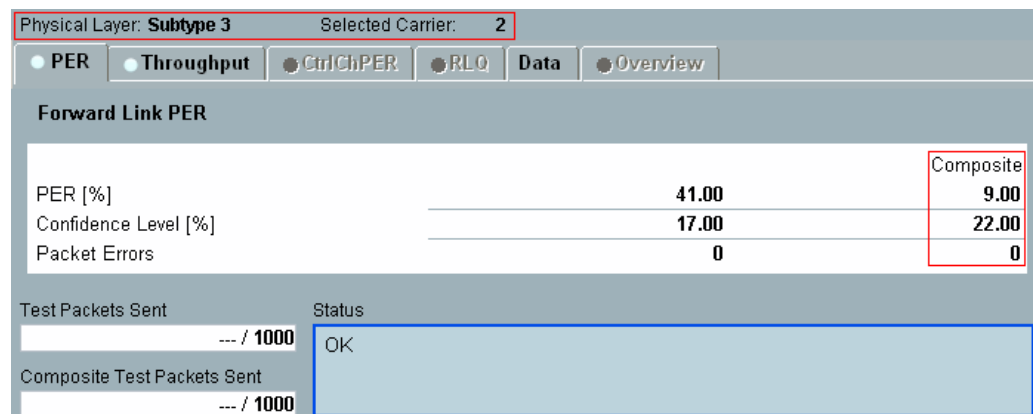

Fig. 7-13: Packet Error rate measurement in 1xEV-DO

### Remote commands:

```
INITiate:EVDO:SIGN<i>:RXQuality:FLPer // start measurement
FETCh:EVDO:SIGN<i>:RXQuality:FLPer? // get results
```

### Throughput

This tab shows the throughput on the MAC level.

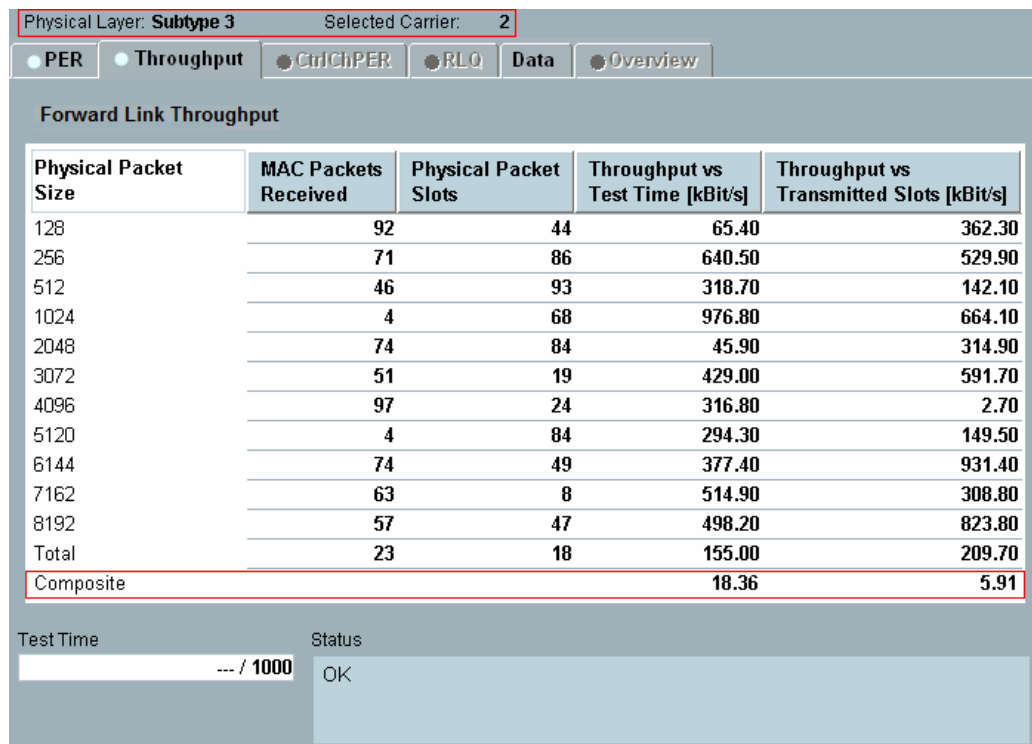

Fig. 7-14: Throughput measurements

Remote commands:

```
INITiate:EVDO:SIGN<i>:RXQuality:FLPFformance // start
measurement
FETCh:EVDO:SIGN<i>:RXQuality:FLPFformance? // get results
```

**Data**

This tab shows the RLP and IP statistics. This measurement requires an end-to-end data connection with the DAU.

RLP & IP Statistics				
RLP Messages	Rx	Rx Total	Tx	Tx Total
Reset	0	0	0	0
Reset ACK	0	0	0	0
NAK	0	1	0	0
Summary	0	1	0	0
	Rx		Tx	
PPP Total Bytes [kByte]	10177		59733	
Data Rate [kBit/s]	1087.5		2607.5	

Status  
OK

Fig. 7-15: RLP and IP statistics

Remote commands:

`SENSe:EVDO:SIGN<i>:RXQuality:IPStatistics:SUMMARY?//` get results

## 7.2.2 Fading Scenario

In 1xEV-DO fading on one path only is applied.

1. In the **1xEV-DO Signaling Configuration**, select the *Standard Cell Fading Scenario* (see Fig. 6-2). Set the **Fading** to *External*.

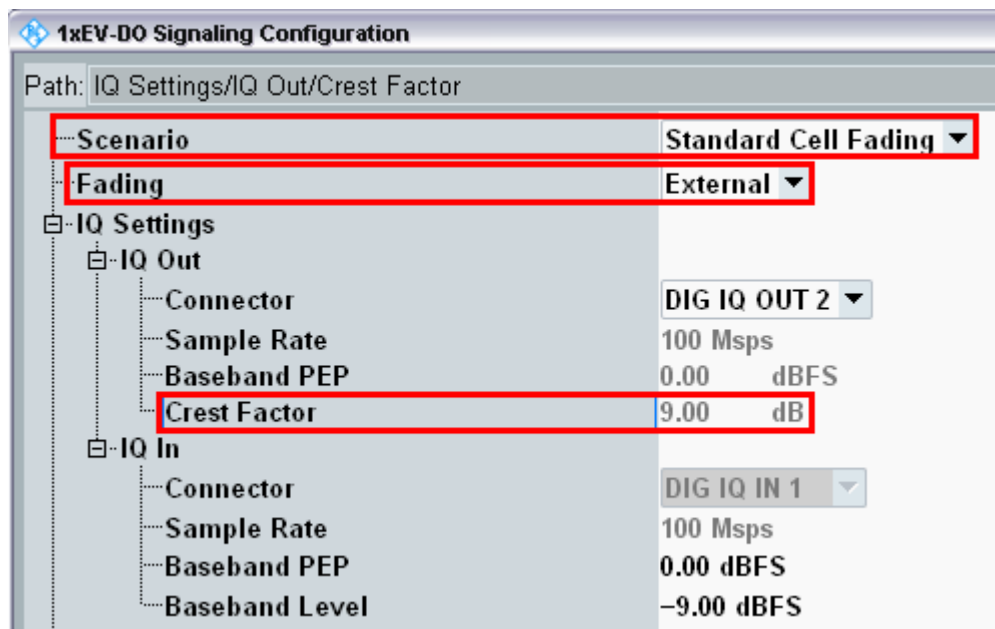

Fig. 7-16: 1xEV-DO scenario: Standard Cell Fading. The CMW indicates the crest factor, which is entered in the SMW's Dig IQ Input.

Remote commands:

```
// Standard Cell Fading external via RF2COM and IQ2 Out
ROUTE:EVDO:SIGN:SCENario:SCFading RF2C,RX1,RF2C,TX1,IQ2O
// read out information of IQ settings
SENSe:EVDO:SIGN<i>:IQOut:PATH<n>?
```

2. Take note of the **Crest Factor** under **IQ Out** and enter this value in the SMW under **Baseband Input Level** (see Fig. 2-13 in section 2.3).
3. Set a fading and switch on **I/Q Out** (BBMM1)(see section 2.3).
4. In the CMW, enter the corresponding baseband level (Level BB<sub>out</sub>SMW= Crest Factor<sub>In</sub>SMW – Insertion Loss; example: -9.0 dB – 10 dB = -19.0 dBFS, see 2.3.8), which is indicated by the SMW (see Fig. 7-18). If you add noise to the signal, note the crest factor without noise.
5. Use **CONNECT** to establish a 1xEV-DO connection between the CMW and DUT.
6. If you modify the fading, remember to change the level accordingly in the CMW.

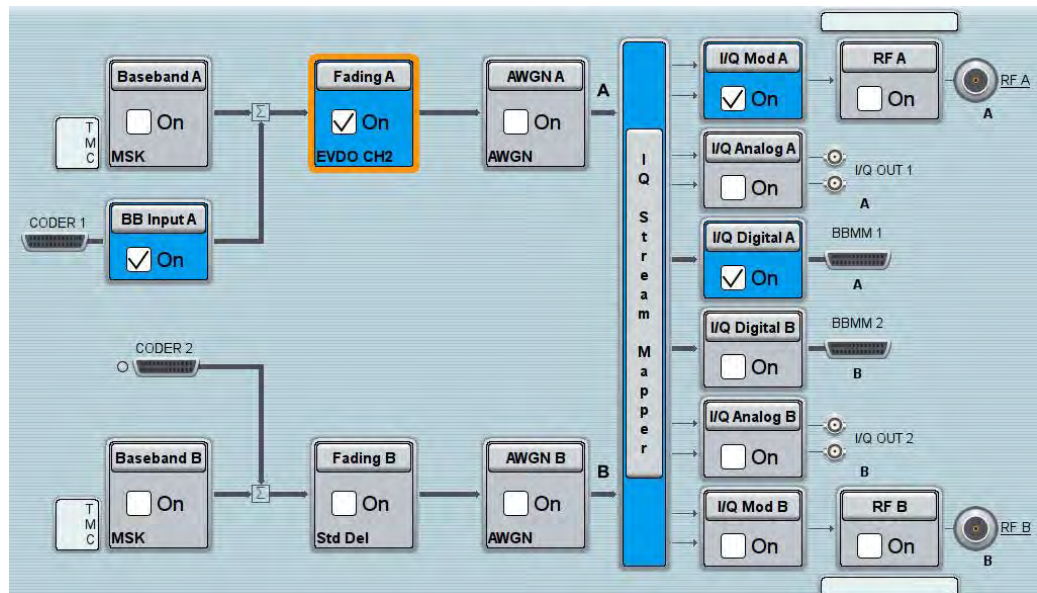

Fig. 7-17: Overview SMW settings for 1xEV-DO.

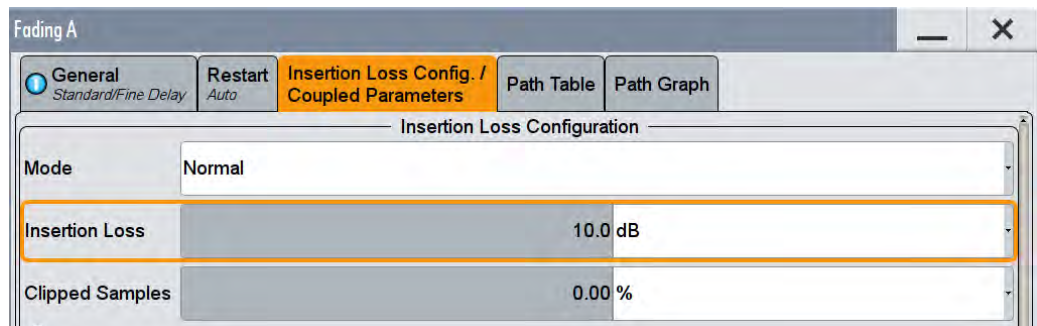

Fig. 7-18: The SMW shows the necessary insertion loss (example: 10 dB)

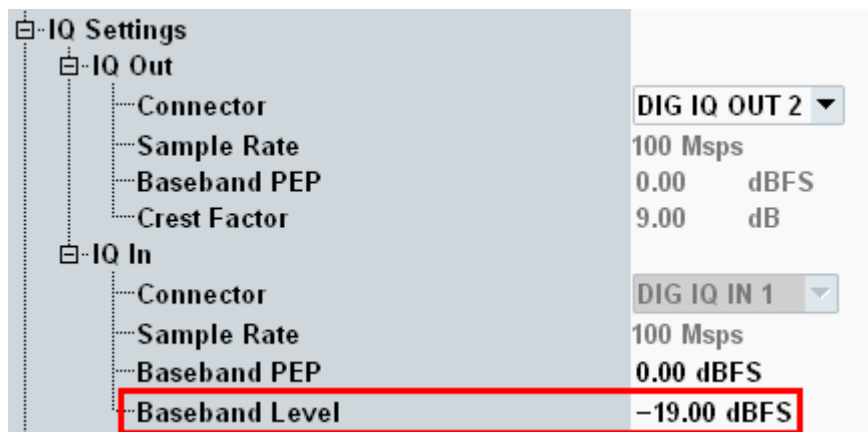

Fig. 7-19: Making allowance for the necessary attenuation in the CMW. Here, the digital output level of the SMW signal is entered as the IQ In level.

Remote command:

```
// set IQ In to PEP 0 dBFS and Level -19.0 dBFS
CONFigure:EVDO:SIGN<i>:IQIN:PATH<n> 0.0, -19.0
```

7. Start the RX measurement using **Rx MEAS** (see section 7.2.1). Fig. 7-20 shows an example.

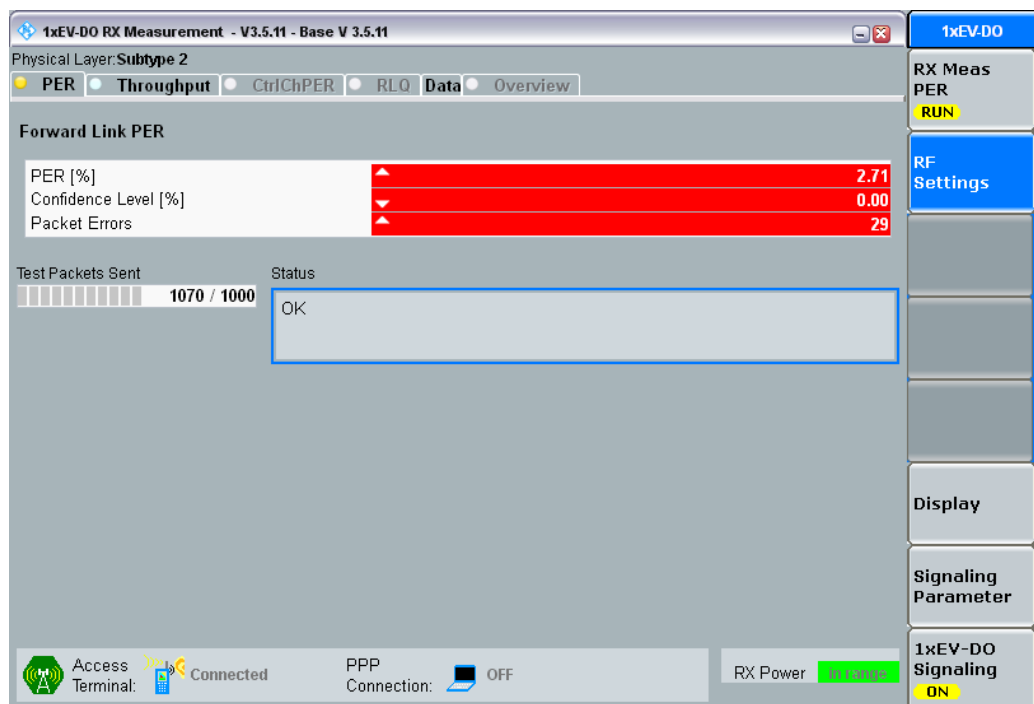

Fig. 7-20: Example for a RX measurement in 1xEV-DO.

### 7.2.3 CMW Internal Fading for 1xEV-DO

For the 1xEV-DO scenario:

- Standard Cell Fading

the internal fading in the CMW can be used with the software option CMW-KE800. It allows the predefined fading settings (3GPP2 C.S0032):

- EVDO1 (8, 2 path)
- EVDO 2 (3, 1 path)
- EVDO 3 (30, 1 path)
- EVDO 4 (100, 3 path)
- EVDO 5 (0, 2 path)
- All models involve a movement of the AT. The speed of movement in km/h is indicated as part of the profile name, the number of propagation paths is also indicated. Example: "EVDO1 (8, 2 path)" means AT moving with 8 km/h, 2 propagation paths.

8. Set the wanted **Scenario** and set **Fading** to *Internal*.



Fig. 7-21: CDMA2000 scenario with internal fading

Remote commands:

```
// Standard Cell Fading external via RF2COM
ROUTE:EVDO:SIGN:SCENARIO:SCFading:INTERNAL RF2C,RX1,RF2C,TX1
```

9. Select under **Fading Simulator** the wanted *Profile* (example Case 1)
10. **Enable** the Fading

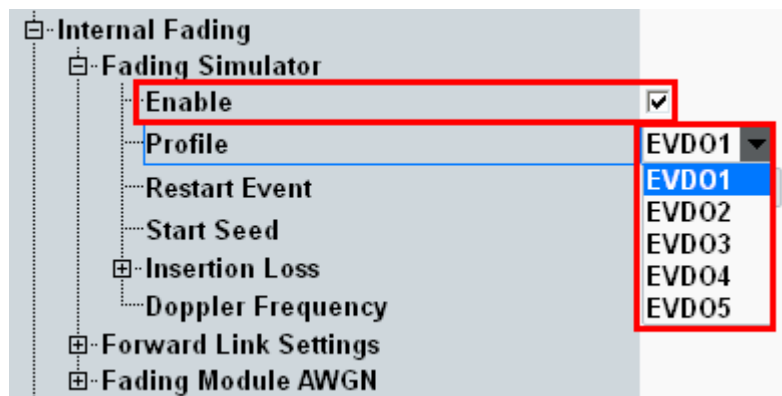

Fig. 7-22: internal 1xEV-DO fading profiles

Remote commands:

```
// Fading profile EVD01 2 paths
CONFigure:EVDO:SIGN<i>:FADing:FSIMulator:STANdard P1
// Switch on FADing
CONFigure:EVDO:SIGN<i>:FADing:FSIMulator:ENABLe ON
```

11. If wanted, apply AWGN by setting the **Signal/Noise** and enable the AWGN.

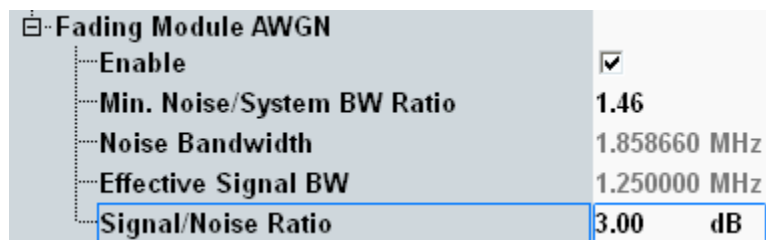

Fig. 7-23: internal 1xEV-DO AWGN section

Remote commands:

```
// Ratio 1.5
CONFigure:EVDO:SIGN<i>:FADing:AWGN:BWIDth:RATIo 1.5

// Signal/Noise 5.0
CONFigure:EVDO:SIGN<i>:FADing:AWGN:SNRatio 5.0

// Switch on AWGN
CONFigure:EVDO:SIGN<i>:FADing:AWGN:ENABLe ON
```

12. Start the measurement (see 7.2.1).



## 8 Data Application Unit (DAU)

Applications with the DAU can also employ external fading. Doing this only requires taking a few steps beyond the steps described earlier in this document:

1. Enable end-to-end data connections in the individual radio access networks (RANs).

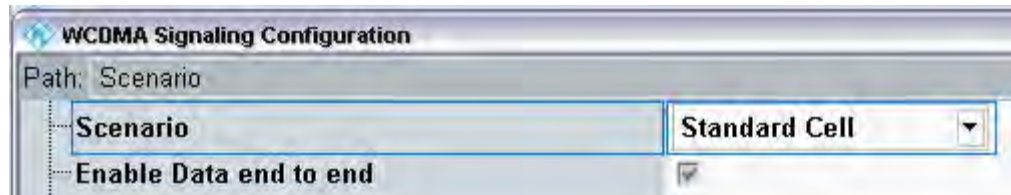

Fig. 8-1: *Enable Data end-to-end* must already be activated in the individual RANs (in this example, for WCDMA).

Note: Certain RANs do not show this setting in newer firmware versions. In this case the CMW starts Data end to end functionality automatically.

```
// ENABLE <STANDARD> END TO END, EXAMPLE: WCDMA
CONFigure:WCDMA:SIGN<i>:ETOE ON
```

2. Configure the DAU (see below).
3. From the UE, establish an end-to-end connection (no test mode).
4. Perform the measurements (e.g. directly in the device or with special end-to-end-measurements) on the CMW.

For further information on operating the DAU, please refer to [7].

The DAU application **IPERF** sends data packages with a defined data rate to the UE. It is used for the following BLER and throughput measurement.

1. Press the MEASURE button on the CMW and check Data Appl. → Measurements 1.

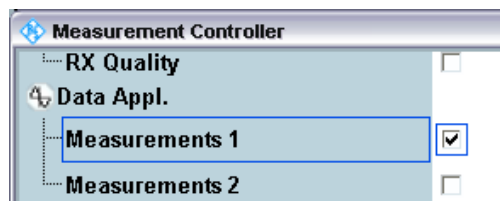

Fig. 8-2: Select DAU menu.

2. Press the **DATA 1 MEAS** software tab to enter the DAU Menu.
3. Select the iPerf menu tab.

4. Press **CONFIGURE SERVICES** software key.
5. In the **DATA APPLICATION CONTROL** window, select the **IP CONFIG** tab and use following settings. Close the window.

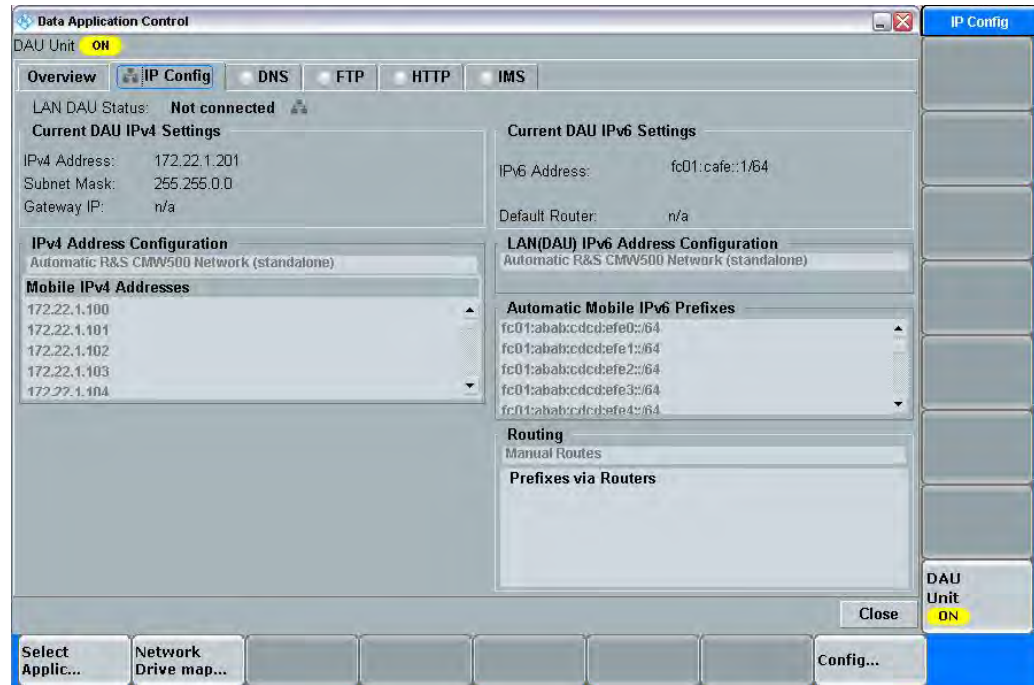

Fig. 8-3: The IP Config menu.

6. In the **DATA APPLICATION MEASUREMENTS 1** window select **IPERF** and press the **CONFIG...** software key.

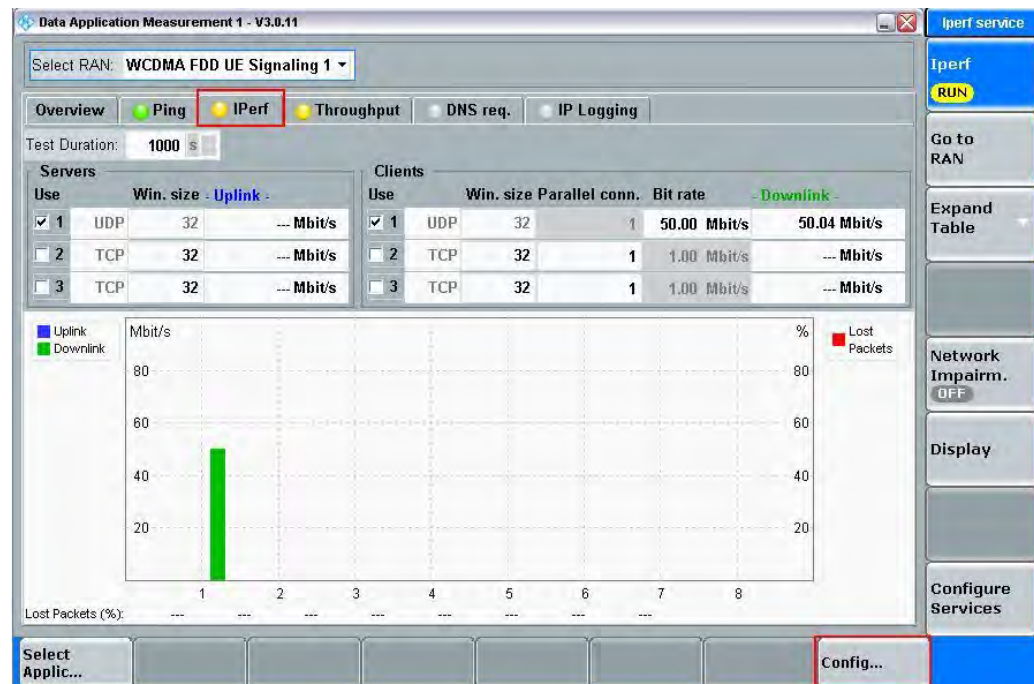

Fig. 8-4: Running IPERF.

7. In the **IPERF CONFIG** window, select **CLIENT #1**, **UDP** and **BIT RATE = e.g. 50 Mbit/s** (must be  $\leq$  DL IP data rate). This sets the Downlink data rate. Press Ok to return to the **DATA APPLICATION MEASUREMENTS 1** window.

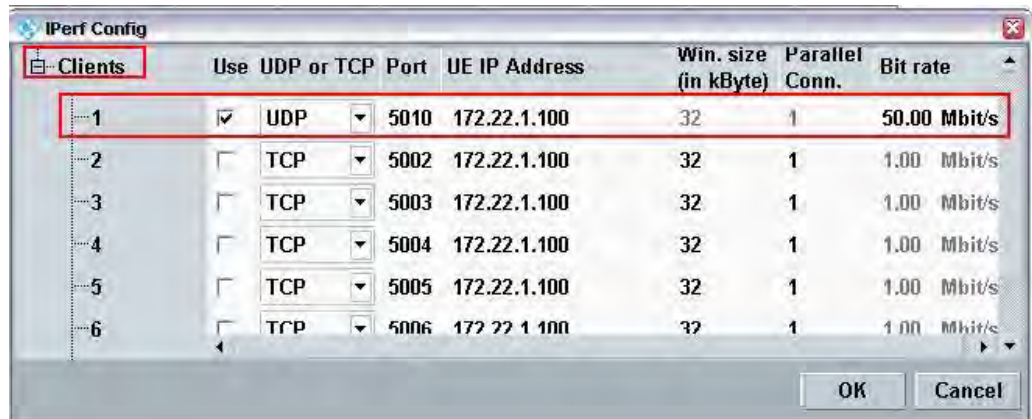

Fig. 8-5: IPerf Config window.

8. Press the Iperf software key and press the ON/OFF button. The yellow RUN status message indicates that the data generator is running.



Fig. 8-6: Iperf is running.

#### Remote commands:

##### Configuration:

TEST DURATION – Time the test should last (in seconds).

`CONFigure:DATA:MEAS1:IPERf:TDURation 1000`

PORT NUMBER – Data Application Unit (LAN DAU) port number for the connection.

`CONFigure:DATA:MEAS1:IPERf:CLient1:PORT 5001`

WINDOW SIZE – Size of the Negative Acknowledgement (NACK) window (in kbyte).

`CONFigure:DATA:MEAS1:IPERf:CLient1:WSIZE 32`

LISTEN PORT – UE's listen port number for the connection.

`CONFigure:DATA:MEAS1:IPERf:CLient1:LPORT`

BITRATE – Maximum bit rate to be transferred (in kbps).

`CONFigure:DATA:MEAS1:IPERf:CLient1:BITRate 56M`

PROTOCOL – Specifies the protocol used for data transfer for the client connection.

`CONFigure:DATA:MEAS1:IPERf:CLient1:PROTOCOL UDP`

IPADDRESS – Specifies the IP address of an IPerf client.

`CONFigure:DATA:MEAS1:IPERf:CLient1:IPAddress 172.22.1.100`

ENABLE – Activates an IPerf client instance.

`CONFigure:DATA:MEAS1:IPERf:CLIENT1:ENABLE ON`

##### Start/Stop generating data:

`INIT:DATA:MEAS1:IPERf`

`STOP:DATA:MEAS1:IPERf`

`ABORT:DATA:MEAS1:IPERf`

9. Measure the throughput in the DAU application directly.

## 8.1 LTE

For LTE, there is one special setting for end-to-end tests.

Under **Connection**, the **Type** must be set to *Data Application* (Fig. 8-7).

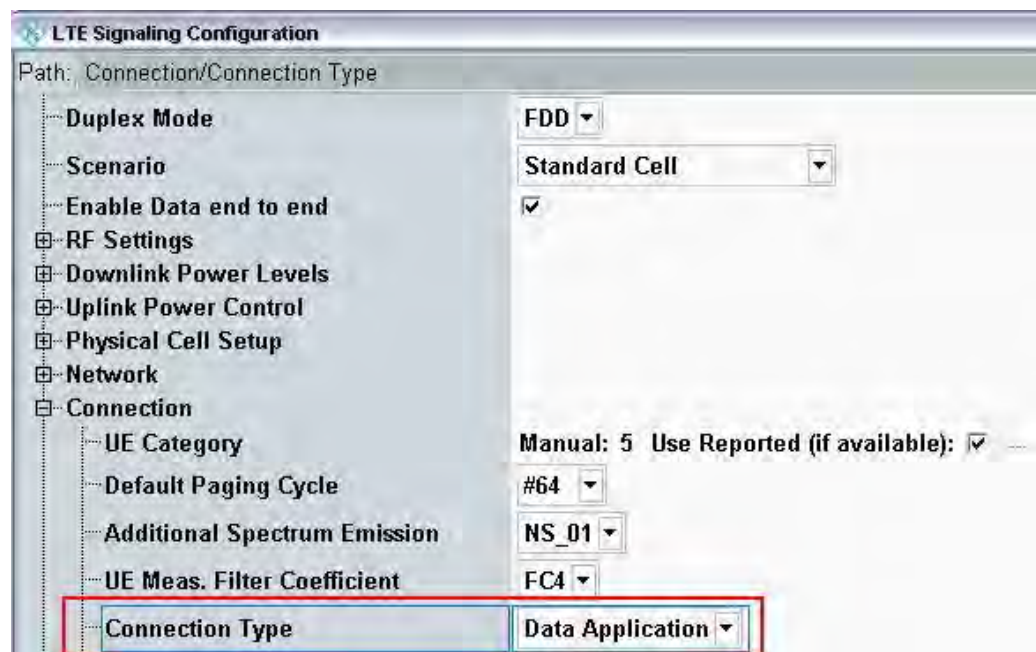

Fig. 8-7: LTE special Settings for end-to-end tests: Data Application.

Remote command:

```
// SET CONNECTION TYPE TO DATA APPLICATION
CONFigure:LTE:SIGN<i>:CONNECTION:CTYPE DAPplication
```

## 8.2 W-CDMA and with HSPA(+)

For W-CDMA, there are several special settings for end-to-end tests.

Under **Packet Data**, HSDPA or HSUPA should be entered under *Data Rate* (Fig. 8-8).

Here, too, the **WCDMA Wizard** is available for automatic setup using the UE capability (see Fig. 4-1 on page 77).

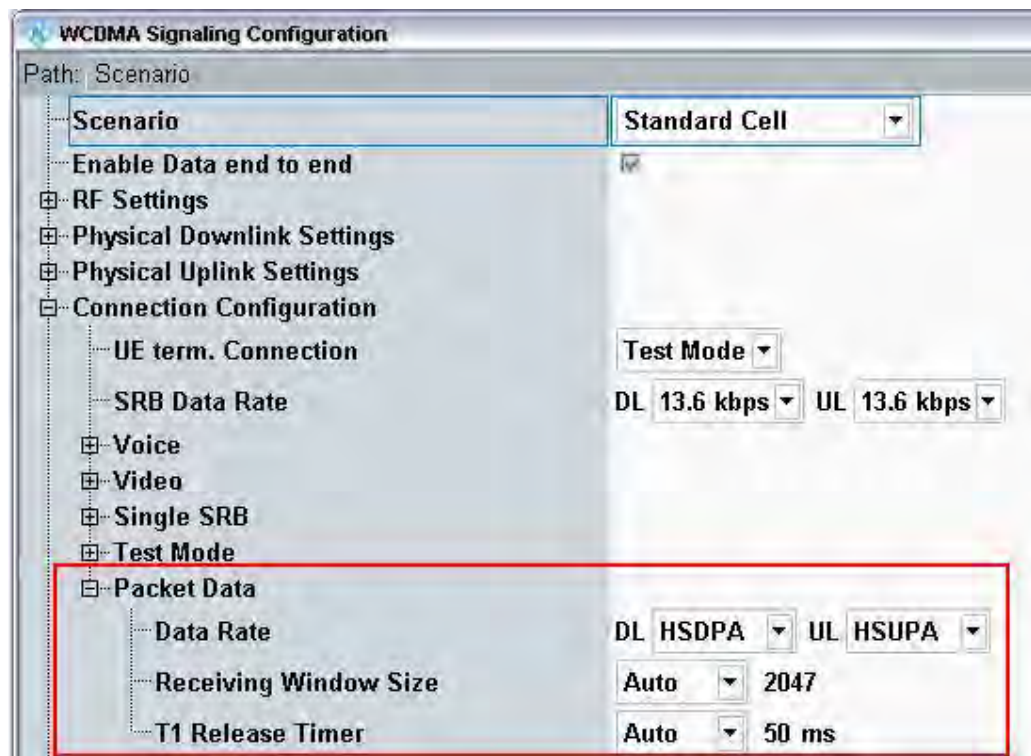

Fig. 8-8: W-CDMA special settings for end-to-end tests: Packet data.

Remote command:

```
// ENABLE WCDMA END TO END
CONFIGure:WCDMa:SIGN<i>:ETOE ON
// SET PACKET DATA DATA RATE TO HSDPA AND HSUPA
CONFIGure:WCDMa:SIGN<i>:CONNECTION:PACKet:DRATe HSDPa, HSUPa
```

The W-CDMA option offers an additional throughput measurement based on end-to-end data connections (RLC throughput, see section 4.1). The HSDPA ACK and E-HICH receiver measurements for Layer1 (under RX Meas, see section 4.1) also work in the end-to-end configuration. Beyond this, all Tx tests can also be used with end-to-end connections.

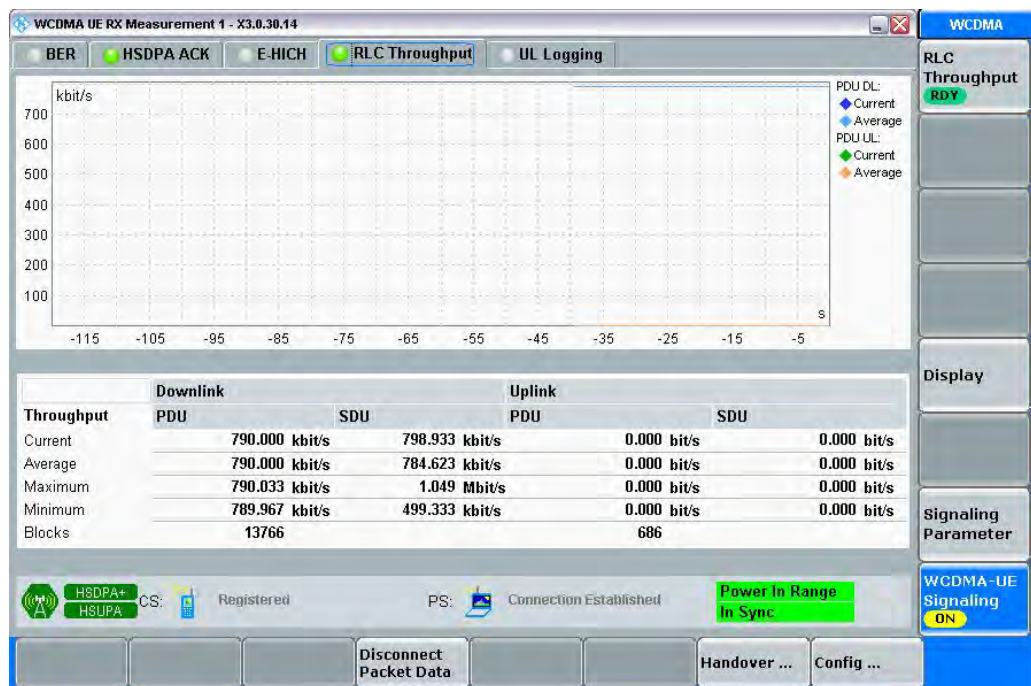
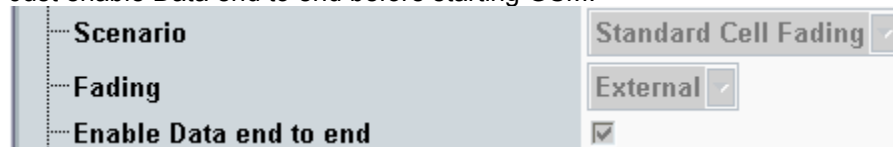

Fig. 8-9: RLC throughput measurements in WCDMA. Here, the throughput is measured directly in the end-to-end connection.

### 8.3 GSM and (E)GPRS(2)

For GSM, there is no special setting necessary for end-to-end tests.

Just enable Data end to end before starting GSM.



Remote command:

```
// ENABLE GSM END TO END
CONFigure:GSM:SIGN<i>:ETOE ON
```

The GSM option offers an additional throughput measurement based on end-to-end data connections (RLC throughput, 5.1). Beyond this, all Tx tests can also be used with end-to-end connections.

### 8.4 TD-SCDMA

For TD-SCDMA, there are several special settings for end-to-end tests.

Under **Packet Data**, enter the wanted *Data Rate* ( Fig. 8-10). Make sure that the Packet switched domain is enabled (Fig. 8-11).

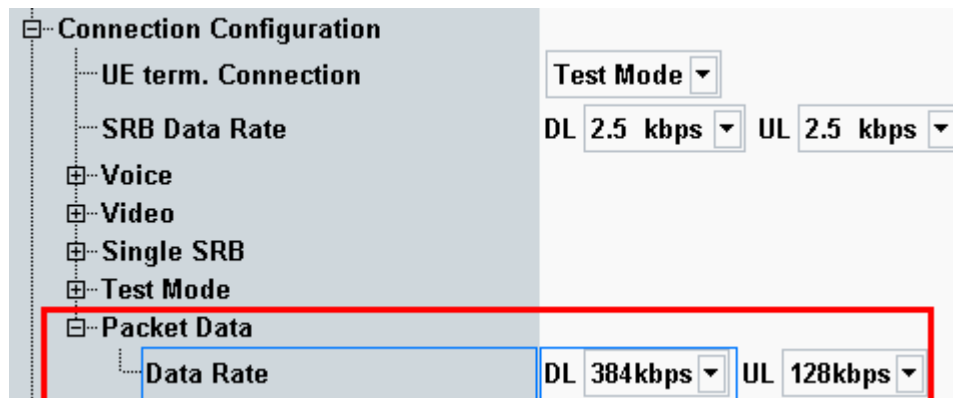

Fig. 8-10: TD-SCDMA special settings for end-to-end tests: Packet data.

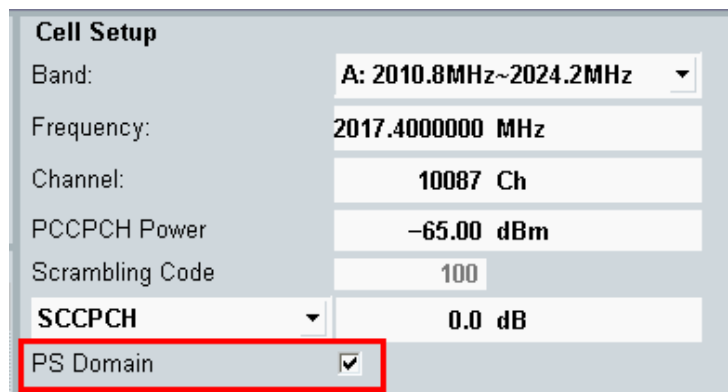

Fig. 8-11: PS domain

Remote command:

```
// ENABLE TD-SCDMA END TO END
CONFigure:TDSCdma:SIGN<i>:ETOE ON
// ENABLE PS DOMAIN
CONFigure: TDSCdma:SIGN<i>:CELL:PSDomain ON
// SET PACKET DATA DATA RATE
CONFigure: TDSCdma:SIGN<i>:CONNECTION:PACKet:DRATe R384,R128
```

Use the throughput measurement in the DAU (see 8). Beyond this, all Tx tests can also be used with end-to-end connections.

## 8.5 CDMA2000 and 1XEV-DO

### CDMA2000

For CDMA2000, there are several special settings for end-to-end tests.

First, the **SO** has to be **SO33 (Packet Data)**. In Service Configuration, set **Accept Packet Calls to Accept** as the AT sets up the connection (Fig. 8-12).

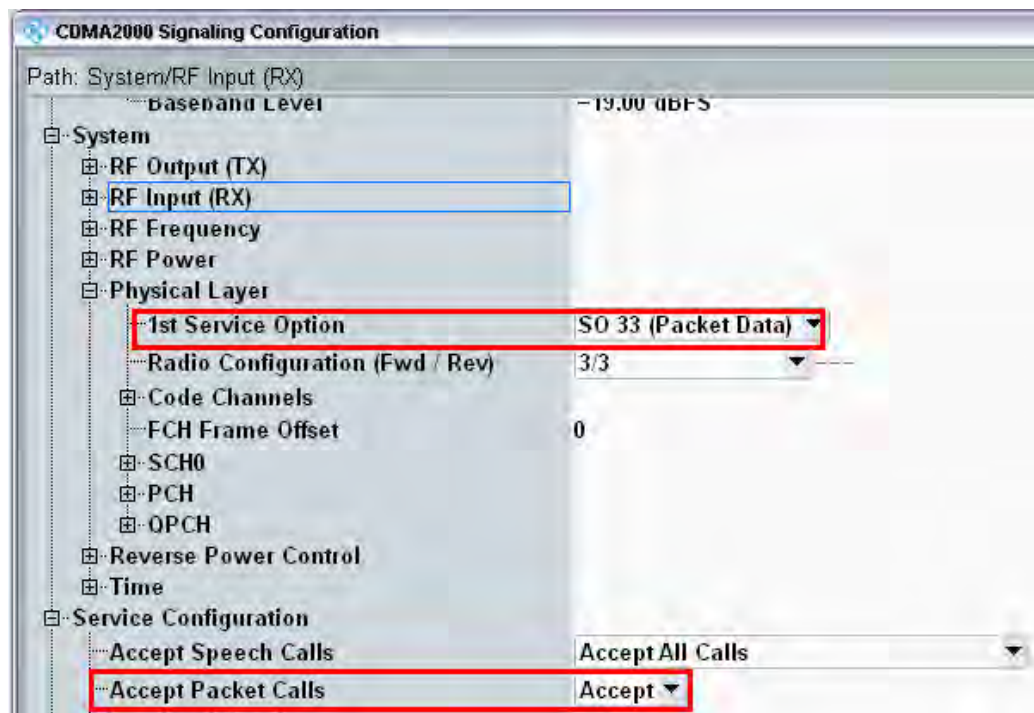

Fig. 8-12: CDMA2000 special settings for end-to-end tests.

Remote command:

```
// SET SO 33
CONFigure:CDMA:SIGN<i>:PREConfiguration:LAYer:SOPTion:FIRSt SO33
// ACCEPT PACKET CALLS
CONFigure:CDMA:SIGN<i>:SCONfig:APCalls ACCEpt
```

Use the throughput measurement in the DAU (see 8). Beyond this, all Tx tests can also be used with end-to-end connections.

### 1xEV-DO

For 1xEV-DO, there is one special setting for end-to-end tests.

Set the **Application** to **Packet** (Fig. 8-13).



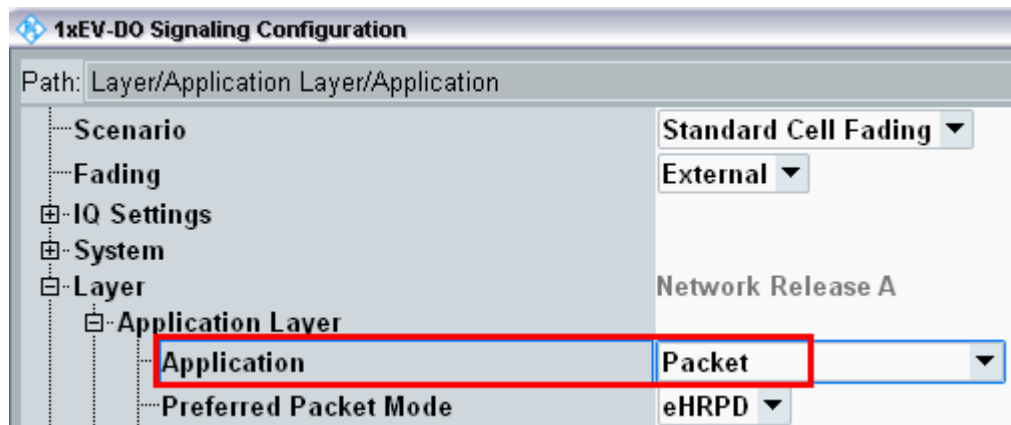

Fig. 8-13: 1xEV-DO special settings for end-to-end tests.

Remote command:

```
// SET APPLICATION PACKET  
CONFigure:EVDO:SIGN<i>:APPLication:MODE PACKET
```

Use the throughput measurement in the DAU (see 8). Beyond this, all Tx tests can also be used with end-to-end connections.

## 9 Appendix

### 9.1 Literature

- [1] Application Note 1MA111, [UMTS Long Term Evolution \(LTE\) Technology Introduction](#)
- [2] Application Note 1MA142, [Introduction to MIMO](#)
- [3] Application Note 1GP51 [Guidelines for MIMO Test Setups – Part 2](#)
- [4] Application Note 1SP11 [WiMAX MIMO Multipath Performance Measurements](#)
- [5] User Manual, R&S®CMW-KM5xx/-KS5xx LTE Firmware Applications
- [6] User Manual, R&S®CMW-KG4xx/-KM4xx/-KS4xx WCDMA Firmware Applications
- [7] User Manual, R&S®CMW-B450A/-KM050 Data Application Units
  
- [8] Application Note 1MA177 [LTE Terminal Tests under Fading Conditions with R&S®CMW500 and R&S®AMU200A](#)
- [9] User Manual, R&S®CMW-KM2xx/-KS2xx GSM Firmware Applications
- [10] User Manual, R&S®CMW-KM75x/-KS750/KS760 TD-SCDMA Firmware Applications
- [11] User Manual, R&S®CMW-KM8xx/-KS8xx CDMA2000 1xRTT and 1xEV-DO Firmware Applications
- [12] White Paper 1MA213 [1xEV-DO Revision A + B](#)

### 9.2 Additional Information

Please send your comments and suggestions regarding this application note to

[TM-Applications@rohde-schwarz.com](mailto:TM-Applications@rohde-schwarz.com)

## 9.3 Ordering Information

Ordering Information		
<b>CMW Wideband Radio Communication Tester</b>		
<b>CMW500 RF Tester Hardware configuration</b>		
<b>Base Unit</b>	<b>CMW500</b>	<b>1201.0002K50</b>
CMW500 Mainframe 03	CMW-PS503	1208.7154.02
Front Panel with Display H600B	CMW-S600B	1201.0102.03
BB Flexible Link H550B	CMW-S550B	1202.4801.03
RF Frontend (Basic) H590A	CMW-S590A	1202.5108.02
2 <sup>nd</sup> RF Frontend (Basic) H590A	CMW-B590A	1202.8707.02
<b>Or</b>		
RF Frontend, advanced functionality	CMW-S590D	1202.5108.03
DVI Interface	CMW-B620A	1202.5808.02
Option Carrier H660A	CMW.B660A	1202.7000.02
Ethernet Switch H661A	CMW-B661A	1202.7100.02
OCXO (Highly Stable) H690B	CMW-B690B	1202.6004.02
Signaling Unit Wideband H300A	CMW-B300A	1202.8759.02
Signaling Unit Universal B200A	CMW-B200A	1202.6104.02
GSM Signaling option	CMW-B210A	1202.6204.02
Extra RF Converter H570A	CMW-B570B	1202.8659.03
Data Application Unit	CMW-B450A	1202.8759.02
Digital IQ 1 to 4	CMW-B510F	1202.8007.07
Digital IQ 5 to 8	CMW-B520F	1202.8107.07
Basic Fading and AWGN	CMW-KE100	1207.5506.02
<b>Software LTE RF Tester</b>		
LTE FDD Rel. 8, SISO, Basic signaling	CMW-KS500	1203.6108.02
LTE Rel. 8, SISO, advanced signaling	CMW-KS510	1203.9859.02
LTE MIMO 2x2 signaling	CMW-KS520	1207.3555.02
LTE, user defined bands signaling	CMW-KS525	1207.4000.02
LTE TDD Rel. 8, SISO, Basic signaling	CMW-KS550	1204.8904.02
LTE FDD Rel. 8, TX measurement, uplink	CMW-KM500	1203.5501.02
LTE TDD Rel. 8, TX measurement, uplink	CMW-KM550	1203.8952.02
LTE FDD R10, CA, basic signaling	CMW-KS502	1208.6029.02
LTE R10, CA, adv. signaling	CMW-KS512	1208.6041.02
LTE TDD R10, CA, basic signaling	CMW-KS552	1208.6087.02
LTE fading profiles MIMO 4x2	CMW-KE500	1207.5658.02

LTE fading profiles MIMO 4x2	CMW-KE501	1208.6812.02
<b>Software W-CDMA RF Tester</b>		
WCDMA Rel. 99, Basic signaling	CMW-KS400	1203.0751.02
WCDMA Rel. 99, advanced signaling	CMW-KS410	1203.9807.02
WCDMA Rel. 5/6 HSPA, basic signaling	CMW-KS401	1203.9907.02
WCDMA Rel. 5/6 HSPA, advanced signaling	CMW-KS411	1207.3503.02
WCDMA Rel. 7 HSPA+, SISO, Basic signaling	CMW-KS403	1203.9959.02
WCDMA Rel. 7 HSPA+, SISO, adv. signaling	CMW-KS413	1207.3755.02
WCDMA Rel. 8 DC-HSDPA, Basic signaling	CMW-KS404	1207.6154.02
WCDMA Rel. 9 HSPA+, Basic signaling	CMW-KS405	1208.5980.02
WCDMA, user-defined bands,	CMW-KS425	1207.3955.02
WCDMA Rel. 99, TX measurement, uplink	CMW-KM400	1203.0700.02
WCDMA Rel. 5/6 HSPA, TX measurement, uplink	CMW-KM401	1203.2954.02
WCDMA Rel. 7 HSPA+, TX measurement, uplink	CMW-KM403	1203.9007.02
WCDMA fading profiles	CMW-KE400	1207.5606.02
<b>Software GSM RF Tester</b>		
GSM GPRS EDGE Rel. 6, Basic signaling	CMW-KS200	1203.0600.02
GSM GPRS EDGE Rel. 6, advanced signaling	CMW-KS210	1203.9759.02
GSM Rel.7, EDGEevo, Basic signaling	CMW-KS201	1204.8504.02
GSM Rel. 9, VAMOS	CMW-KS203	1207.2759.02
GSM GPRS EDGE Rel. 6 Tx measurement	CMW-KM200	1203.0551.02
GSM Rel. 7 EGPRS2-A Tx measurement	CMW-KM201	1204.8404.02
GSM fading profiles	CMW-KE200	1207.5558.02
<b>Software TD-SCDMA RF Tester</b>		
TD-SCDMA R4, basic signaling	CMW-KS750	1208.7854.02
TD-SCDMA R4, advanced signaling	CMW-KS760	1208.7854.02
TD-SCDMA, TX measurement	CMW-KM750	1203.2554.02
TD-SCDMA enhancement, TX measurement	CMW-KM751	1207.6102.02
<b>Software CDMA2000 / 1xEV-DO RF Tester</b>		
CDMA2000® 1xRTT, basic signaling	CMW-KS800	1203.3109.02
CDMA2000® 1xRTT, adv. Signaling	CMW-KS810	1207.3603.02
CDMA2000® 1xEV-DO Rev. 0/A, basic signaling	CMW-KS880	1203.3209.02
CDMA2000® 1xEV-DO Rev. B, basic signaling	CMW-KS881	1207.3655.02
CDMA2000® 1xEV-DO Rev. 0/A, adv. signaling	CMW-KS890	1207.3703.02
CDMA2000® 1xRTT, TX measurement	CMW-KM800	1203.2602.02
CDMA2000® 1xEV-DO Rev. 0/A/B, TX meas.	CMW-KM880	1203.2854.02

C2K and EVDO fading profiles	CMW-KE800	1208.6858.02
<b>IP Test Extension</b>		
Enabling of IP-Data Interface for IPV4	CMW-KA100	1207.2607.02
Extension of IP-Data Interface to IPv6	CMW-KA150	1207.2659.02
IP Based Measurements	CMW-KM050	1203.5901.02
<b>Optional</b>		
Mini USIM LTE Rel. 8	CMW-Z03	1202.9503.02
<b>RF Combiner</b>		
Multibox RF set	CMW-Z24	1508.6150.02

Ordering Information		
<b>Fading Simulator</b>		
<b>SMW200A Vector Signal Generator</b>		
<b>Base Unit</b>	<b>SMW200A</b>	<b>1412.0000.02</b>
Baseband Main Module, two IQ paths	SMW-B13T	1413.3003.02
Digital Baseband Outputs	SMW-B18	1413.3432.02
Fading Simulator	SMW-B14	1413.1500.02
Additional White Gaussian Noise	SMW-K62	1413.3484.02
Dynamic Fading	SMW-K71	1413.3532.02
MIMO Fading	SMW-K74	1413.3632.02

Note: The Rx measurements like BER/BLER/Throughput are included in the signaling options. Thus, the mentioned Tx measurements options are not necessary for the Rx tests.